



BOHREN UND REIBEN

DRILLING AND REAMING

2025/2026



ERLEBEN SIE HORN
EXPLORE HORN

Erleben Sie HORN

Herausragende Ergebnisse sind immer die Kombination aus optimalem Zerspanungsprozess und perfektem Werkzeug. HORN verbindet dafür Spitzentechnologie, Leistungsfähigkeit und Zuverlässigkeit. Von der Einzelteil- bis zur Serienfertigung, für Standard- oder Sonderanwendungen: Unsere Werkzeuge bieten Ihnen schnelle, wirtschaftliche und qualitativ hochwertige Lösungen. Bei der Auswahl der individuellen Schnittparameter unterstützen Sie unsere Tabellen mit praxiserprobten Erfahrungswerten im jeweiligen Katalog. Nutzen Sie darüber hinaus das Know-how unserer Mitarbeiterinnen und Mitarbeiter im Innen- und Außendienst.

Nachhaltigkeit ist ein zentraler Bestandteil unserer Unternehmensphilosophie. Deshalb stehen Qualitätssicherung, Umweltschutz, Energieeffizienz und Sicherheit bei unseren Produkten und in der Produktion seit jeher im Fokus. Als leistungsstarker und zuverlässiger Werkzeugpartner sorgen wir dafür, dass Sie mit uns gemeinsam in eine innovative und wirtschaftliche Zukunft gehen.

Besuchen Sie auch unseren eShop, der Ihnen rund um die Uhr zur Verfügung steht.



Markus Horn
Geschäftsführer
Paul Horn GmbH



Matthias Rommel
Geschäftsführer
Paul Horn GmbH

Explore HORN

Outstanding results are always a combination of the optimum cutting process and the perfect tool. To achieve this, HORN combines advanced technology, performance and reliability. From single part to series production, for standard or special applications: Our tools offer you fast, economical, high quality solutions. To assist you when choosing cutting parameters, our tables in the respective catalogue provide proven empirical values. Take advantage of the expertise of our office staff and sales engineers.

Sustainability is a central part of our corporate philosophy. That is why we have always focused on quality assurance, environmental protection, energy efficiency and safety with regard to our products and our production. As an efficient and reliable tool partner, we make sure that you join us in an innovative and strong economic future.

Please visit our eShop, which is available around the clock.



Markus Horn
CEO
Paul Horn GmbH



Matthias Rommel
CEO
Paul Horn GmbH











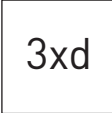

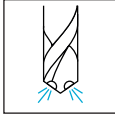
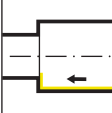
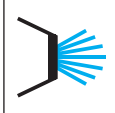
A	VHM-Bohrwerkzeuge Solid Carbide Drills		A
B	Formbohren System Form boring system	117	B
C	Bohrung-Drehen System Boring and profiling system	105	C
D	Ausspindeln mit Feinbohrkopf Boring with fine boring head	URMA	D
E	Axialeinstechen Face grooving	URMA IntraMax	E
F	Hochleistungsreiben High-performance reaming	DR	F
G	System-Aufnahmen System adaptors	URMA	G
H	Hydrodehnspannfutter Hydraulic expansion toolholder		H
I	Pendelhalter Additional equipment	PZ	I
J	Technische Hinweise, Zubehör Technical information, additional Equipment		J

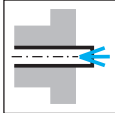
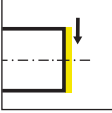
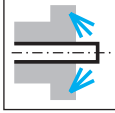
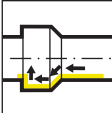
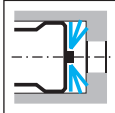
INDEX

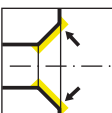
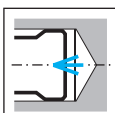
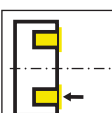
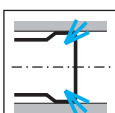
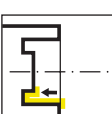
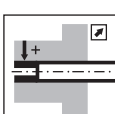
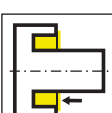
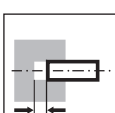
Übersicht Anwendungen

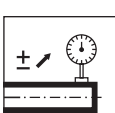
Overview Application

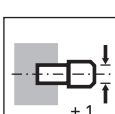

	Bohrtiefen 3xd, 5xd, 8xd Depth of bore		Spitzenwinkel 140°, 135° Point angle
	Werkstoff P, M, K, N, H Material		Innenkühlung Bohren Internal coolant drilling
	Bohrung Ausdrehen innen Internal boring		Innenkühlung Internal coolant
	Längsdrehen außen External side turning		Zwischenbüchse kühlmitteldicht Intermediate sleeve coolant tight
	Plandrehen Face turning		Peripheriekühlung Zwischenbüchse Intermediate sleeve peripheral cooling
	Bohrung Kontur Ausdrehen Boring and profiling		Kühlung für Schulterbohrung Coolant for shoulder boring
	Drehen innen Fase Internal boring and grooving chamfer		Kühlung für Sacklochbohrung lateral Coolant for blind hole lateral
	Fasen innen Internal chamfering		Kühlung für Sacklochbohrung zentral Coolant for blind hole central
	Axialstechen Face grooving		Kühlung für Durchgangsbohrung Coolant for through hole
	Axialstechen vor der Mitte innen Internal face grooving in front of center		Zwischenbüchse mit verstärktem Bund Intermediate sleeve with reinforced collar
	Axialstechen mit Bund Axial grooving with collar		axiale Längenverstellung axial length adjustment
	Zähnezahlen Numbers of teeth		Rundlauf einstellbar Adjustable run-out
	Geometrie H Geometry H		axialer Pendelausgleich axial pendulum element
	nicht warmschrumpfen do not shrink		Einstellbar Adjustable

Übersicht Anwendungen

Overview Application



	Urma		HSK-A Schaffformen DIN ISO 12164-1 A, C Shank forms
	Beta-Modul		SK-AB Schaffform DIN ISO 7388-1 AD/AF Shank form
	Intramax K		JIS-BT Schaffform JIS B 6339 Shank form
	Intramax G		PSC Schaffform ISO 26623-1 Shank form
	Verzahnung gerade Straight fluted		Cermet Cermet
	Verzahnung linksschräg Left helical fluted		nicht unterbrochener Schnitt non-interrupted cut
	Digital		Schräger Bohrungsein-, austritt Drilling inclined entry and exit
	Bohrung Datenträger DIN69973 Bore hole for data carrier		Anbohren auf Konkaver Fläche Drilling on concave surface
	Verstellbereich metrisch Adjustment range metric		Sackloch Blind hole
	maximale Drehzahl Number of revolutions maximum		Durchgangsbohrung Through hole
	analog		Paketbohren Package drilling
	Rundlauf über VDR Run-out over VDR		Querbohrung Cross drilling
	Bohren DIN 6537 K, L Boring		Schneidenwinkel Cutting angle
	Schaffformen HA, A, B, E Shank forms		Schneidenwinkel Cutting angle

- Alle Abmessungen sind in mm angegeben, sofern nicht anders vermerkt.
All dimensions in mm, unless otherwise noted
- Weitere Abmessungen und Ausführungen sind auf Anfrage erhältlich.
Further dimensions and versions are available on request.
- Das Anzugsmoment der Schrauben finden Sie im Kapitel "Technische Hinweise".
For torque specification of the screw, please see "Technical Instructions".
- Alle Klemmhalter können von unserem Reparaturservice instand gesetzt werden.
All toolholders with damaged seating can be repaired by HORN.
- Lieferzeiten / delivery times
 - ▲ ab Lager / on stock
 - Δ 4 Wochen / 4 weeks
- Einsatz für Werkstoffgruppen / Use for material groups
 - empfohlen / recommended
 - bedingt einsetzbar / alternative recommended
 - nicht geeignet / not suitable

Die HORN-Trennstellencodierung - wofür wird sie benötigt?

Die Trennstellencodierung stellt sicher, dass Sie immer die zueinander passenden Werkzeuge finden und wird bei Werkzeughaltern und bei Schneidplatten ausgewiesen. Wenn die Codes übereinstimmen, kann die Schneidplatte im entsprechenden Werkzeughalter verwendet werden. Das gilt auch für unser modulares Haltersystem, hier gibt die Trennstellencodierung die Schnittstelle zwischen Grundhalter und Kassette an.

The HORN connection interface code - what is it needed for?

The connection interface code ensures that you will always find the appropriate tools and is shown on toolholders and inserts. If the codes match, the insert can be used in the corresponding toolholder. This also applies to our modular holder system, where the connection code indicates the interface between the holder and the cassette.

HORN-Trennstellencodes und mögliche Kombinationen:

HORN connection interface codes and possible combinations:

- HIS** = Plattensitzgröße / Insert seat
HWS = Trennstelle Werkstückseitig / Interface workpiece side
HMS = Trennstelle Maschinenseitig / Interface machine side

HIS	↔	HWS
HMS	↔	HWS

Beispiel Schneidplatte

Example insert

Bestellnummer Part number	r	f	a	d	b	l ₂	l ₅	t _{max}	Ds	HIS	EG35
R105.BO.30.20.045.2	0,2	1,5	2,7	2,4	7	4,5	31	0,1	3	105125	▲

Beispiel Klemmhalter

Example toolholder

Bestellnummer Part number	d	l ₁	h	l ₄	l ₅	HWS
B105.0022.1.2.01	22	120	20	72	5	105123 • 105124 • 105125



**für Anwendungen in Stahl
und nichtrostendem Stahl**

**for steel and stainless
steeldrilling applications**

Vollhartmetall-Bohrer
Solid carbide drilling tools
D1122/DDM

3xd

Seite/Page
11-15, 26-31

5xd

Seite/Page
16-20, 32-37

8xd

Seite/Page
21-25

Bezeichnungsschlüssel
Identification Key

Seite/Page
38-39

Schnittdaten
Cutting data

Seite/Page
40-45

Vollhartmetall-Bohrer

Solid carbide drilling tools

D1122



A

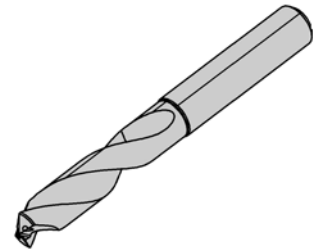
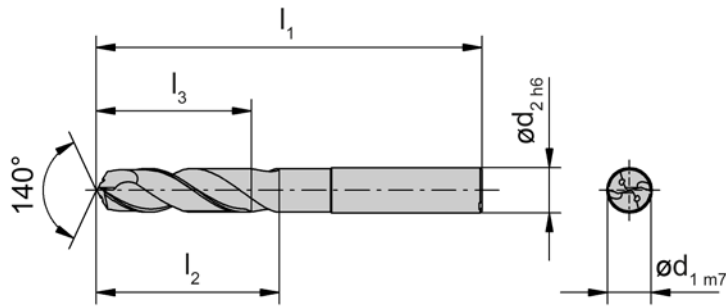
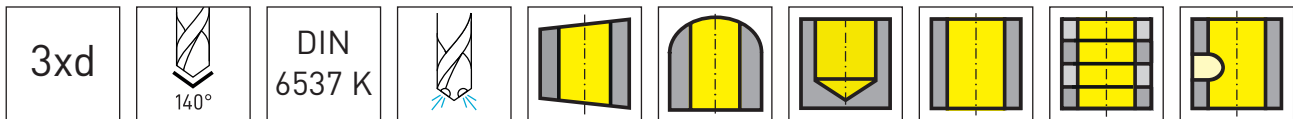

HM-Sorten
Carbide grades

▲ ab Lager
on stock

△ 4 Wochen
4 weeks

Bestellnummer Part number	d _{1m7}	d _{2h6}	l ₁	l ₂	l ₃	Form	ES35
D1122.03.A0300C	3	6	62	20	14	DIN 6335 HA	▲
D1122.03.A0310C	3,1	6	62	20	14	DIN 6335 HA	△
D1122.03.A0320C	3,2	6	62	20	14	DIN 6335 HA	△
D1122.03.A0330C	3,3	6	62	20	14	DIN 6335 HA	▲
D1122.03.A0340C	3,4	6	62	20	14	DIN 6335 HA	△
D1122.03.A0350C	3,5	6	62	20	14	DIN 6335 HA	▲
D1122.03.A0360C	3,6	6	62	20	14	DIN 6335 HA	△
D1122.03.A0370C	3,7	6	62	20	14	DIN 6335 HA	△
D1122.03.A0380C	3,8	6	66	24	17	DIN 6335 HA	▲
D1122.03.A0390C	3,9	6	66	24	17	DIN 6335 HA	△
D1122.03.A0400C	4	6	66	24	17	DIN 6335 HA	▲
D1122.03.A0410C	4,1	6	66	24	17	DIN 6335 HA	△
D1122.03.A0420C	4,2	6	66	24	17	DIN 6335 HA	▲
D1122.03.A0430C	4,3	6	66	24	17	DIN 6335 HA	△
D1122.03.A0440C	4,4	6	66	24	17	DIN 6335 HA	△
D1122.03.A0450C	4,5	6	66	24	17	DIN 6335 HA	▲
D1122.03.A0460C	4,6	6	66	24	17	DIN 6335 HA	△
D1122.03.A0470C	4,7	6	66	24	17	DIN 6335 HA	△
D1122.03.A0480C	4,8	6	66	28	20	DIN 6335 HA	▲
D1122.03.A0490C	4,9	6	66	28	20	DIN 6335 HA	△
D1122.03.A0500C	5	6	66	28	20	DIN 6335 HA	▲
D1122.03.A0510C	5,1	6	66	28	20	DIN 6335 HA	△
D1122.03.A0520C	5,2	6	66	28	20	DIN 6335 HA	△
D1122.03.A0530C	5,3	6	66	28	20	DIN 6335 HA	△

P	●
M	-
K	●
N	-
S	-
H	-

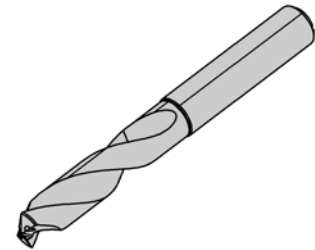
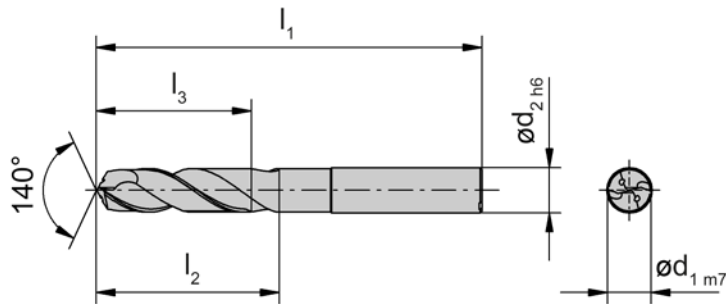
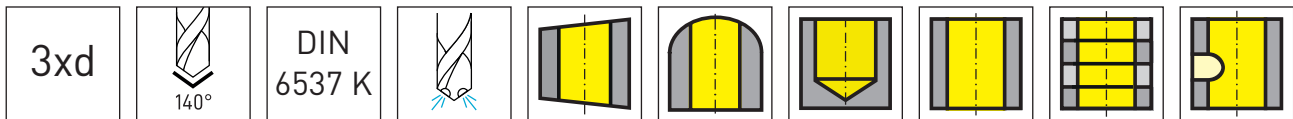

HM-Sorten
Carbide grades

▲ ab Lager
on stock

△ 4 Wochen
4 weeks

Bestellnummer Part number	d _{1m7}	d _{2h6}	l ₁	l ₂	l ₃	Form	ES35
D1122.03.A0540C	5,4	6	66	28	20	DIN 6335 HA	△
D1122.03.A0550C	5,5	6	66	28	20	DIN 6335 HA	▲
D1122.03.A0560C	5,6	6	66	28	20	DIN 6335 HA	△
D1122.03.A0570C	5,7	6	66	28	20	DIN 6335 HA	△
D1122.03.A0580C	5,8	6	66	28	20	DIN 6335 HA	▲
D1122.03.A0590C	5,9	6	66	28	20	DIN 6335 HA	△
D1122.03.A0600C	6	6	66	28	20	DIN 6335 HA	▲
D1122.03.A0610C	6,1	8	79	34	24	DIN 6335 HA	△
D1122.03.A0620C	6,2	8	79	34	24	DIN 6335 HA	△
D1122.03.A0630C	6,3	8	79	34	24	DIN 6335 HA	△
D1122.03.A0640C	6,4	8	79	34	24	DIN 6335 HA	△
D1122.03.A0650C	6,5	8	79	34	24	DIN 6335 HA	▲
D1122.03.A0660C	6,6	8	79	34	24	DIN 6335 HA	△
D1122.03.A0670C	6,7	8	79	34	24	DIN 6335 HA	△
D1122.03.A0680C	6,8	8	79	34	24	DIN 6335 HA	▲
D1122.03.A0690C	6,9	8	79	34	24	DIN 6335 HA	△
D1122.03.A0700C	7	8	79	34	24	DIN 6335 HA	▲
D1122.03.A0710C	7,1	8	79	41	29	DIN 6335 HA	△
D1122.03.A0720C	7,2	8	79	41	29	DIN 6335 HA	△
D1122.03.A0730C	7,3	8	79	41	29	DIN 6335 HA	△
D1122.03.A0740C	7,4	8	79	41	29	DIN 6335 HA	△
D1122.03.A0750C	7,5	8	79	41	29	DIN 6335 HA	▲
D1122.03.A0760C	7,6	8	79	41	29	DIN 6335 HA	△
D1122.03.A0770C	7,7	8	79	41	29	DIN 6335 HA	△
D1122.03.A0780C	7,8	8	79	41	29	DIN 6335 HA	▲
D1122.03.A0790C	7,9	8	79	41	29	DIN 6335 HA	△

P	●
M	-
K	●
N	-
S	-
H	-

Vollhartmetall-Bohrer

Solid carbide drilling tools

D1122



A

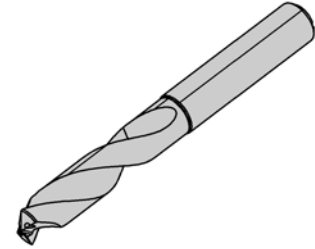
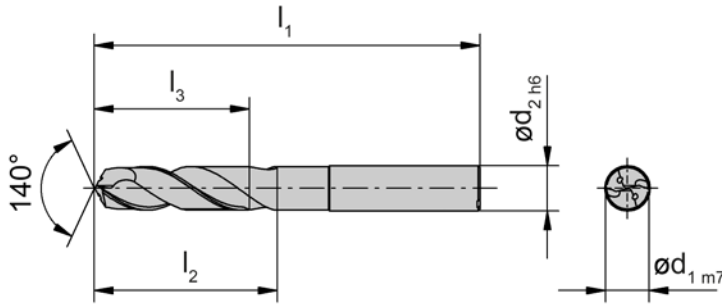
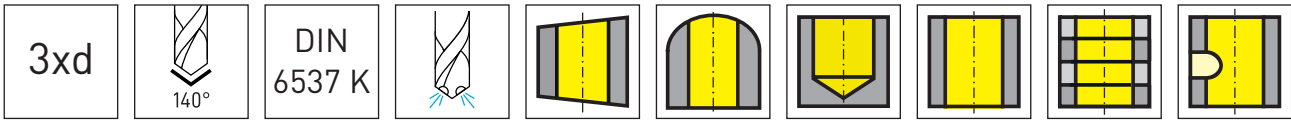

HM-Sorten
Carbide grades

▲ ab Lager
on stock

△ 4 Wochen
4 weeks

Bestellnummer Part number	d _{1m7}	d _{2h6}	l ₁	l ₂	l ₃	Form	ES35
D1122.03.A0800C	8	8	79	41	29	DIN 6335 HA	▲
D1122.03.A0810C	8,1	10	89	47	35	DIN 6335 HA	△
D1122.03.A0820C	8,2	10	89	47	35	DIN 6335 HA	△
D1122.03.A0830C	8,3	10	89	47	35	DIN 6335 HA	△
D1122.03.A0840C	8,4	10	89	47	35	DIN 6335 HA	△
D1122.03.A0850C	8,5	10	89	47	35	DIN 6335 HA	▲
D1122.03.A0860C	8,6	10	89	47	35	DIN 6335 HA	△
D1122.03.A0870C	8,7	10	89	47	35	DIN 6335 HA	△
D1122.03.A0880C	8,8	10	89	47	35	DIN 6335 HA	▲
D1122.03.A0890C	8,9	10	89	47	35	DIN 6335 HA	△
D1122.03.A0900C	9	10	89	47	35	DIN 6335 HA	▲
D1122.03.A0910C	9,1	10	89	47	35	DIN 6335 HA	△
D1122.03.A0920C	9,2	10	89	47	35	DIN 6335 HA	△
D1122.03.A0930C	9,3	10	89	47	35	DIN 6335 HA	△
D1122.03.A0940C	9,4	10	89	47	35	DIN 6335 HA	△
D1122.03.A0950C	9,5	10	89	47	35	DIN 6335 HA	▲
D1122.03.A0960C	9,6	10	89	47	35	DIN 6335 HA	△
D1122.03.A0970C	9,7	10	89	47	35	DIN 6335 HA	△
D1122.03.A0980C	9,8	10	89	47	35	DIN 6335 HA	▲
D1122.03.A0990C	9,9	10	89	47	35	DIN 6335 HA	△
D1122.03.A1000C	10	10	89	47	35	DIN 6335 HA	▲
D1122.03.A1010C	10,1	12	102	55	40	DIN 6335 HA	△
D1122.03.A1020C	10,2	12	102	55	40	DIN 6335 HA	▲
D1122.03.A1030C	10,3	12	102	55	40	DIN 6335 HA	△
D1122.03.A1040C	10,4	12	102	55	40	DIN 6335 HA	△

P	●
M	-
K	●
N	-
S	-
H	-

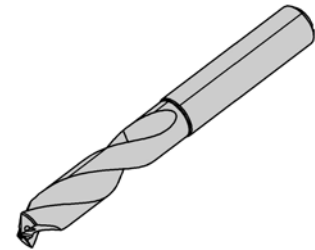
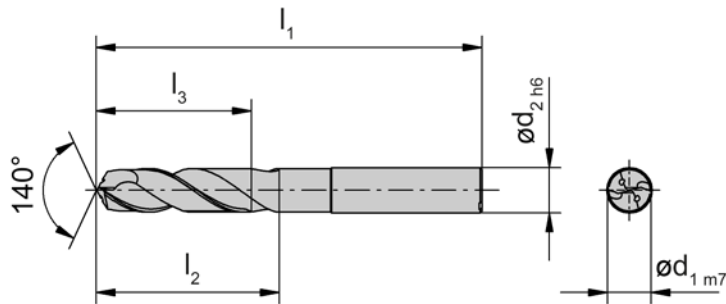
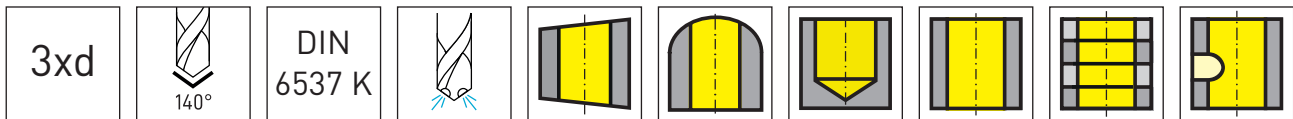

HM-Sorten
Carbide grades

▲ ab Lager
on stock

△ 4 Wochen
4 weeks

Bestellnummer Part number	d _{1m7}	d _{2h6}	l ₁	l ₂	l ₃	Form	ES35
D1122.03.A1050C	10,5	12	102	55	40	DIN 6335 HA	▲
D1122.03.A1060C	10,6	12	102	55	40	DIN 6335 HA	△
D1122.03.A1070C	10,7	12	102	55	40	DIN 6335 HA	△
D1122.03.A1080C	10,8	12	102	55	40	DIN 6335 HA	▲
D1122.03.A1090C	10,9	12	102	55	40	DIN 6335 HA	△
D1122.03.A1100C	11	12	102	55	40	DIN 6335 HA	▲
D1122.03.A1110C	11,1	12	102	55	40	DIN 6335 HA	△
D1122.03.A1120C	11,2	12	102	55	40	DIN 6335 HA	△
D1122.03.A1130C	11,3	12	102	55	40	DIN 6335 HA	△
D1122.03.A1140C	11,4	12	102	55	40	DIN 6335 HA	△
D1122.03.A1150C	11,5	12	102	55	40	DIN 6335 HA	▲
D1122.03.A1160C	11,6	12	102	55	40	DIN 6335 HA	△
D1122.03.A1170C	11,7	12	102	55	40	DIN 6335 HA	△
D1122.03.A1180C	11,8	12	102	55	40	DIN 6335 HA	▲
D1122.03.A1190C	11,9	12	102	55	40	DIN 6335 HA	△
D1122.03.A1200C	12	12	102	55	40	DIN 6335 HA	▲
D1122.03.A1210C	12,1	14	107	60	43	DIN 6335 HA	△
D1122.03.A1220C	12,2	14	107	60	43	DIN 6335 HA	△
D1122.03.A1230C	12,3	14	107	60	43	DIN 6335 HA	△
D1122.03.A1240C	12,4	14	107	60	43	DIN 6335 HA	△
D1122.03.A1250C	12,5	14	107	60	43	DIN 6335 HA	▲
D1122.03.A1260C	12,6	14	107	60	43	DIN 6335 HA	△
D1122.03.A1270C	12,7	14	107	60	43	DIN 6335 HA	△
D1122.03.A1280C	12,8	14	107	60	43	DIN 6335 HA	▲
D1122.03.A1290C	12,9	14	107	60	43	DIN 6335 HA	△

P	●
M	-
K	●
N	-
S	-
H	-

Vollhartmetall-Bohrer

Solid carbide drilling tools

D1122



A

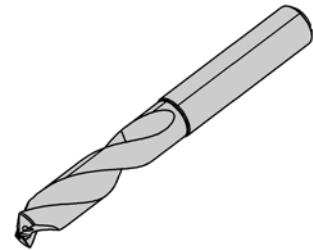
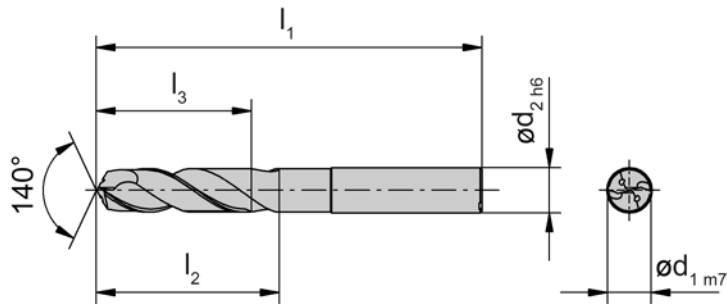
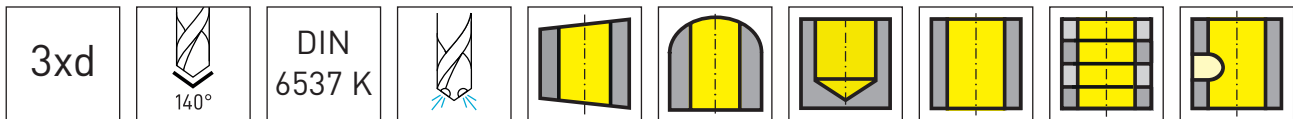

HM-Sorten
Carbide grades

▲ ab Lager
on stock

△ 4 Wochen
4 weeks

Bestellnummer Part number	d _{1m7}	d _{2h6}	l ₁	l ₂	l ₃	Form	ES35
D1122.03.A1300C	13	14	107	60	43	DIN 6335 HA	▲
D1122.03.A1350C	13,5	14	107	60	43	DIN 6335 HA	▲
D1122.03.A1380C	13,8	14	107	60	43	DIN 6335 HA	▲
D1122.03.A1400C	14	14	107	60	43	DIN 6335 HA	▲
D1122.03.A1450C	14,5	16	115	65	45	DIN 6335 HA	▲
D1122.03.A1480C	14,8	16	115	65	45	DIN 6335 HA	▲
D1122.03.A1500C	15	16	115	65	45	DIN 6335 HA	▲
D1122.03.A1550C	15,5	16	115	65	45	DIN 6335 HA	▲
D1122.03.A1580C	15,8	16	115	65	45	DIN 6335 HA	▲
D1122.03.A1600C	16	16	115	65	45	DIN 6335 HA	▲
D1122.03.A1650C	16,5	18	123	73	51	DIN 6335 HA	▲
D1122.03.A1680C	16,8	18	123	73	51	DIN 6335 HA	▲
D1122.03.A1700C	17	18	123	73	51	DIN 6335 HA	▲
D1122.03.A1750C	17,5	18	123	73	51	DIN 6335 HA	▲
D1122.03.A1780C	17,8	18	123	73	51	DIN 6335 HA	▲
D1122.03.A1800C	18	18	123	73	51	DIN 6335 HA	▲
D1122.03.A1850C	18,5	20	131	79	55	DIN 6335 HA	▲
D1122.03.A1880C	18,8	20	131	79	55	DIN 6335 HA	▲
D1122.03.A1900C	19	20	131	79	55	DIN 6335 HA	▲
D1122.03.A1950C	19,5	20	131	79	55	DIN 6335 HA	▲
D1122.03.A1980C	19,8	20	131	79	55	DIN 6335 HA	▲
D1122.03.A2000C	20	20	131	79	55	DIN 6335 HA	▲

P	●
M	-
K	●
N	-
S	-
H	-

Vollhartmetall-Bohrer D1122

Solid carbide drilling tools

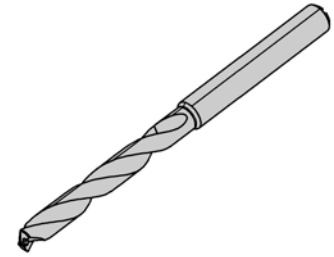
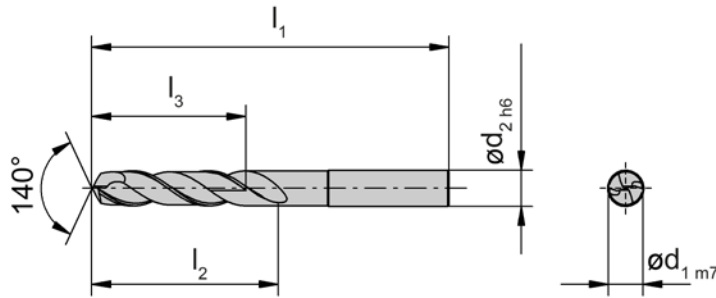
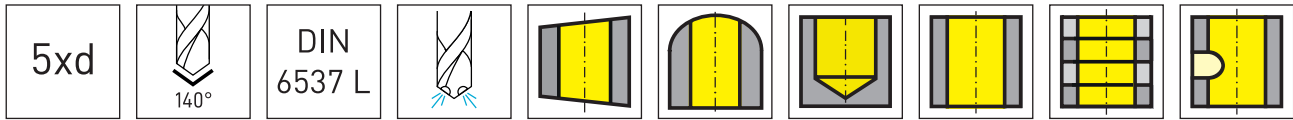

HM-Sorten
Carbide grades

▲ ab Lager
on stock

△ 4 Wochen
4 weeks

Bestellnummer Part number	d ₁	d ₂	l ₁	l ₂	l ₃	Form	ES35
D1122.05.A0300C	3	6	66	28	23	DIN 6335 HA	▲
D1122.05.A0310C	3,1	6	66	28	23	DIN 6335 HA	△
D1122.05.A0320C	3,2	6	66	28	23	DIN 6335 HA	△
D1122.05.A0330C	3,3	6	66	28	23	DIN 6335 HA	▲
D1122.05.A0340C	3,4	6	66	28	23	DIN 6335 HA	△
D1122.05.A0350C	3,5	6	66	28	23	DIN 6335 HA	▲
D1122.05.A0360C	3,6	6	66	28	23	DIN 6335 HA	△
D1122.05.A0370C	3,7	6	66	28	23	DIN 6335 HA	△
D1122.05.A0380C	3,8	6	74	36	29	DIN 6335 HA	▲
D1122.05.A0390C	3,9	6	74	36	29	DIN 6335 HA	△
D1122.05.A0400C	4	6	74	36	29	DIN 6335 HA	▲
D1122.05.A0410C	4,1	6	74	36	29	DIN 6335 HA	△
D1122.05.A0420C	4,2	6	74	36	29	DIN 6335 HA	▲
D1122.05.A0430C	4,3	6	74	36	29	DIN 6335 HA	△
D1122.05.A0440C	4,4	6	74	36	29	DIN 6335 HA	△
D1122.05.A0450C	4,5	6	74	36	29	DIN 6335 HA	▲
D1122.05.A0460C	4,6	6	74	36	29	DIN 6335 HA	△
D1122.05.A0470C	4,7	6	74	36	29	DIN 6335 HA	△
D1122.05.A0480C	4,8	6	82	44	35	DIN 6335 HA	▲
D1122.05.A0490C	4,9	6	82	44	35	DIN 6335 HA	△
D1122.05.A0500C	5	6	82	44	35	DIN 6335 HA	▲
D1122.05.A0510C	5,4	6	82	44	35	DIN 6335 HA	▲
D1122.05.A0520C	5,2	6	82	44	35	DIN 6335 HA	△
D1122.05.A0530C	5,3	6	82	44	35	DIN 6335 HA	△

P	●
M	-
K	●
N	-
S	-
H	-

Vollhartmetall-Bohrer

Solid carbide drilling tools

D1122



A

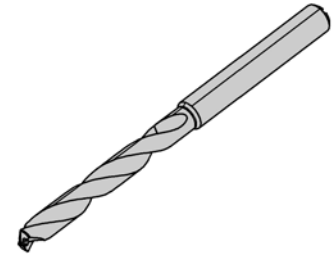
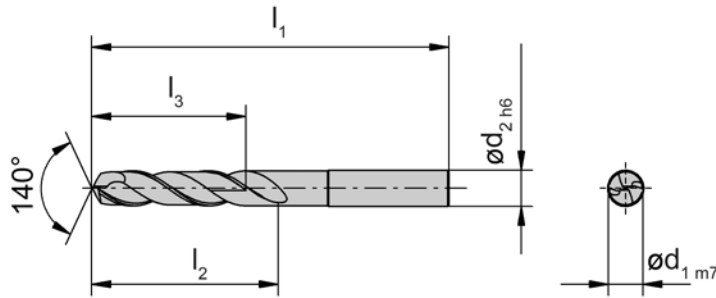
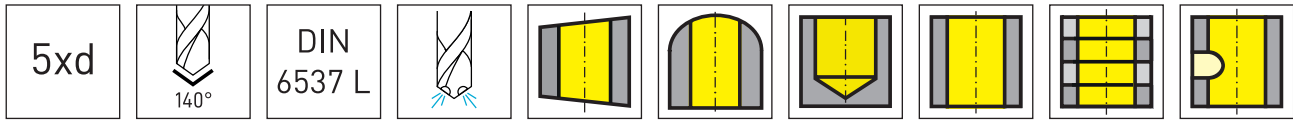

HM-Sorten
Carbide grades

▲ ab Lager
on stock

△ 4 Wochen
4 weeks

Bestellnummer Part number	d ₁	d ₂	l ₁	l ₂	l ₃	Form	ES35
D1122.05.A0540C	5,4	6	82	44	35	DIN 6335 HA	△
D1122.05.A0550C	5,5	6	82	44	35	DIN 6335 HA	▲
D1122.05.A0560C	5,6	6	82	44	35	DIN 6335 HA	△
D1122.05.A0570C	5,7	6	82	44	35	DIN 6335 HA	△
D1122.05.A0580C	5,8	6	82	44	35	DIN 6335 HA	▲
D1122.05.A0590C	5,9	6	82	44	35	DIN 6335 HA	△
D1122.05.A0600C	6	6	82	44	35	DIN 6335 HA	▲
D1122.05.A0610C	6,1	8	91	53	43	DIN 6335 HA	▲
D1122.05.A0620C	6,2	8	91	53	43	DIN 6335 HA	△
D1122.05.A0630C	6,3	8	91	53	43	DIN 6335 HA	△
D1122.05.A0640C	6,4	8	91	53	43	DIN 6335 HA	△
D1122.05.A0650C	6,5	8	91	53	43	DIN 6335 HA	▲
D1122.05.A0660C	6,6	8	91	53	43	DIN 6335 HA	△
D1122.05.A0670C	6,7	8	91	53	43	DIN 6335 HA	△
D1122.05.A0680C	6,8	8	91	53	43	DIN 6335 HA	▲
D1122.05.A0690C	6,9	8	91	53	43	DIN 6335 HA	△
D1122.05.A0700C	7	8	91	53	43	DIN 6335 HA	▲
D1122.05.A0710C	7,1	8	91	53	43	DIN 6335 HA	△
D1122.05.A0720C	7,2	8	91	53	43	DIN 6335 HA	△
D1122.05.A0730C	7,3	8	91	53	43	DIN 6335 HA	△
D1122.05.A0740C	7,4	8	91	53	43	DIN 6335 HA	△
D1122.05.A0750C	7,5	8	91	53	43	DIN 6335 HA	▲
D1122.05.A0760C	7,6	8	91	53	43	DIN 6335 HA	△
D1122.05.A0770C	7,7	8	91	53	43	DIN 6335 HA	△
D1122.05.A0780C	7,8	8	91	53	43	DIN 6335 HA	▲
D1122.05.A0790C	7,9	8	91	53	43	DIN 6335 HA	△

P	●
M	-
K	●
N	-
S	-
H	-

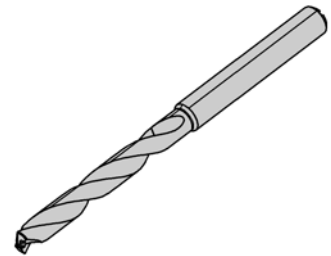
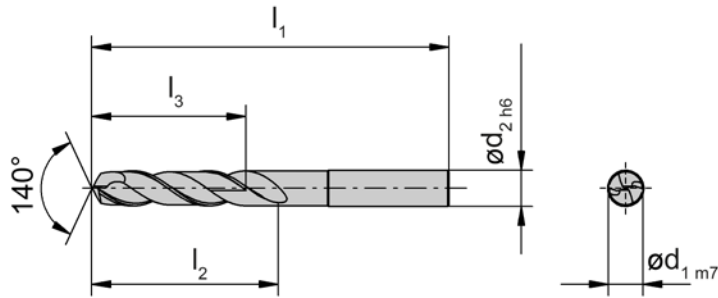
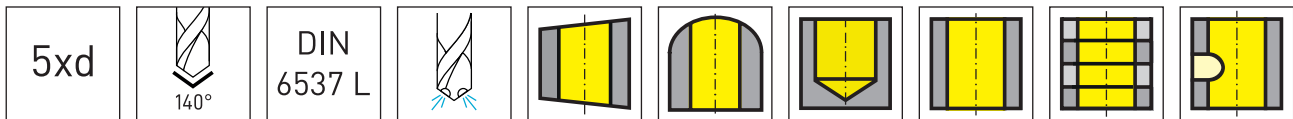

HM-Sorten
Carbide grades

▲ ab Lager
on stock

△ 4 Wochen
4 weeks

Bestellnummer Part number	d ₁	d ₂	l ₁	l ₂	l ₃	Form	ES35
D1122.05.A0800C	8	8	91	53	43	DIN 6335 HA	▲
D1122.05.A0810C	8,1	10	103	61	49	DIN 6335 HA	△
D1122.05.A0820C	8,2	10	103	61	49	DIN 6335 HA	△
D1122.05.A0830C	8,3	10	103	61	49	DIN 6335 HA	△
D1122.05.A0840C	8,4	10	103	61	49	DIN 6335 HA	△
D1122.05.A0850C	8,5	10	103	61	49	DIN 6335 HA	▲
D1122.05.A0860C	8,6	10	103	61	49	DIN 6335 HA	△
D1122.05.A0870C	8,7	10	103	61	49	DIN 6335 HA	△
D1122.05.A0880C	8,8	10	103	61	49	DIN 6335 HA	▲
D1122.05.A0890C	8,9	10	103	61	49	DIN 6335 HA	△
D1122.05.A0900C	9	10	103	61	49	DIN 6335 HA	▲
D1122.05.A0910C	9,1	10	103	61	49	DIN 6335 HA	△
D1122.05.A0920C	9,2	10	103	61	49	DIN 6335 HA	△
D1122.05.A0930C	9,3	10	103	61	49	DIN 6335 HA	△
D1122.05.A0940C	9,4	10	103	61	49	DIN 6335 HA	△
D1122.05.A0950C	9,5	10	103	61	49	DIN 6335 HA	▲
D1122.05.A0960C	9,6	10	103	61	49	DIN 6335 HA	△
D1122.05.A0970C	9,7	10	103	61	49	DIN 6335 HA	△
D1122.05.A0980C	9,8	10	103	61	49	DIN 6335 HA	▲
D1122.05.A0990C	9,9	10	103	61	49	DIN 6335 HA	△
D1122.05.A1000C	10	10	103	61	49	DIN 6335 HA	▲
D1122.05.A1010C	10,1	12	118	71	56	DIN 6335 HA	△
D1122.05.A1020C	10,2	12	118	71	56	DIN 6335 HA	▲
D1122.05.A1030C	10,3	12	118	71	56	DIN 6335 HA	△
D1122.05.A1040C	10,4	12	118	71	56	DIN 6335 HA	△
D1122.05.A1050C	10,5	12	118	71	56	DIN 6335 HA	▲

P	●
M	-
K	●
N	-
S	-
H	-

Vollhartmetall-Bohrer

Solid carbide drilling tools

D1122



A

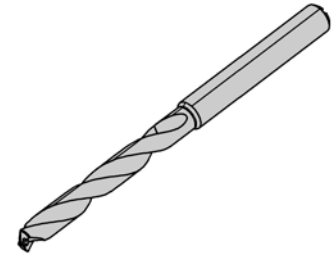
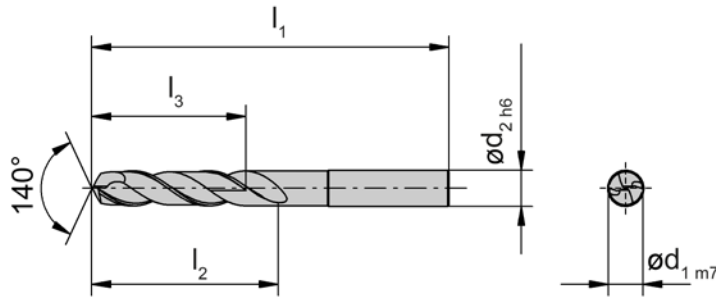
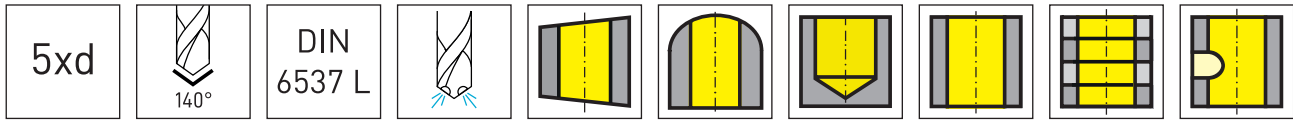

HM-Sorten
Carbide grades

▲ ab Lager
on stock

△ 4 Wochen
4 weeks

Bestellnummer Part number	d ₁	d ₂	l ₁	l ₂	l ₃	Form	ES35
D1122.05.A1060C	10,6	12	118	71	56	DIN 6335 HA	△
D1122.05.A1070C	10,7	12	118	71	56	DIN 6335 HA	△
D1122.05.A1080C	10,8	12	118	71	56	DIN 6335 HA	▲
D1122.05.A1090C	10,9	12	118	71	56	DIN 6335 HA	△
D1122.05.A1100C	11	12	118	71	56	DIN 6335 HA	▲
D1122.05.A1110C	11,1	12	118	71	56	DIN 6335 HA	△
D1122.05.A1120C	11,2	12	118	71	56	DIN 6335 HA	△
D1122.05.A1130C	11,3	12	118	71	56	DIN 6335 HA	△
D1122.05.A1140C	11,4	12	118	71	56	DIN 6335 HA	△
D1122.05.A1150C	11,5	12	118	71	56	DIN 6335 HA	▲
D1122.05.A1160C	11,6	12	118	71	56	DIN 6335 HA	△
D1122.05.A1170C	11,7	12	118	71	56	DIN 6335 HA	△
D1122.05.A1180C	11,8	12	118	71	56	DIN 6335 HA	▲
D1122.05.A1190C	11,9	12	118	71	56	DIN 6335 HA	△
D1122.05.A1200C	12	12	118	71	56	DIN 6335 HA	▲
D1122.05.A1210C	12,1	14	124	77	60	DIN 6335 HA	△
D1122.05.A1220C	12,2	14	124	77	60	DIN 6335 HA	△
D1122.05.A1230C	12,3	14	124	77	60	DIN 6335 HA	△
D1122.05.A1240C	12,4	14	124	77	60	DIN 6335 HA	△
D1122.05.A1250C	12,5	14	124	77	60	DIN 6335 HA	▲
D1122.05.A1260C	12,6	14	124	77	60	DIN 6335 HA	△
D1122.05.A1270C	12,7	14	124	77	60	DIN 6335 HA	△
D1122.05.A1280C	12,8	14	124	77	60	DIN 6335 HA	▲
D1122.05.A1290C	12,9	14	124	77	60	DIN 6335 HA	△

P	●
M	-
K	●
N	-
S	-
H	-

Vollhartmetall-Bohrer

Solid carbide drilling tools

D1122

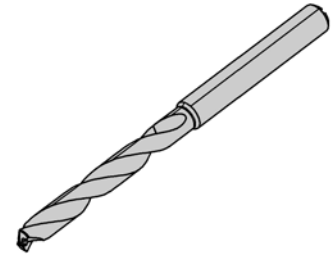
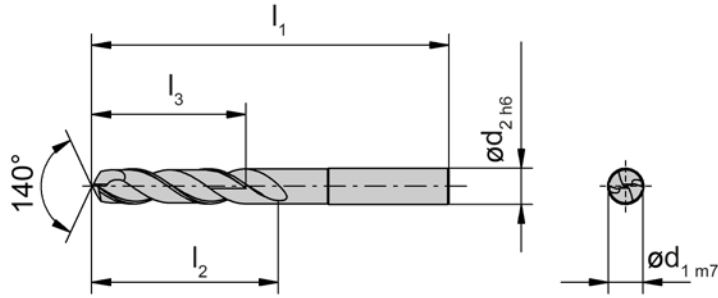
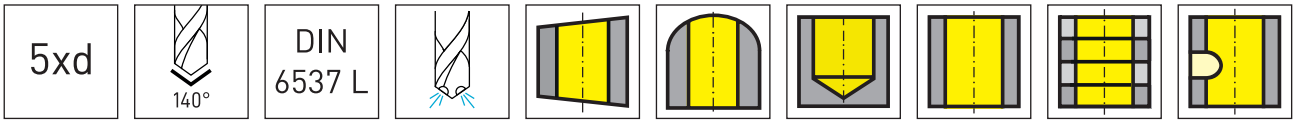

HM-Sorten
Carbide grades

▲ ab Lager
on stock

△ 4 Wochen
4 weeks

Bestellnummer Part number	d ₁	d ₂	l ₁	l ₂	l ₃	Form	ES35
D1122.05.A1300C	13	14	124	77	60	DIN 6335 HA	▲
D1122.05.A1350C	13,5	14	124	77	60	DIN 6335 HA	▲
D1122.05.A1380C	13,8	14	124	77	60	DIN 6335 HA	▲
D1122.05.A1400C	14	14	124	77	60	DIN 6335 HA	▲
D1122.05.A1450C	14,5	16	133	83	63	DIN 6335 HA	▲
D1122.05.A1480C	14,8	16	133	83	63	DIN 6335 HA	▲
D1122.05.A1500C	15	16	133	83	63	DIN 6335 HA	▲
D1122.05.A1550C	15,5	16	133	83	63	DIN 6335 HA	▲
D1122.05.A1580C	15,8	16	133	83	63	DIN 6335 HA	▲
D1122.05.A1600C	16	16	133	83	63	DIN 6335 HA	▲
D1122.05.A1650C	16,5	18	143	93	71	DIN 6335 HA	▲
D1122.05.A1680C	16,8	18	143	93	71	DIN 6335 HA	▲
D1122.05.A1700C	17	18	143	93	71	DIN 6335 HA	▲
D1122.05.A1750C	17,5	18	143	93	71	DIN 6335 HA	▲
D1122.05.A1780C	17,8	18	143	93	71	DIN 6335 HA	▲
D1122.05.A1800C	18	18	143	93	71	DIN 6335 HA	▲
D1122.05.A1850C	18,5	20	153	101	77	DIN 6335 HA	▲
D1122.05.A1880C	18,8	20	153	101	77	DIN 6335 HA	▲
D1122.05.A1900C	19	20	153	101	77	DIN 6335 HA	▲
D1122.05.A1950C	19,5	20	153	101	77	DIN 6335 HA	▲
D1122.05.A1980C	19,8	20	153	101	77	DIN 6335 HA	▲
D1122.05.A2000C	20	20	153	101	77	DIN 6335 HA	▲

P	●
M	-
K	●
N	-
S	-
H	-

Vollhartmetall-Bohrer

Solid carbide drilling tools

D1122



A

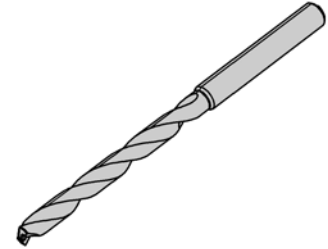
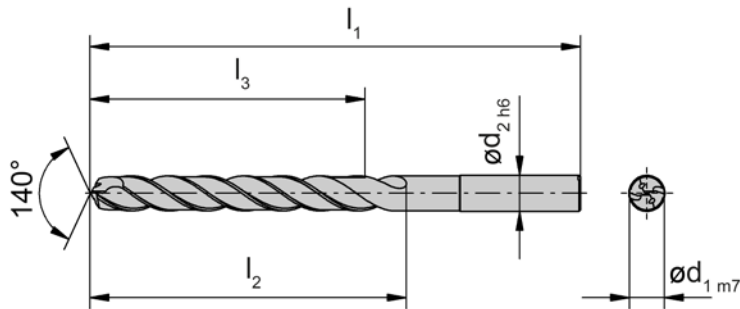
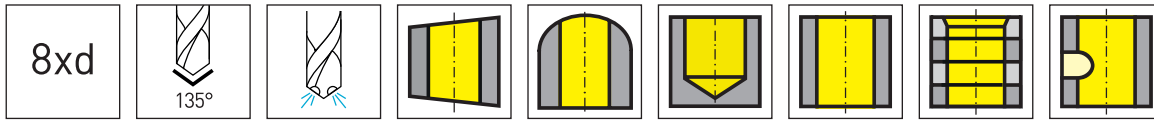

HM-Sorten
Carbide grades

▲ ab Lager
on stock

△ 4 Wochen
4 weeks

Bestellnummer Part number	d ₁	d ₂	l ₁	l ₂	l ₃	Form	ES35
D1122.08.A0300C	3	6	72	34	29	DIN 6335 HA	▲
D1122.08.A0310C	3,1	6	72	34	29	DIN 6335 HA	△
D1122.08.A0320C	3,2	6	72	34	29	DIN 6335 HA	△
D1122.08.A0330C	3,3	6	72	34	29	DIN 6335 HA	▲
D1122.08.A0340C	3,4	6	72	34	29	DIN 6335 HA	△
D1122.08.A0350C	3,5	6	72	34	29	DIN 6335 HA	▲
D1122.08.A0360C	3,6	6	72	34	29	DIN 6335 HA	△
D1122.08.A0370C	3,7	6	72	34	29	DIN 6335 HA	△
D1122.08.A0380C	3,8	6	81	43	36	DIN 6335 HA	▲
D1122.08.A0390C	3,9	6	81	43	36	DIN 6335 HA	△
D1122.08.A0400C	4	6	81	43	36	DIN 6335 HA	▲
D1122.08.A0410C	4,1	6	81	43	36	DIN 6335 HA	△
D1122.08.A0420C	4,2	6	81	43	36	DIN 6335 HA	▲
D1122.08.A0430C	4,3	6	81	43	36	DIN 6335 HA	△
D1122.08.A0440C	4,4	6	81	43	36	DIN 6335 HA	△
D1122.08.A0450C	4,5	6	81	43	36	DIN 6335 HA	▲
D1122.08.A0460C	4,6	6	81	43	36	DIN 6335 HA	△
D1122.08.A0470C	4,7	6	81	43	36	DIN 6335 HA	▲
D1122.08.A0480C	4,8	6	95	57	48	DIN 6335 HA	▲
D1122.08.A0490C	4,9	6	95	57	48	DIN 6335 HA	▲
D1122.08.A0500C	5	6	95	57	48	DIN 6335 HA	▲
D1122.08.A0510C	5,1	6	95	57	48	DIN 6335 HA	△
D1122.08.A0520C	5,2	6	95	57	48	DIN 6335 HA	△
D1122.08.A0530C	5,3	6	95	57	48	DIN 6335 HA	△

P	●
M	-
K	●
N	-
S	-
H	-

Vollhartmetall-Bohrer D1122

Solid carbide drilling tools

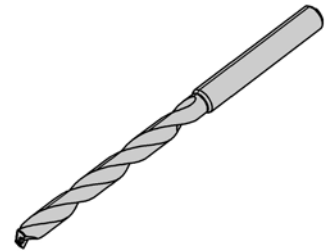
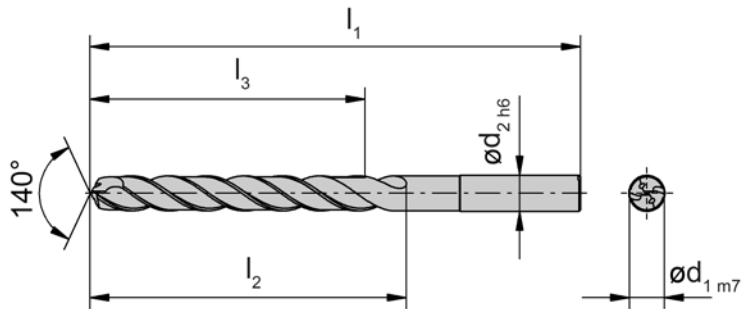
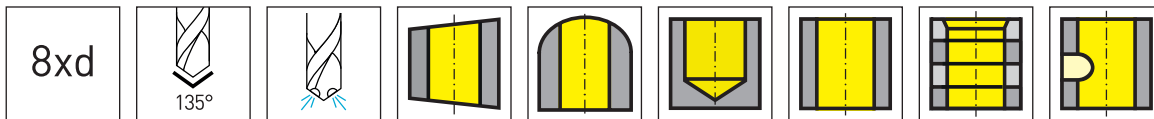

HM-Sorten
Carbide grades

▲ ab Lager
on stock

△ 4 Wochen
4 weeks

Bestellnummer Part number	d ₁	d ₂	l ₁	l ₂	l ₃	Form	ES35
D1122.08.A0540C	5,4	6	95	57	48	DIN 6335 HA	△
D1122.08.A0550C	5,5	6	95	57	48	DIN 6335 HA	▲
D1122.08.A0560C	5,6	6	95	57	48	DIN 6335 HA	△
D1122.08.A0570C	5,7	6	95	57	48	DIN 6335 HA	△
D1122.08.A0580C	5,8	6	95	57	48	DIN 6335 HA	▲
D1122.08.A0590C	5,9	6	95	57	48	DIN 6335 HA	△
D1122.08.A0600C	6	6	95	57	48	DIN 6335 HA	▲
D1122.08.A0610C	6,1	8	114	76	64	DIN 6335 HA	△
D1122.08.A0620C	6,2	8	114	76	64	DIN 6335 HA	△
D1122.08.A0630C	6,3	8	114	76	64	DIN 6335 HA	△
D1122.08.A0640C	6,4	8	114	76	64	DIN 6335 HA	△
D1122.08.A0650C	6,5	8	114	76	64	DIN 6335 HA	▲
D1122.08.A0660C	6,6	8	114	76	64	DIN 6335 HA	△
D1122.08.A0670C	6,7	8	114	76	64	DIN 6335 HA	△
D1122.08.A0680C	6,8	8	114	76	64	DIN 6335 HA	▲
D1122.08.A0690C	6,9	8	114	76	64	DIN 6335 HA	△
D1122.08.A0700C	7	8	114	76	64	DIN 6335 HA	▲
D1122.08.A0710C	7,1	8	114	76	64	DIN 6335 HA	△
D1122.08.A0720C	7,2	8	114	76	64	DIN 6335 HA	△
D1122.08.A0730C	7,3	8	114	76	64	DIN 6335 HA	△
D1122.08.A0740C	7,4	8	114	76	64	DIN 6335 HA	△
D1122.08.A0750C	7,5	8	114	76	64	DIN 6335 HA	▲
D1122.08.A0760C	7,6	8	114	76	64	DIN 6335 HA	△
D1122.08.A0770C	7,7	8	114	76	64	DIN 6335 HA	△
D1122.08.A0780C	7,8	8	114	76	64	DIN 6335 HA	▲
D1122.08.A0790C	7,9	8	114	76	64	DIN 6335 HA	△

P	●
M	-
K	●
N	-
S	-
H	-

Vollhartmetall-Bohrer

Solid carbide drilling tools

D1122



A

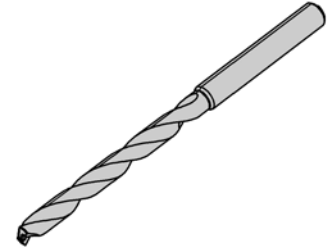
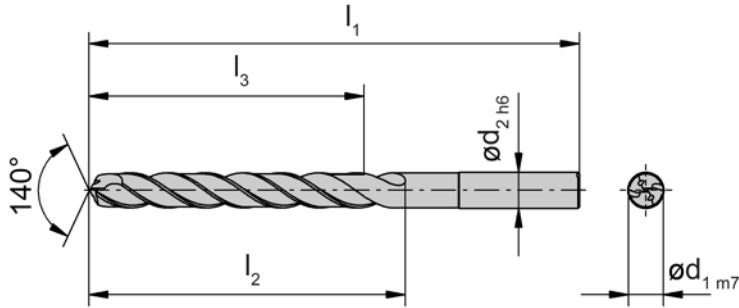
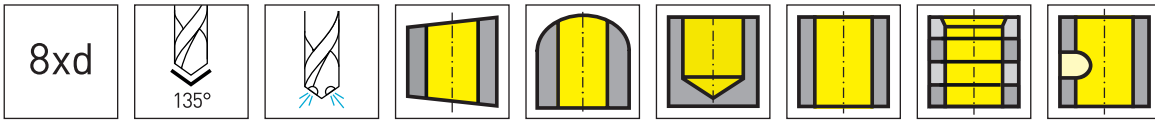

HM-Sorten
Carbide grades

▲ ab Lager
on stock

△ 4 Wochen
4 weeks

Bestellnummer Part number	d ₁	d ₂	l ₁	l ₂	l ₃	Form	ES35
D1122.08.A0800C	8	8	114	76	64	DIN 6335 HA	▲
D1122.08.A0810C	8,1	10	142	95	80	DIN 6335 HA	△
D1122.08.A0820C	8,2	10	142	95	80	DIN 6335 HA	△
D1122.08.A0830C	8,3	10	142	95	80	DIN 6335 HA	△
D1122.08.A0840C	8,4	10	142	95	80	DIN 6335 HA	△
D1122.08.A0850C	8,5	10	142	95	80	DIN 6335 HA	▲
D1122.08.A0860C	8,6	10	142	95	80	DIN 6335 HA	△
D1122.08.A0870C	8,7	10	142	95	80	DIN 6335 HA	△
D1122.08.A0880C	8,8	10	142	95	80	DIN 6335 HA	▲
D1122.08.A0890C	8,9	10	142	95	80	DIN 6335 HA	△
D1122.08.A0900C	9	10	142	95	80	DIN 6335 HA	▲
D1122.08.A0910C	9,1	10	142	95	80	DIN 6335 HA	△
D1122.08.A0920C	9,2	10	142	95	80	DIN 6335 HA	△
D1122.08.A0930C	9,3	10	142	95	80	DIN 6335 HA	△
D1122.08.A0940C	9,4	10	142	95	80	DIN 6335 HA	△
D1122.08.A0950C	9,5	10	142	95	80	DIN 6335 HA	▲
D1122.08.A0960C	9,6	10	142	95	80	DIN 6335 HA	△
D1122.08.A0970C	9,7	10	142	95	80	DIN 6335 HA	△
D1122.08.A0980C	9,8	10	142	95	80	DIN 6335 HA	▲
D1122.08.A0990C	9,9	10	142	95	80	DIN 6335 HA	△
D1122.08.A1000C	10	10	142	95	80	DIN 6335 HA	▲
D1122.08.A1010C	10,1	12	162	114	96	DIN 6335 HA	△
D1122.08.A1020C	10,2	12	162	114	96	DIN 6335 HA	▲
D1122.08.A1030C	10,3	12	162	114	96	DIN 6335 HA	△
D1122.08.A1040C	10,4	12	162	114	96	DIN 6335 HA	△

P	●
M	-
K	●
N	-
S	-
H	-

Vollhartmetall-Bohrer D1122

Solid carbide drilling tools

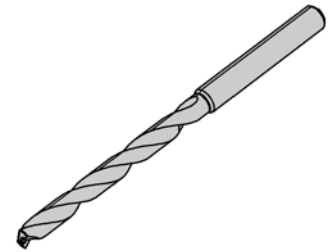
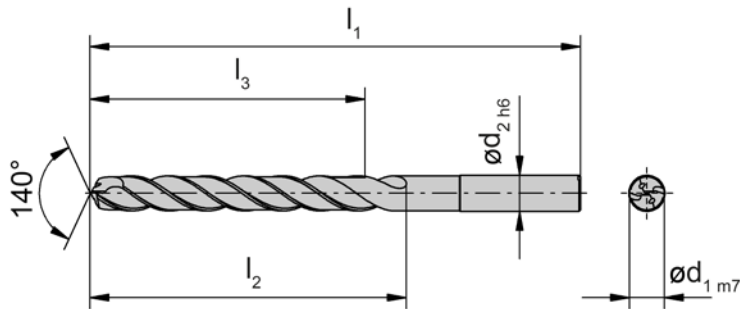
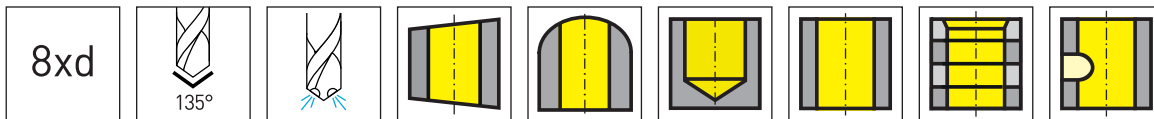

HM-Sorten
Carbide grades

▲ ab Lager
on stock

△ 4 Wochen
4 weeks

Bestellnummer Part number	d ₁	d ₂	l ₁	l ₂	l ₃	Form	ES35
D1122.08.A1050C	10,5	12	162	114	96	DIN 6335 HA	▲
D1122.08.A1060C	10,6	12	162	114	96	DIN 6335 HA	△
D1122.08.A1070C	10,7	12	162	114	96	DIN 6335 HA	△
D1122.08.A1080C	10,8	12	162	114	96	DIN 6335 HA	▲
D1122.08.A1090C	10,9	12	162	114	96	DIN 6335 HA	△
D1122.08.A1100C	11	12	162	114	96	DIN 6335 HA	▲
D1122.08.A1110C	11,1	12	162	114	96	DIN 6335 HA	△
D1122.08.A1120C	11,2	12	162	114	96	DIN 6335 HA	△
D1122.08.A1130C	11,3	12	162	114	96	DIN 6335 HA	△
D1122.08.A1140C	11,4	12	162	114	96	DIN 6335 HA	△
D1122.08.A1150C	11,5	12	162	114	96	DIN 6335 HA	▲
D1122.08.A1160C	11,6	12	162	114	96	DIN 6335 HA	△
D1122.08.A1170C	11,7	12	162	114	96	DIN 6335 HA	△
D1122.08.A1180C	11,8	12	162	114	96	DIN 6335 HA	▲
D1122.08.A1190C	11,9	12	162	114	96	DIN 6335 HA	△
D1122.08.A1200C	12	12	162	114	96	DIN 6335 HA	▲
D1122.08.A1210C	12,1	14	178	133	112	DIN 6335 HA	△
D1122.08.A1220C	12,2	14	178	133	112	DIN 6335 HA	△
D1122.08.A1230C	12,3	14	178	133	112	DIN 6335 HA	△
D1122.08.A1240C	12,4	14	178	133	112	DIN 6335 HA	△
D1122.08.A1250C	12,5	14	178	133	112	DIN 6335 HA	▲
D1122.08.A1260C	12,6	14	178	133	112	DIN 6335 HA	△
D1122.08.A1270C	12,7	14	178	133	112	DIN 6335 HA	△
D1122.08.A1280C	12,8	14	178	133	112	DIN 6335 HA	▲
D1122.08.A1290C	12,9	14	178	133	112	DIN 6335 HA	△

P	●
M	-
K	●
N	-
S	-
H	-

Vollhartmetall-Bohrer

Solid carbide drilling tools

D1122



A

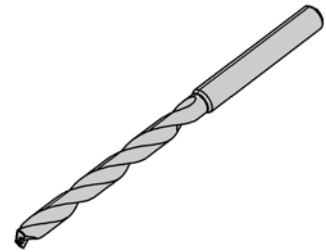
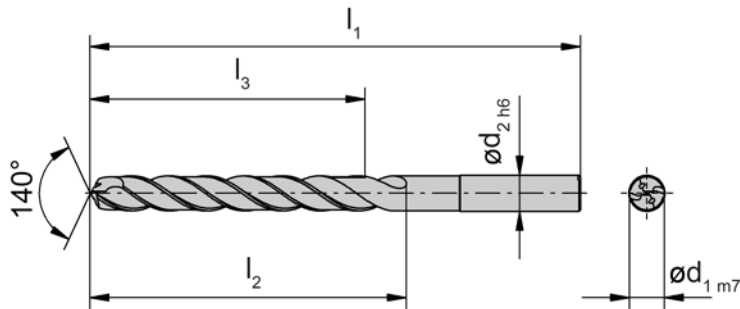
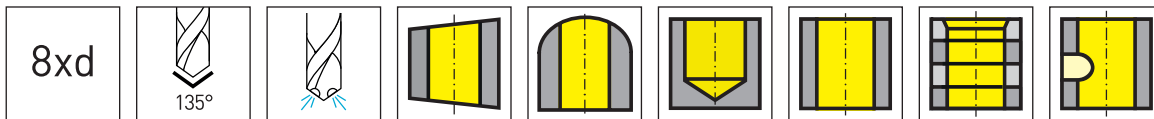

HM-Sorten
Carbide grades

▲ ab Lager
on stock

△ 4 Wochen
4 weeks

Bestellnummer Part number	d ₁	d ₂	l ₁	l ₂	l ₃	Form	ES35
D1122.08.A1300C	13	14	178	133	112	DIN 6335 HA	▲
D1122.08.A1350C	13,5	14	178	133	112	DIN 6335 HA	▲
D1122.08.A1380C	13,8	14	178	133	112	DIN 6335 HA	▲
D1122.08.A1400C	14	14	178	133	112	DIN 6335 HA	▲
D1122.08.A1450C	14,5	16	203	152	128	DIN 6335 HA	▲
D1122.08.A1480C	14,8	16	203	152	128	DIN 6335 HA	▲
D1122.08.A1500C	15	16	203	152	128	DIN 6335 HA	▲
D1122.08.A1550C	15,5	16	203	152	128	DIN 6335 HA	▲
D1122.08.A1580C	15,8	16	203	152	128	DIN 6335 HA	▲
D1122.08.A1600C	16	16	203	152	128	DIN 6335 HA	▲
D1122.08.A1650C	16,5	18	222	171	144	DIN 6335 HA	▲
D1122.08.A1680C	16,8	18	222	171	144	DIN 6335 HA	▲
D1122.08.A1700C	17	18	222	171	144	DIN 6335 HA	▲
D1122.08.A1750C	17,5	18	222	171	144	DIN 6335 HA	▲
D1122.08.A1780C	17,8	18	222	171	144	DIN 6335 HA	▲
D1122.08.A1800C	18	18	222	171	144	DIN 6335 HA	▲
D1122.08.A1850C	18,5	20	243	190	160	DIN 6335 HA	▲
D1122.08.A1880C	18,8	20	243	190	160	DIN 6335 HA	▲
D1122.08.A1900C	19	20	243	190	160	DIN 6335 HA	▲
D1122.08.A1950C	19,5	20	243	190	160	DIN 6335 HA	▲
D1122.08.A1980C	19,8	20	243	190	160	DIN 6335 HA	▲
D1122.08.A2000C	20	20	243	190	160	DIN 6335 HA	▲

P	●
M	-
K	●
N	-
S	-
H	-

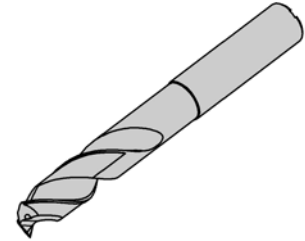
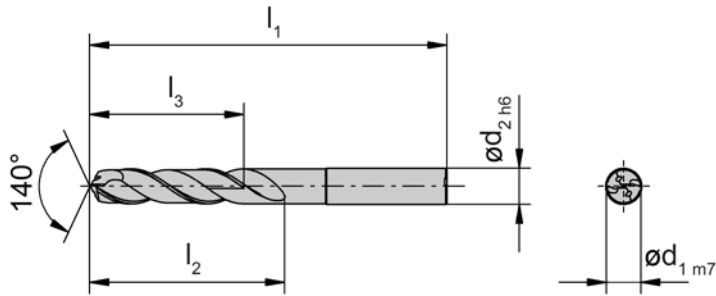
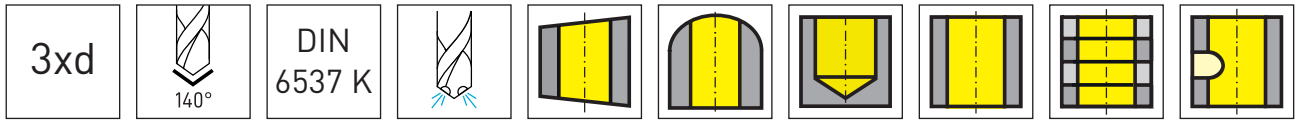

HM-Sorten
Carbide grades

▲ ab Lager
on stock

△ 4 Wochen
4 weeks

Bestellnummer Part number	d ₁	d ₂	l ₁	l ₂	l ₃	Form	BM35
DDM.03.01.03000	3	6	62	20	14	HA	▲
DDM.03.01.03100	3,1	6	62	20	14	HA	△
DDM.03.01.03200	3,2	6	62	20	14	HA	△
DDM.03.01.03300	3,3	6	62	20	14	HA	▲
DDM.03.01.03400	3,4	6	62	20	14	HA	△
DDM.03.01.03500	3,5	6	62	20	14	HA	△
DDM.03.01.03600	3,6	6	62	20	14	HA	△
DDM.03.01.03700	3,7	6	62	20	14	HA	△
DDM.03.01.03800	3,8	6	66	24	17	HA	△
DDM.03.01.03900	3,9	6	66	24	17	HA	△

Optional in Schaftform DIN6535-HE / Whistle Notch erhältlich
Optionally available in shank form DIN 6535-HE / Whistle Notch

P	o
M	•
K	-
N	•
S	•
H	-

Vollhartmetall-Bohrer

Solid carbide drilling tools

DDM



A

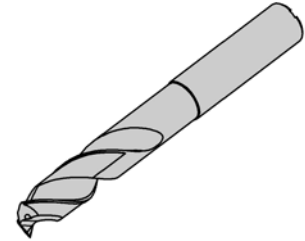
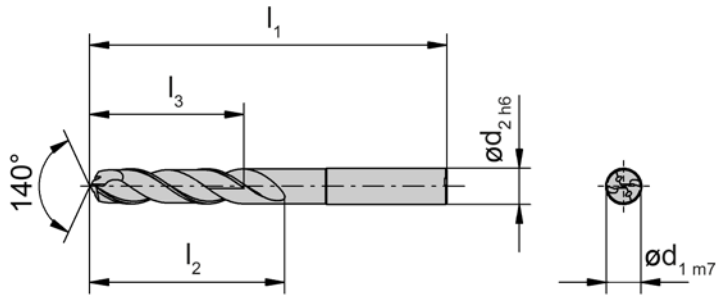
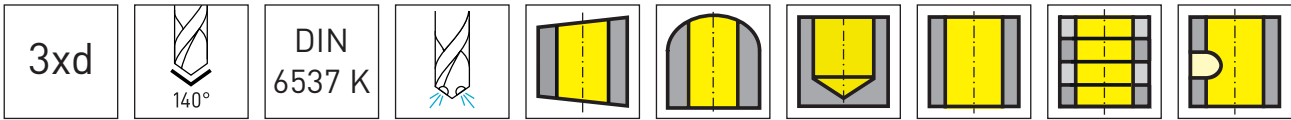

HM-Sorten
Carbide grades

▲ ab Lager
on stock

△ 4 Wochen
4 weeks

Bestellnummer Part number	d ₁	d ₂	l ₁	l ₂	l ₃	Form	BM35
DDM.03.01.04000	4	6	66	24	17	HA	▲
DDM.03.01.04100	4,1	6	66	24	17	HA	△
DDM.03.01.04200	4,2	6	66	24	17	HA	▲
DDM.03.01.04300	4,3	6	66	24	17	HA	△
DDM.03.01.04400	4,4	6	66	24	17	HA	△
DDM.03.01.04500	4,5	6	66	24	17	HA	▲
DDM.03.01.04600	4,6	6	66	24	17	HA	△
DDM.03.01.04650	4,65	6	66	24	17	HA	△
DDM.03.01.04700	4,7	6	66	24	17	HA	△
DDM.03.01.04800	4,8	6	66	28	20	HA	▲
DDM.03.01.04900	4,9	6	66	28	20	HA	△
DDM.03.01.05000	5	6	66	28	20	HA	▲
DDM.03.01.05100	5,1	6	66	28	20	HA	△
DDM.03.01.05200	5,2	6	66	28	20	HA	△
DDM.03.01.05300	5,3	6	66	28	20	HA	△
DDM.03.01.05400	5,4	6	66	28	20	HA	△
DDM.03.01.05500	5,5	6	66	28	20	HA	▲
DDM.03.01.05550	5,55	6	66	28	20	HA	△
DDM.03.01.05600	5,6	6	66	28	20	HA	△
DDM.03.01.05700	5,7	6	66	28	20	HA	△
DDM.03.01.05800	5,8	6	66	28	20	HA	▲
DDM.03.01.05900	5,9	6	66	28	20	HA	△

Optional in Schaffform DIN6535-HE / Whistle Notch erhältlich
Optionally available in shank form DIN 6535-HE / Whistle Notch

P	o
M	•
K	-
N	•
S	•
H	-

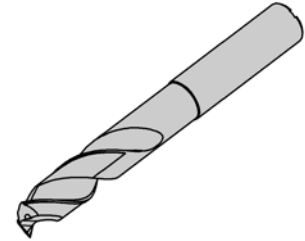
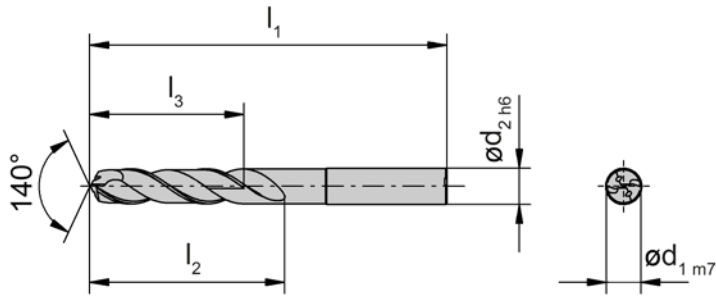
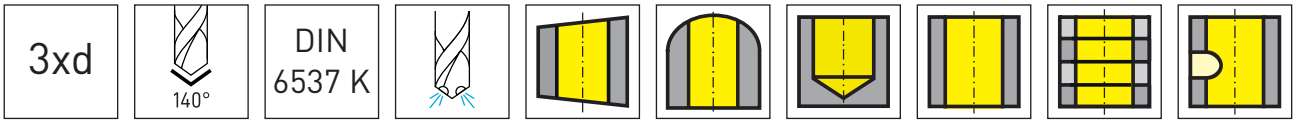

HM-Sorten
Carbide grades

▲ ab Lager
on stock

△ 4 Wochen
4 weeks

Bestellnummer Part number	d ₁	d ₂	l ₁	l ₂	l ₃	Form	BM35
DDM.03.01.06000	6	6	66	28	20	HA	▲
DDM.03.01.06100	6,1	8	79	34	24	HA	△
DDM.03.01.06200	6,2	8	79	34	24	HA	△
DDM.03.01.06300	6,3	8	79	34	24	HA	△
DDM.03.01.06400	6,4	8	79	34	24	HA	△
DDM.03.01.06500	6,5	8	79	34	24	HA	▲
DDM.03.01.06600	6,6	8	79	34	24	HA	△
DDM.03.01.06700	6,7	8	79	34	24	HA	△
DDM.03.01.06800	6,8	8	79	34	24	HA	▲
DDM.03.01.06900	6,9	8	79	34	24	HA	△
DDM.03.01.07000	7	8	79	34	24	HA	▲
DDM.03.01.07100	7,1	8	79	41	29	HA	△
DDM.03.01.07200	7,2	8	79	41	29	HA	△
DDM.03.01.07300	7,3	8	79	41	29	HA	△
DDM.03.01.07400	7,4	8	79	41	29	HA	△
DDM.03.01.07500	7,5	8	79	41	29	HA	▲
DDM.03.01.07600	7,6	8	79	41	29	HA	△
DDM.03.01.07700	7,7	8	79	41	29	HA	△
DDM.03.01.07800	7,8	8	79	41	29	HA	▲
DDM.03.01.07900	7,9	8	79	41	29	HA	△

Optional in Schaftform DIN6535-HE / Whistle Notch erhältlich
Optionally available in shank form DIN 6535-HE / Whistle Notch

P	o
M	•
K	-
N	•
S	•
H	-

Vollhartmetall-Bohrer

Solid carbide drilling tools

DDM



A

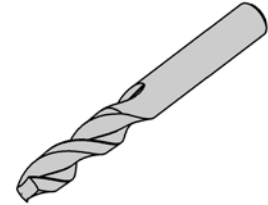
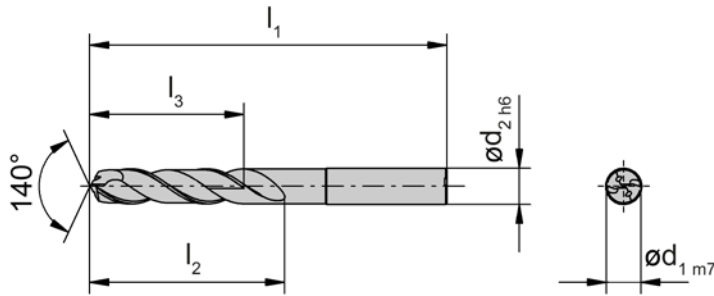
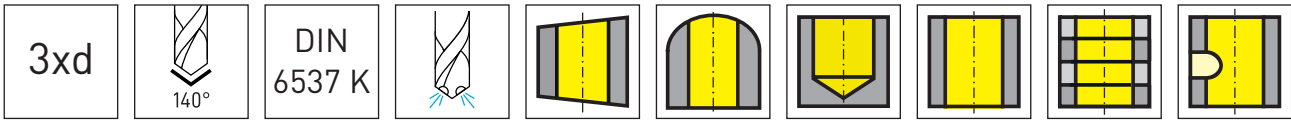

HM-Sorten
Carbide grades

▲ ab Lager
on stock

△ 4 Wochen
4 weeks

Bestellnummer Part number	d ₁	d ₂	l ₁	l ₂	l ₃	Form	BM35
DDM.03.01.08000	8	8	79	41	29	HA	▲
DDM.03.01.08100	8,1	10	89	47	35	HA	△
DDM.03.01.08200	8,2	10	89	47	35	HA	△
DDM.03.01.08300	8,3	10	89	47	35	HA	△
DDM.03.01.08400	8,4	10	89	47	35	HA	△
DDM.03.01.08500	8,5	10	89	47	35	HA	▲
DDM.03.01.08600	8,6	10	89	47	35	HA	△
DDM.03.01.08700	8,7	10	89	47	35	HA	△
DDM.03.01.08800	8,8	10	89	47	35	HA	△
DDM.03.01.08900	8,9	10	89	47	35	HA	△
DDM.03.01.09000	9	10	89	47	35	HA	▲
DDM.03.01.09100	9,1	10	89	47	35	HA	△
DDM.03.01.09200	9,2	10	89	47	35	HA	△
DDM.03.01.09250	9,25	10	89	47	35	HA	△
DDM.03.01.09300	9,3	10	89	47	35	HA	△
DDM.03.01.09400	9,4	10	89	47	35	HA	△
DDM.03.01.09500	9,5	10	89	47	35	HA	▲
DDM.03.01.09600	9,6	10	89	47	35	HA	△
DDM.03.01.09700	9,7	10	89	47	35	HA	△
DDM.03.01.09800	9,8	10	89	47	35	HA	△
DDM.03.01.09900	9,9	10	89	47	35	HA	△

Optional in Schaffform DIN6535-HE / Whistle Notch erhältlich
Optionally available in shank form DIN 6535-HE / Whistle Notch

P	o
M	•
K	-
N	•
S	•
H	-

Vollhartmetall-Bohrer

Solid carbide drilling tools

DDM

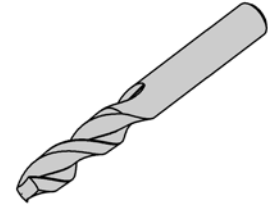
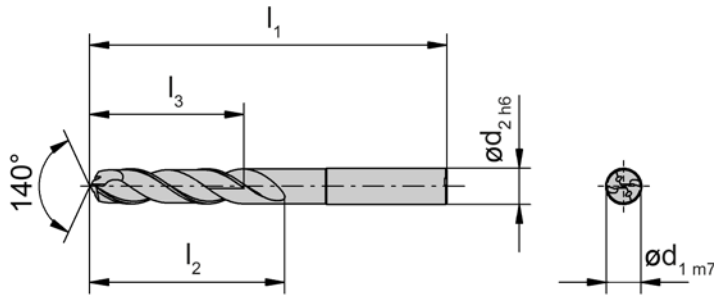
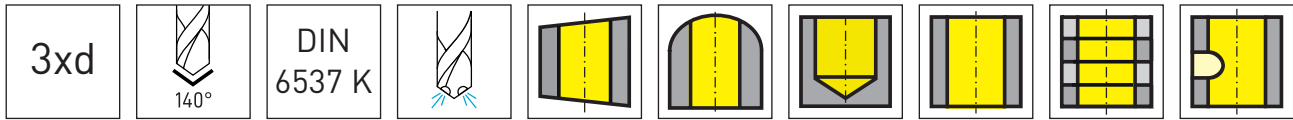

HM-Sorten
Carbide grades

▲ ab Lager
on stock

△ 4 Wochen
4 weeks

Bestellnummer Part number	d ₁	d ₂	l ₁	l ₂	l ₃	Form	BM35
DDM.03.01.10000	10	10	89	47	35	HA	▲
DDM.03.01.10100	10,1	12	102	55	40	HA	△
DDM.03.01.10200	10,2	12	102	55	40	HA	△
DDM.03.01.10300	10,3	12	102	55	40	HA	△
DDM.03.01.10400	10,4	12	102	55	40	HA	△
DDM.03.01.10500	10,5	12	102	55	40	HA	▲
DDM.03.01.10600	10,6	12	102	55	40	HA	△
DDM.03.01.10700	10,7	12	102	55	40	HA	△
DDM.03.01.10800	10,8	12	102	55	40	HA	△
DDM.03.01.10900	10,9	12	102	55	40	HA	△
DDM.03.01.11000	11	12	102	55	40	HA	▲
DDM.03.01.11100	11,1	12	102	55	40	HA	△
DDM.03.01.11200	11,2	12	102	55	40	HA	▲
DDM.03.01.11300	11,3	12	102	55	40	HA	△
DDM.03.01.11400	11,4	12	102	55	40	HA	△
DDM.03.01.11500	11,5	12	102	55	40	HA	▲
DDM.03.01.11600	11,6	12	102	55	40	HA	△
DDM.03.01.11700	11,7	12	102	55	40	HA	△
DDM.03.01.11800	11,8	12	102	55	40	HA	△
DDM.03.01.11900	11,9	12	102	55	40	HA	△

Optional in Schaftform DIN6535-HE / Whistle Notch erhältlich
Optionally available in shank form DIN 6535-HE / Whistle Notch

P	o
M	•
K	-
N	•
S	•
H	-

Vollhartmetall-Bohrer

Solid carbide drilling tools

DDM



A

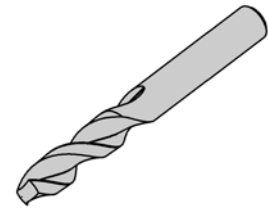
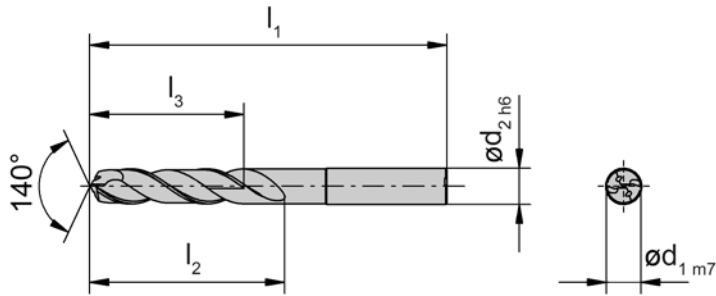
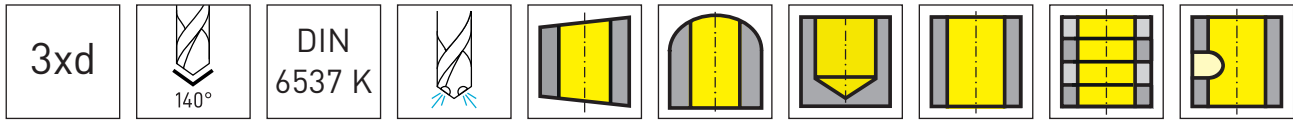

HM-Sorten
Carbide grades

▲ ab Lager
on stock

△ 4 Wochen
4 weeks

Bestellnummer Part number	d ₁	d ₂	l ₁	l ₂	l ₃	Form	BM35
DDM.03.01.12000	12	12	102	55	40	HA	▲
DDM.03.01.12500	12,5	14	107	60	43	HA	△
DDM.03.01.12800	12,8	14	107	60	43	HA	△
DDM.03.01.13000	13	14	107	60	43	HA	▲
DDM.03.01.13500	13,5	14	107	60	43	HA	△
DDM.03.01.13800	13,8	14	107	60	43	HA	△
DDM.03.01.14000	14	14	107	60	43	HA	▲
DDM.03.01.14500	14,5	16	115	65	45	HA	△
DDM.03.01.14800	14,8	16	115	65	45	HA	△
DDM.03.01.15000	15	16	115	65	45	HA	△
DDM.03.01.15500	15,5	16	115	65	45	HA	△
DDM.03.01.15800	15,8	16	115	65	45	HA	△
DDM.03.01.16000	16	16	115	65	45	HA	△
DDM.03.01.16500	16,5	18	123	73	51	HA	△
DDM.03.01.16800	16,8	18	123	73	51	HA	△
DDM.03.01.17000	17	18	123	73	51	HA	△
DDM.03.01.17500	17,5	18	123	73	51	HA	△
DDM.03.01.17800	17,8	18	123	73	51	HA	△
DDM.03.01.18000	18	18	123	73	51	HA	△
DDM.03.01.18500	18,5	20	131	79	55	HA	△
DDM.03.01.18800	18,8	20	131	79	55	HA	△
DDM.03.01.19000	19	20	131	79	55	HA	△
DDM.03.01.19500	19,5	20	131	79	55	HA	△
DDM.03.01.19800	19,8	20	131	79	55	HA	△
DDM.03.01.20000	20	20	131	79	55	HA	△

Optional in Schaffform DIN6535-HE / Whistle Notch erhältlich
Optionally available in shank form DIN 6535-HE / Whistle Notch

P	o
M	•
K	-
N	•
S	•
H	-

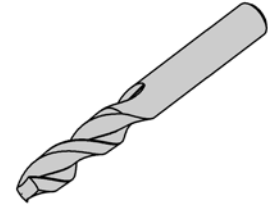
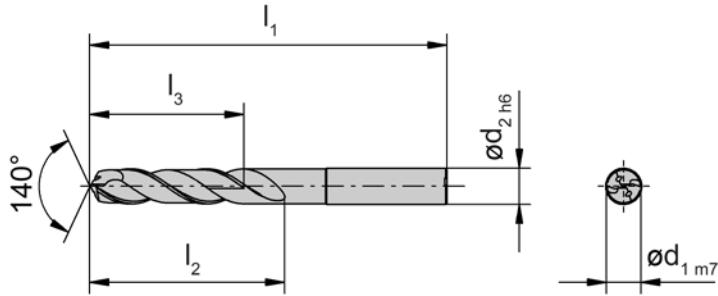
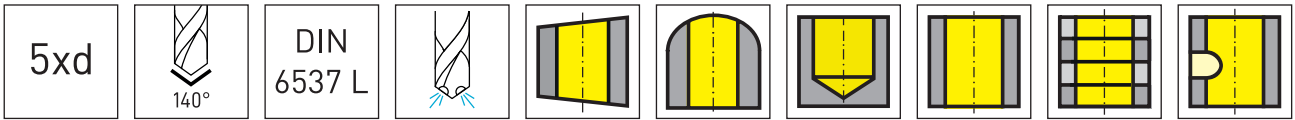

HM-Sorten
Carbide grades

▲ ab Lager
on stock

△ 4 Wochen
4 weeks

Bestellnummer Part number	d ₁	d ₂	l ₁	l ₂	l ₃	Form	BM35
DDM.05.01.03000	3	6	66	28	23	HA	▲
DDM.05.01.03100	3,1	6	66	28	23	HA	△
DDM.05.01.03200	3,2	6	66	28	23	HA	△
DDM.05.01.03300	3,3	6	66	28	23	HA	▲
DDM.05.01.03400	3,4	6	66	28	23	HA	△
DDM.05.01.03500	3,5	6	66	28	23	HA	△
DDM.05.01.03600	3,6	6	66	28	23	HA	△
DDM.05.01.03700	3,7	6	66	28	23	HA	△
DDM.05.01.03800	3,8	6	74	36	29	HA	△
DDM.05.01.03900	3,9	6	74	36	29	HA	△

Optional in Schaftform DIN6535-HE / Whistle Notch erhältlich
Optionally available in shank form DIN 6535-HE / Whistle Notch

P	o
M	•
K	-
N	•
S	•
H	-

Vollhartmetall-Bohrer

Solid carbide drilling tools

DDM



A

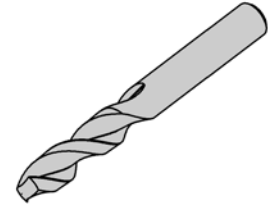
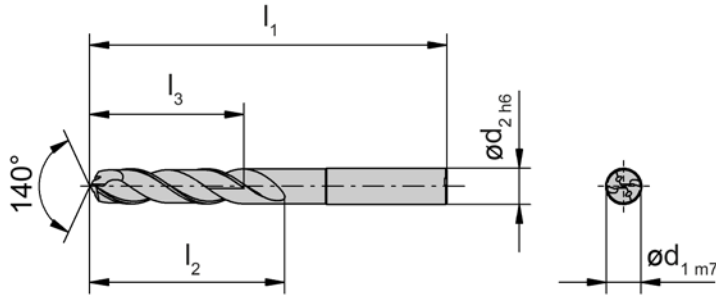
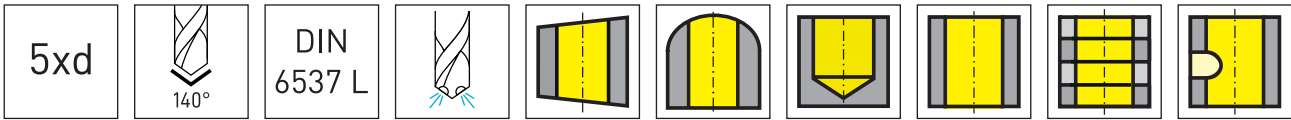

HM-Sorten
Carbide grades

▲ ab Lager
on stock

△ 4 Wochen
4 weeks

Bestellnummer Part number	d ₁	d ₂	l ₁	l ₂	l ₃	Form	BM35
DDM.05.01.04000	4	6	74	36	29	HA	▲
DDM.05.01.04100	4,1	6	74	36	29	HA	△
DDM.05.01.04200	4,2	6	74	36	29	HA	▲
DDM.05.01.04300	4,3	6	74	36	29	HA	▲
DDM.05.01.04400	4,4	6	74	36	29	HA	△
DDM.05.01.04500	4,5	6	74	36	29	HA	▲
DDM.05.01.04600	4,6	6	74	36	29	HA	▲
DDM.05.01.04700	4,7	6	74	36	29	HA	▲
DDM.05.01.04800	4,8	6	82	44	35	HA	▲
DDM.05.01.04900	4,9	6	82	44	35	HA	△
DDM.05.01.05000	5	6	82	44	35	HA	▲
DDM.05.01.05100	5,1	6	82	44	35	HA	▲
DDM.05.01.05200	5,2	6	82	44	35	HA	▲
DDM.05.01.05300	5,3	6	82	44	35	HA	△
DDM.05.01.05400	5,4	6	82	44	35	HA	△
DDM.05.01.05500	5,5	6	82	44	35	HA	▲
DDM.05.01.05600	5,6	6	82	44	35	HA	△
DDM.05.01.05700	5,7	6	82	44	35	HA	△
DDM.05.01.05800	5,8	6	82	44	35	HA	▲
DDM.05.01.05900	5,9	6	82	44	35	HA	△

Optional in Schaftform DIN6535-HE / Whistle Notch erhältlich
Optionally available in shank form DIN 6535-HE / Whistle Notch

P	o
M	•
K	-
N	•
S	•
H	-

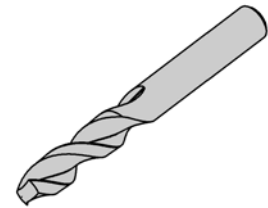
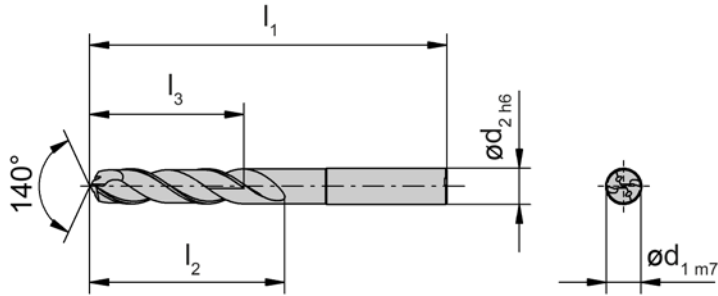
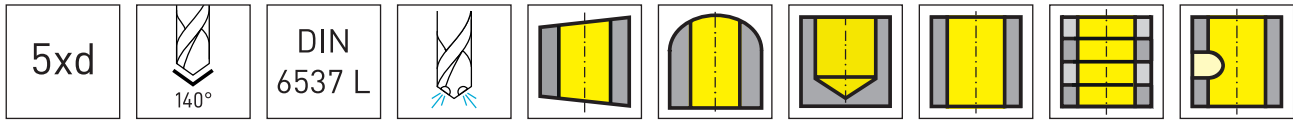

HM-Sorten
Carbide grades

▲ ab Lager
on stock

△ 4 Wochen
4 weeks

Bestellnummer Part number	d ₁	d ₂	l ₁	l ₂	l ₃	Form	BM35
DDM.05.01.06000	6	6	82	44	35	HA	▲
DDM.05.01.06100	6,1	8	91	53	43	HA	△
DDM.05.01.06200	6,2	8	91	53	43	HA	▲
DDM.05.01.06300	6,3	8	91	53	43	HA	△
DDM.05.01.06400	6,4	8	91	53	43	HA	△
DDM.05.01.06500	6,5	8	91	53	43	HA	▲
DDM.05.01.06600	6,6	8	91	53	43	HA	▲
DDM.05.01.06700	6,7	8	91	53	43	HA	△
DDM.05.01.06800	6,8	8	91	53	43	HA	▲
DDM.05.01.06900	6,9	8	91	53	43	HA	▲
DDM.05.01.07000	7	8	91	53	43	HA	▲
DDM.05.01.07100	7,1	8	91	53	43	HA	△
DDM.05.01.07200	7,2	8	91	53	43	HA	△
DDM.05.01.07300	7,3	8	91	53	43	HA	△
DDM.05.01.07400	7,4	8	91	53	43	HA	▲
DDM.05.01.07500	7,5	8	91	53	43	HA	▲
DDM.05.01.07600	7,6	8	91	53	43	HA	△
DDM.05.01.07700	7,7	8	91	53	43	HA	△
DDM.05.01.07800	7,8	8	91	53	43	HA	▲
DDM.05.01.07900	7,9	8	91	53	43	HA	△

Optional in Schaftform DIN6535-HE / Whistle Notch erhältlich
Optionally available in shank form DIN 6535-HE / Whistle Notch

P	o
M	•
K	-
N	•
S	•
H	-

Vollhartmetall-Bohrer

Solid carbide drilling tools

DDM



A

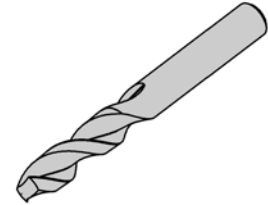
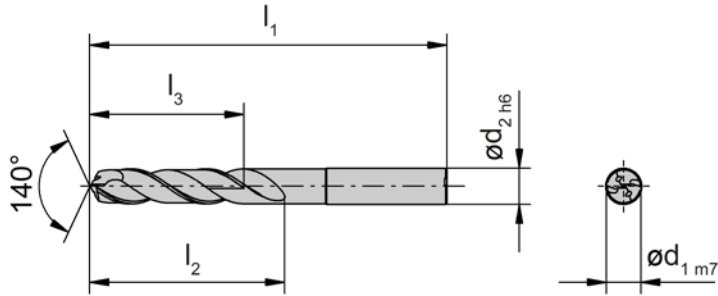
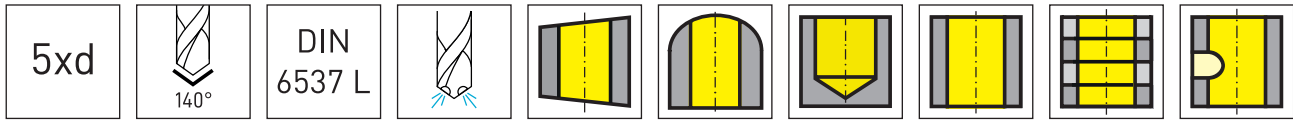

HM-Sorten
Carbide grades

▲ ab Lager
on stock

△ 4 Wochen
4 weeks

Bestellnummer Part number	d ₁	d ₂	l ₁	l ₂	l ₃	Form	BM35
DDM.05.01.08000	8	8	91	53	43	HA	▲
DDM.05.01.08100	8,1	10	103	61	49	HA	△
DDM.05.01.08200	8,2	10	103	61	49	HA	▲
DDM.05.01.08300	8,3	10	103	61	49	HA	△
DDM.05.01.08400	8,4	10	103	61	49	HA	△
DDM.05.01.08500	8,5	10	103	61	49	HA	▲
DDM.05.01.08600	8,6	10	103	61	49	HA	△
DDM.05.01.08700	8,7	10	103	61	49	HA	△
DDM.05.01.08800	8,8	10	103	61	49	HA	▲
DDM.05.01.08900	8,9	10	103	61	49	HA	△
DDM.05.01.09000	9	10	103	61	49	HA	▲
DDM.05.01.09100	9,1	10	103	61	49	HA	△
DDM.05.01.09200	9,2	10	103	61	49	HA	△
DDM.05.01.09300	9,3	10	103	61	49	HA	▲
DDM.05.01.09400	9,4	10	103	61	49	HA	△
DDM.05.01.09500	9,5	10	103	61	49	HA	▲
DDM.05.01.09600	9,6	10	103	61	49	HA	△
DDM.05.01.09700	9,7	10	103	61	49	HA	△
DDM.05.01.09800	9,8	10	103	61	49	HA	▲
DDM.05.01.09900	9,9	10	103	61	49	HA	△

Optional in Schaftform DIN6535-HE / Whistle Notch erhältlich
Optionally available in shank form DIN 6535-HE / Whistle Notch

P	o
M	•
K	-
N	•
S	•
H	-

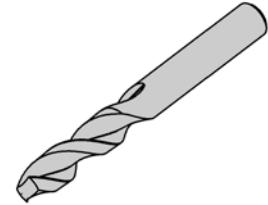
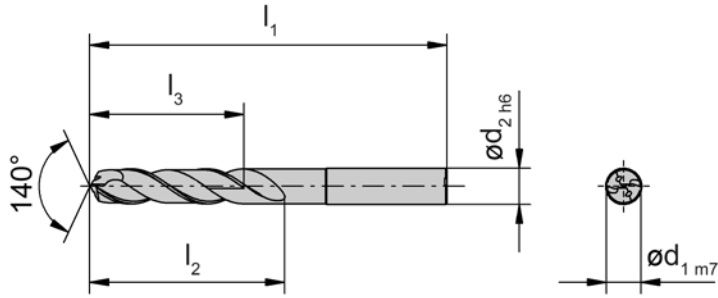
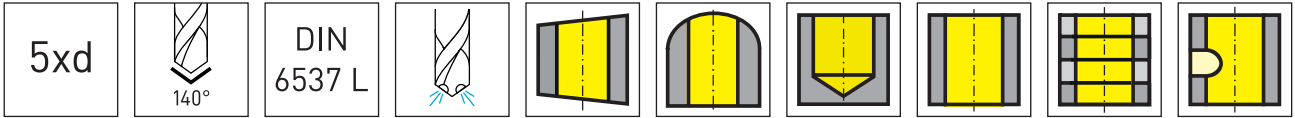

HM-Sorten
Carbide grades

▲ ab Lager
on stock

△ 4 Wochen
4 weeks

Bestellnummer Part number	d ₁	d ₂	l ₁	l ₂	l ₃	Form	BM35
DDM.05.01.10000	10	10	103	61	49	HA	▲
DDM.05.01.10100	10,1	12	118	71	56	HA	△
DDM.05.01.10200	10,2	12	118	71	56	HA	▲
DDM.05.01.10300	10,3	12	118	71	56	HA	△
DDM.05.01.10400	10,4	12	118	71	56	HA	△
DDM.05.01.10500	10,5	12	118	71	56	HA	▲
DDM.05.01.10600	10,6	12	118	71	56	HA	△
DDM.05.01.10700	10,7	12	118	71	56	HA	△
DDM.05.01.10800	10,8	12	118	71	56	HA	△
DDM.05.01.10900	10,9	12	118	71	56	HA	△
DDM.05.01.11000	11	12	118	71	56	HA	▲
DDM.05.01.11100	11,1	12	118	71	56	HA	△
DDM.05.01.11200	11,2	12	118	71	56	HA	△
DDM.05.01.11300	11,3	12	118	71	56	HA	△
DDM.05.01.11400	11,4	12	118	71	56	HA	△
DDM.05.01.11500	11,5	12	118	71	56	HA	▲
DDM.05.01.11600	11,6	12	118	71	56	HA	△
DDM.05.01.11700	11,7	12	118	71	56	HA	△
DDM.05.01.11800	11,8	12	118	71	56	HA	△
DDM.05.01.11900	11,9	12	118	71	56	HA	△
DDM.05.01.12000	12	12	118	71	56	HA	▲
DDM.05.01.12500	12,5	14	124	77	60	HA	▲
DDM.05.01.12800	12,8	14	124	77	60	HA	△

Optional in Schaffform DIN6535-HE / Whistle Notch erhältlich
Optionally available in shank form DIN 6535-HE / Whistle Notch

P	o
M	•
K	-
N	•
S	•
H	-

Vollhartmetall-Bohrer

Solid carbide drilling tools

DDM



A

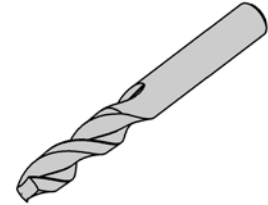
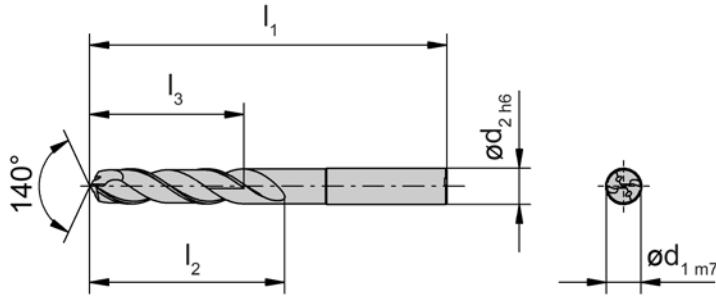
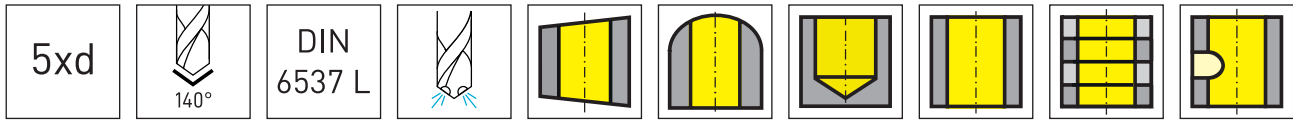

HM-Sorten
Carbide grades

▲ ab Lager
on stock

△ 4 Wochen
4 weeks

Bestellnummer Part number	d ₁	d ₂	l ₁	l ₂	l ₃	Form	BM35
DDM.05.01.13000	13	14	124	77	60	HA	▲
DDM.05.01.13500	13,5	14	124	77	60	HA	▲
DDM.05.01.13800	13,8	14	124	77	60	HA	△
DDM.05.01.14000	14	14	124	77	60	HA	▲
DDM.05.01.14500	14,5	16	133	83	63	HA	△
DDM.05.01.14800	14,8	16	133	83	63	HA	△
DDM.05.01.15000	15	16	133	83	63	HA	△
DDM.05.01.15500	15,5	16	133	83	63	HA	△
DDM.05.01.15800	15,8	16	133	83	63	HA	△
DDM.05.01.16000	16	16	133	83	63	HA	△
DDM.05.01.16500	16,5	18	143	93	71	HA	△
DDM.05.01.16800	16,8	18	143	93	71	HA	△
DDM.05.01.17000	17	18	143	93	71	HA	△
DDM.05.01.17500	17,5	18	143	93	71	HA	△
DDM.05.01.17800	17,8	18	143	93	71	HA	△
DDM.05.01.18000	18	18	143	93	71	HA	△
DDM.05.01.18500	18,5	20	153	101	77	HA	△
DDM.05.01.18800	18,8	20	153	101	77	HA	△
DDM.05.01.19000	19	20	153	101	77	HA	△
DDM.05.01.19500	19,5	20	153	101	77	HA	△
DDM.05.01.19800	19,8	20	153	101	77	HA	△
DDM.05.01.20000	20	20	153	101	77	HA	△

Optional in Schaftform DIN6535-HE / Whistle Notch erhältlich
Optionally available in shank form DIN 6535-HE / Whistle Notch

P	o
M	•
K	-
N	•
S	•
H	-

1	2	3	4	5	6	7	8	9	10	11	12	13	14	15	16	17	18	19	20	21
---	---	---	---	---	---	---	---	---	----	----	----	----	----	----	----	----	----	----	----	----

D 1 1 2 2 . 0 5 . A 0 8 5 0 C N E S 3 5

1	D = Bohrwerkzeug
2	Generation
3	<p>Ausführung 1</p> <p>1 = Spiralbohrer Spitzenwinkel < 180°, bis 12xD 2 = Spiralbohrer Spitzenwinkel = 180° 3 = Stufenbohrer 4 = Mikrobohrer 5 = Tieflochbohrer (> 12xD) 6 = Aufbohrer 7 = Bohrreibahle 8 9 0</p>
4	<p>Ausführung 2</p> <p>1 = Zylindrisch, z=2, Spanraum gerade 2 = Zylindrisch, z=2, Spanraum spiralisiert 3 = Zylindrisch, z=3, Spanraum spiralisiert 4 = Zylindrisch, z=4, Spanraum spiralisiert 5 6 7 8 9 0</p>
5	<p>Einsatzgebiet</p> <p>1 = Universal 2 = Spezialist ISO P & K 3 = Spezialist ISO M & S 4 = Spezialist ISO N 5 = Spezialist ISO S 6 = Spezialist Titan 7 = Spezialist ISO K 8 = Spezialist ISO H 9 0</p>
6	Generation

7-8	<p>Bohrtiefe</p> <p>03 ≈ 3 x DC (DIN 6537 kurz) 05 ≈ 5 x DC (DIN 6537 lang) 08 ≈ 8 x DC 12 ≈ 12 x DC ...</p>
9	Trennzeichen
10	<p>Schaftform DIN 6535</p> <p>A = Zylinderschaft E = Whistle-Notch-Schaft</p>
11-14	<p>Schneiddurchmesser [mm] x 0,01</p> <p>Gewindegröße für Kernlochbohrer mit Fase</p>
15	<p>Innenkühlung</p> <p>C = Mit IK Ohne = keine IK</p>
16	Kennzeichen für Nachschliff (Optional)
17	Leerzeichen
18-21	Sorte

1	2	3	4	5	6	7	8	9	10	11	12	13	14	15	16	17	18	19	20	21
---	---	---	---	---	---	---	---	---	----	----	----	----	----	----	----	----	----	----	----	----

D 1 1 2 2 . 0 5 . A 0 8 5 0 C N E S 3 5

1	D = Drilling tool
2	Generation
3	Version 1 1 = Twist drill point angle < 180°, up to 12xD 2 = Twist drill point angle = 180° 3 = Step drill 4 = Micro drill 5 = Deep hole drill (> 12xD) 6 = Counter bore 7 = Drill reamer 8 9 0
4	Version 2 1 = Cylindrical, z=2, straight chip space 2 = Cylindrical, z=2, spiralised chip space 3 = Cylindrical, z=3, spiralised chip space 4 = Cylindrical, z=4, spiralised chip space 5 6 7 8 9 0
5	Field of application 1 = Universal 2 = Specialist ISO P & K 3 = Specialist ISO M & S 4 = Specialist ISO N 5 = Specialist ISO S 6 = Specialist Titanium 7 = Specialist ISO K 8 = Specialist ISO H 9 0
6	Generation

7-8	Drilling depth 03 ≈ 3 x DC (DIN 6537 short) 05 ≈ 5 x DC (DIN 6537 long) 08 ≈ 8 x DC 12 ≈ 12 x DC ...
9	Separator
10	Shank form DIN 6535 A = Cylindrical shank E = Whistle Notch shank
11-14	Cutting diameter [mm] x 0,01 Thread size for core drill with chamfer
15	Internal cooling C = With IC Without = no IC
16	Indicator for regrinding (optional)
17	Blank
18-21	Carbide grade

Werkstoff Material		Materialgruppe Material group	Härte (HB) Hardness Brinell	Zugfestigkeit R _m [N/mm ²] Tensile Strength	
P	unlegierter Stahl Carbon steel	~ 0,2 % C	P1.1	125	430
		~ 0,4% C geglüht annealed	P1.2	190	610
		~ 0,4% C vergütet quenched	P1.3	210	640
		~ 0,6% C geglüht annealed	P1.4	190	610
		~ 0,6% C vergütet quenched	P1.5	300	1000
		Automatenstahl Free cutting steel	P1.6	220	750
	niedrig legierter Stahl (<5%) Alloyed steel	geglüht annealed	P2.1	180	590
		vergütet quenched	P2.2	280	960
		vergütet quenched	P2.3	350	1250
		vergütet quenched	P2.4	430	1450
	hochlegierter Stahl (>5%) high alloyed steel	geglüht annealed	P3.1	200	680
		gehärtet hardened	P3.2	350	1200
	Stahlguss Cast steel	unlegiert unalloyed	P4.1	180	590
		legiert alloyed	P4.2	220	750
	Sinterstahl Sintered steel	weich soft	P5.1	220	570
	K	Grauguss Grey cast iron	niedrige Festigkeit low tensile strength	K1.1	180
hohe Festigkeit high tensile strength			K1.2	250	350
Kugelgraphitguss Spheroidal graphite cast iron		ferritisch ferritic	K2.1	160	400
		perlitisches perlitic	K2.1	260	700
Temperguss Malleable cast iron		ferritisch ferritic	K3.1	200	400
		perlitisches perlitic	K3.2	260	700
Ausferritisches Gusseisen / ADI Ausferritic spheroidal cast iron / ADI		vergütet quenched	K4.1	260	800
		vergütet quenched	K4.2	350	1050
		vergütet quenched	K4.3	450	1400

Schnittdaten D1122

Cutting Data 1122



A

	Schnittgeschwindigkeit v_c (m/min) / Startwerte Cutting speed v_c (m/min) / Start values	Vorschub f (mm/U) Feed rate (mm/rev)						
		$\varnothing 4$	$\varnothing 6$	$\varnothing 8$	$\varnothing 10$	$\varnothing 12$	$\varnothing 16$	$\varnothing 20$
	100 - 120	0,1	0,15	0,2	0,25	0,3	0,36	0,4
	90 - 110	0,1	0,15	0,2	0,25	0,3	0,36	0,4
	70 - 90	0,09	0,14	0,18	0,22	0,26	0,3	0,35
	80 - 100	0,1	0,15	0,2	0,25	0,3	0,36	0,4
	60 - 80	0,1	0,15	0,2	0,25	0,3	0,36	0,4
	90 - 110	0,09	0,14	0,18	0,22	0,26	0,3	0,35
	80 - 100	0,08	0,12	0,16	0,2	0,24	0,28	0,3
	65 - 85	0,08	0,12	0,16	0,2	0,24	0,28	0,3
	40 - 60	0,1	0,15	0,2	0,25	0,3	0,36	0,4
	40 - 60	0,08	0,12	0,16	0,2	0,24	0,28	0,3
	70 - 100	0,1	0,15	0,2	0,25	0,3	0,36	0,4
	70 - 100	0,08	0,12	0,16	0,2	0,24	0,28	0,3
	40 - 60	0,1	0,15	0,2	0,25	0,3	0,36	0,4
	90 - 110	0,09	0,14	0,18	0,22	0,26	0,3	0,35
	80 - 100	0,09	0,14	0,18	0,22	0,26	0,3	0,35
	90 - 120	0,16	0,22	0,28	0,34	0,38	0,44	0,5
	80 - 100	0,15	0,2	0,25	0,3	0,35	0,4	0,45
	90 - 120	0,15	0,2	0,25	0,3	0,35	0,4	0,45
	70 - 90	0,14	0,18	0,22	0,25	0,3	0,35	0,4
	80 - 100	0,16	0,22	0,28	0,34	0,38	0,44	0,5
	60 - 80	0,14	0,18	0,22	0,25	0,3	0,35	0,4
	60 - 80	0,14	0,18	0,22	0,25	0,3	0,35	0,4
	50 - 60	0,08	0,12	0,16	0,2	0,24	0,28	0,3
	20 - 30	0,08	0,12	0,16	0,2	0,24	0,28	0,3

Werkstoff Material		Materialgruppe Material group	Härte (HB) Hardness Brinell	Zugfestigkeit R_m [N/mm ²] Tensile Strength	Beispiel Werkstoff Example Material	
P	unlegierter Stahl Carbon steel	~ 0,2 % C	P1.1	125	430	CK15
		~ 0,4% C geglüht annealed	P1.2	190	610	19Mn6
		~ 0,4% C vergütet quenched	P1.3	210	640	36Mn5
		~ 0,6% C geglüht annealed	P1.4	190	610	C55
		~ 0,6% C vergütet quenched	P1.5	300	1000	CK60
		Automatenstahl Free cutting steel	P1.6	220	750	9SMn28
	niedrig legierter Stahl (<5%) Alloyed steel	geglüht annealed	P2.1	180	590	100Cr6
		vergütet quenched	P2.2	280	960	14NiCr10
		vergütet quenched	P2.3	350	1250	34CrMo4
		vergütet quenched	P2.4	430	1450	55Cr3
	hochlegierter Stahl (>5%) high alloyed steel	geglüht annealed	P3.1	200	680	X10CrAl18
		gehärtet hardened	P3.2	350	1200	X210Cr2
	Stahlguss Cast steel	unlegiert unalloyed	P4.1	180	590	GE200
		legiert alloyed	P4.2	220	750	GX40CrSi28
	Sinterstahl Sintered steel	weich soft	P5.1	220	570	Sint-D39
M	Rostfreier Stahl Stainless steel	martensitisch ferritisch martensitic ferritic	M1.1	200	680	X16Cr13
		austenitisch austenitic	M1.2	300	1000	X6CrNiMo- Ti17-12-2
		austenitisch ferritisch austenitic ferritic	M1.3	230	780	X2CrNiMo- N17-13-3

Schnittdaten DDM

Cutting data



A

	Schnittgeschwindigkeit vc (m/min) / Startwerte Cutting speed vc (m/min) Start values	Vorschub f (mm/U) Feed rate (m/rev)						
		Ø4	Ø6	Ø8	Ø10	Ø12	Ø16	Ø20
	80 - 100	0,1	0,15	0,2	0,25	0,3	0,36	0,4
	90 - 70	0,1	0,15	0,2	0,25	0,3	0,36	0,4
	85 - 60	0,1	0,15	0,2	0,25	0,3	0,36	0,4
	90 - 60	0,1	0,15	0,2	0,25	0,3	0,36	0,4
	80 - 65	0,09	0,14	0,18	0,22	0,26	0,3	0,35
	90 - 70	0,1	0,15	0,2	0,25	0,3	0,36	0,4
	80 - 60	0,1	0,15	0,2	0,25	0,3	0,36	0,4
	70 - 50	0,09	0,14	0,18	0,22	0,26	0,3	0,35
	60 - 40	0,08	0,12	0,16	0,2	0,24	0,28	0,3
	60 - 40	0,08	0,12	0,16	0,2	0,24	0,28	0,3
	80 - 60	0,1	0,15	0,2	0,25	0,3	0,36	0,4
	60 - 40	0,08	0,12	0,16	0,2	0,24	0,28	0,3
	90 - 70	0,1	0,15	0,2	0,25	0,3	0,36	0,4
	90 - 70	0,09	0,14	0,18	0,22	0,26	0,3	0,35
	100 - 80	0,09	0,14	0,18	0,22	0,26	0,3	0,35
	80 - 60	0,08	0,12	0,16	0,2	0,24	0,28	0,3
	40 - 30	0,08	0,1	0,12	0,14	0,16	0,2	0,28
	50 - 40	0,08	0,1	0,12	0,14	0,16	0,2	0,28

Werkstoff Material		Materialgruppe Material group	Härte (HB) Hardness Brinell	Zugfestigkeit R_m [N/mm ²] Tensile Strength	Beispiel Werkstoff Example Material	
N	Al-Legierungen Al-alloys	nicht vergütbar not heat treatable	N1.1	30	AlMg1	
		vergütbar heat treatable	N1.2	100	AlMgSi1	
	Al-Guss- Legierung Al-cast-alloy	< 6% Si	N2.1	80	300	AlMgSi6
		6-10% Si	N2.2	100	320	AlSi7Mg
		10-15 % Si	N2.3	130	450	AlSi12
	Kupfer- Legierungen Copper-alloys	Reinkupfer Pure copper	N3.1	100	340	Cu
		Messing, Bronze Brass	N3.2	90	310	CuZn40Pb
		Messing bleifrei Lead-free brass	N3.3	110	430	CuZn40
		hochfest high strength	N3.4	300	1000	CuZn25Al5- Mn4Fe3
	Graphit Graphite		N4.1			
S	Warmfeste Legierung (Fe) Heat resistant alloy	geglüht annealed	S1.1	200	670	
		gehärtet hardened	S1.2	275	930	
	Warmfeste Legierung (Ni, Co) Heat resistant alloy	geglüht annealed	S2.1	250	840	Inconel 600
		gehärtet hardened	S2.2	350	1200	Inconel 713
	Titan	Titanlegierung α Titanium alloy α	S3.1	120	240	
		Titanlegierung α - β Titanium alloy α - β	S3.2	360	1200	
Titanlegierung β Titanium alloy β		S3.3	410	1400		

Schnittdaten DDM

Cutting Data DDM



A

	Schnittgeschwindigkeit vc (m/min) / Startwerte Cutting speed vc (m/min) Start values	Vorschub f (mm/U) Feed rate (m/rev)						
		Ø4	Ø6	Ø8	Ø10	Ø12	Ø16	Ø20
	300 - 250	0,12	0,18	0,24	0,3	0,35	0,4	0,5
	300 - 250	0,12	0,18	0,24	0,3	0,35	0,4	0,5
	250 - 220	0,12	0,18	0,24	0,3	0,35	0,4	0,5
	220 - 200	0,12	0,18	0,24	0,3	0,35	0,4	0,5
	220 - 180	0,1	0,15	0,2	0,25	0,3	0,36	0,4
	180 - 160	0,1	0,15	0,2	0,25	0,3	0,36	0,4
	160 - 140	0,12	0,18	0,24	0,3	0,35	0,4	0,5
	100 - 80	0,12	0,18	0,24	0,3	0,35	0,4	0,5
	80 - 60	0,08	0,12	0,16	0,2	0,24	0,28	0,3
	45 - 25	0,04	0,06	0,08	0,1	0,12	0,16	0,2
	40 - 30	0,03	0,05	0,07	0,1	0,12	0,16	0,2
	45 - 25	0,04	0,06	0,08	0,1	0,12	0,16	0,2
	30 - 20	0,03	0,05	0,07	0,1	0,12	0,16	0,2
	50 - 20	0,04	0,06	0,08	0,1	0,12	0,16	0,2
	50 - 20	0,04	0,06	0,08	0,1	0,12	0,16	0,2
	50 - 20	0,04	0,06	0,08	0,1	0,12	0,16	0,2



117



**Bohrerschaft mit
Schneidplatte**

Formbreite 26 mm

**Boring Shank
with Insert**

Width of profile 26 mm

Bohrerschaft
Boring Shank
B117

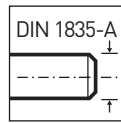

Seite/Page
49

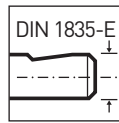

Seite/Page
50

Schneidplatte
Insert
D117

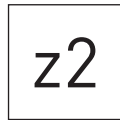

Seite/Page
51

Anzugsdrehmomente
Torque of Screws

Seite/Page
52

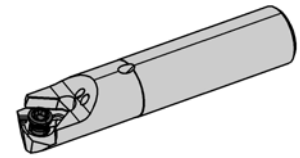
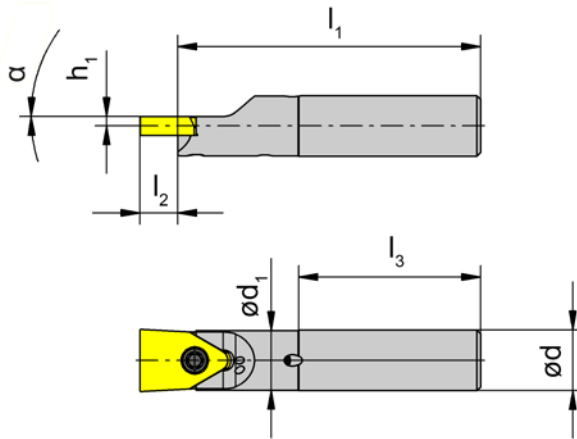
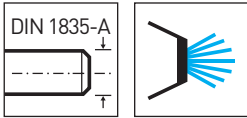

Bestellnummer Part number	d	l ₁	l ₂	d ₁	α	h ₁	l ₃	Schneidplatte Insert
B117.DD.16.3.A.16	16	80	10	15,8	0°	2,5	48	D117.0016.02.5.00
B117.DD.16.4.A.20	16	87	13	19,8	0°	2,5	47	D117.0020.02.5.00
B117.DD.20.5.A.26	20	95	14	25,8	0°	2,5	49	D117.0026.02.5.00
B117.DD.25.6.A.26	25	100	14	24,8	0°	2,5	56	D117.0026.02.5.00

Ersatzteile
Spare Parts

Bohrerschaft Boring Shank	Spannschraube Clamping Screw	TORX PLUS®-Schlüssel TORX PLUS® Wrench
B117.DD.16.3.A.16	5.10T20P	T20PQ
B117.DD...	6.17T20P	T20PQ

B

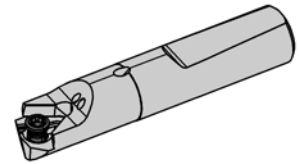
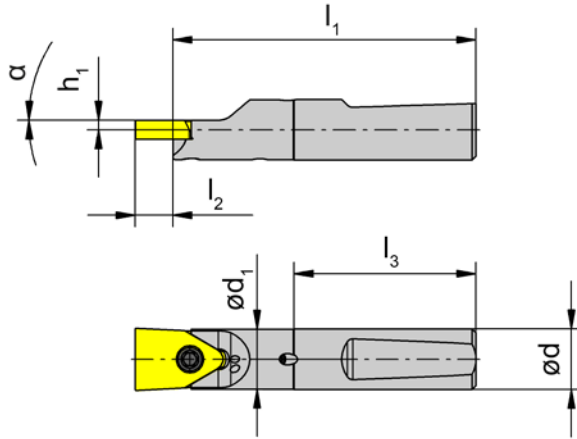
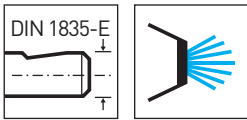

Bestellnummer Part number	d	l ₁	l ₂	d ₁	α	h ₁	l ₃	Schneidplatte Insert
B117.DD.16.3.E.16	16	80	10	15,8	0°	2,5	48	D117.0016.02.5.00
B117.DD.16.4.E.20	16	87	13	19,8	0°	2,5	47	D117.0020.02.5.00
B117.DD.20.5.E.26	20	95	14	25,8	0°	2,5	49	D117.0026.02.5.00
B117.DD.25.6.E.26	25	100	14	24,8	0°	2,5	56	D117.0026.02.5.00

Ersatzteile

Spare Parts

Bohrerschaft Boring Shank	Spannschraube Clamping Screw	TORX PLUS®-Schlüssel TORX PLUS® Wrench
B117.DD.16.3.E.16	5.10T20P	T20PQ
B117.DD...	6.17T20P	T20PQ

z2

B

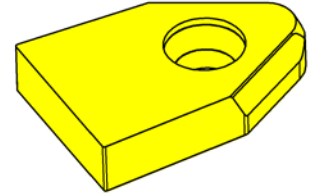
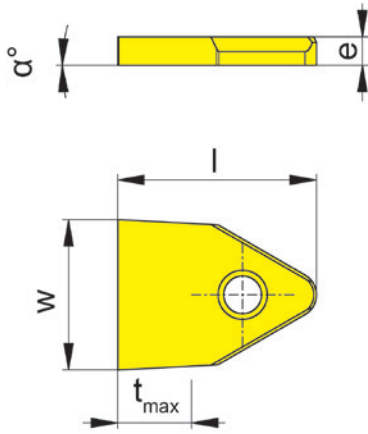

HM-Sorten
Carbide grades

▲ ab Lager
on stock

△ 4 Wochen
4 weeks

Bestellnummer Part number	w	E	t _{max}	l	α	Bohrerschaft Boring Shank	MG12
D117.0016.02.5.00	16	5	5	24	0°	B117.DD...16	▲
D117.0020.02.5.00	20	5	8	32	0°	B117.DD...20	▲
D117.0026.02.5.00	26	5	9	35	0°	B117.DD...26	▲

Die Schneidstoffsorte wird für jeden Anwendungsfall speziell ausgewählt und ist für die Werkstoffgruppen P, M, K und N verfügbar.

The cutting material is specially selected for each application and is available for the material groups P, M, K and N.

P	o
M	-
K	-
N	-
S	-
H	-

Nachstehende Drehmomente sind für die Spannschrauben zulässig. Wir empfehlen keine zusätzlichen Gleitmittel wie Kupferpaste oder ähnliches für die Schrauben zu verwenden.

Following torques are allowed for screws of inserts. We recommend to use no additional gliding means (such as copper paste) for screws.

Typ Type	Schraube Screw	M_d Nm	Schlüssel Clamping wrench	Klinge Blade
B117.DD.16.3.A.16	5.12T20P	6,0	T20PQ	DT20PK
B117.DD.16.4.A.20	6.17T20P	7,0	T20PQ	DT20PK
B117.DD.20.5.A.26	6.17T20P	7,0	T20PQ	DT20PK
B117.DD.25.6.A.26	6.17T20P	7,0	T20PQ	DT20PK
B117.DD.16.3.E.16	5.12T20P	6,0	T20PQ	DT20PK
B117.DD.16.4.E.20	6.17T20P	7,0	T20PQ	DT20PK
B117.DD.20.5.E.26	6.17T20P	7,0	T20PQ	DT20PK
B117.DD.25.6.E.26	6.17T20P	7,0	T20PQ	DT20PK

Profilierte Schneidplatten auf Anfrage

Profiled inserts upon request

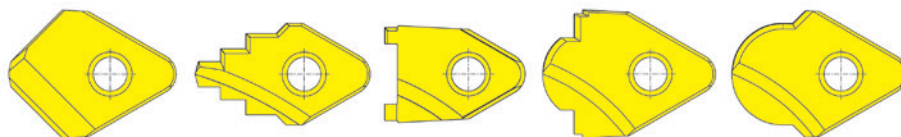

105

C

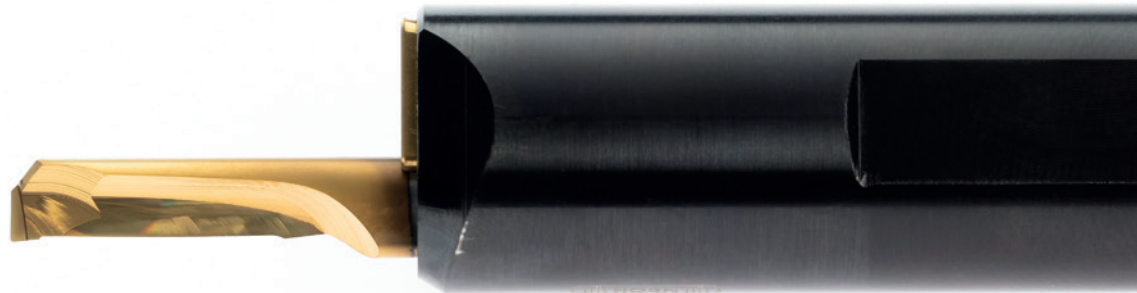

Supermini HP

Multifunktionelles Werkzeug
für hohe Schnitttiefen

Supermini HP

Multifunctional tool for
high cutting depths



Schneidplatte
Insert
105



Seite/Page
55



Seite/Page
56

Technische Hinweise
Technical Instructions

Seite/Page
57

Schnittdaten
Cutting data

Seite/Page
58

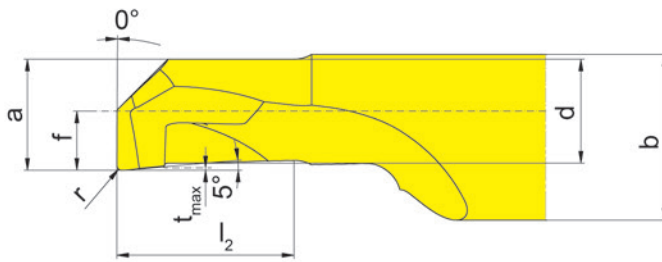
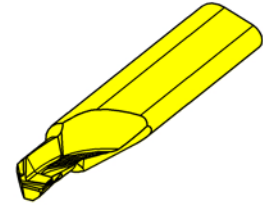
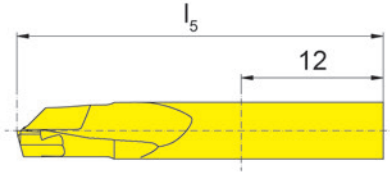
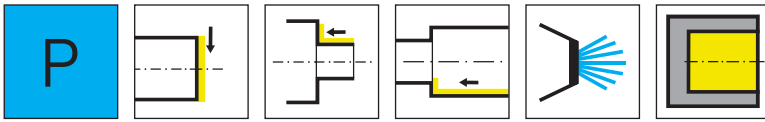

R = rechts wie gezeichnet
R = right hand version shown

L = links spiegelbildlich
L = left hand version

▲ ab Lager
on stock

HM-Sorten
Carbide grades
Δ 4 Wochen
4 weeks

Bestellnummer Part number	r	f	a	d	b	l ₂	l ₅	t _{max}	Ds	HIS	EG35
R105.BO.30.20.045.1	0,2	1,5	2,7	2,4	7	4,5	31	0,1	3	105125	▲
R105.BO.30.20.075.1	0,2	1,5	2,7	2,4	7	7,5	31	0,1	3	105125	▲
R105.BO.40.20.060.1	0,2	2	3,7	3,4	7	6	31	0,1	4	105125	▲
R105.BO.40.20.100.1	0,2	2	3,7	3,4	7	10	31	0,1	4	105125	▲
R105.BO.50.20.075.1	0,2	2,5	4,7	4,4	7	7,5	31	0,1	5	105125	▲
R105.BO.50.20.125.1	0,2	2,5	4,7	4,4	7	12,5	36	0,1	5	105125	▲
R105.BO.60.20.090.1	0,2	3	5,4	5,1	7	9	31	0,1	6	105125	▲
R105.BO.60.20.150.1	0,2	3	5,4	5,1	7	15	36	0,1	6	105125	▲
R105.BO.70.20.105.1	0,2	3,5	5,9	5,6	7	10,5	36	0,1	7	105125	▲
R105.BO.70.20.175.1	0,2	3,5	5,9	5,6	7	17,5	40	0,1	7	105125	▲
L105.BO.30.20.045.1	0,2	1,5	2,7	2,4	7	4,5	31	0,1	3	105125	Δ
L105.BO.30.20.075.1	0,2	1,5	2,7	2,4	7	7,5	31	0,1	3	105125	Δ
L105.BO.40.20.060.1	0,2	2	3,7	3,4	7	6	31	0,1	4	105125	Δ
L105.BO.40.20.100.1	0,2	2	3,7	3,4	7	10	31	0,1	4	105125	Δ
L105.BO.50.20.075.1	0,2	2,5	4,7	4,4	7	7,5	31	0,1	5	105125	Δ
L105.BO.50.20.125.1	0,2	2,5	4,7	4,4	7	12,5	36	0,1	5	105125	Δ
L105.BO.60.20.090.1	0,2	3	5,4	5,1	7	9	31	0,1	6	105125	Δ
L105.BO.60.20.150.1	0,2	3	5,4	5,1	7	15	36	0,1	6	105125	Δ
L105.BO.70.20.105.1	0,2	3,5	5,9	5,6	7	10,5	36	0,1	7	105125	Δ
L105.BO.70.20.175.1	0,2	3,5	5,9	5,6	7	17,5	40	0,1	7	105125	Δ

mit innerer Kühlmittelzufuhr ab Schneidkreisdurchmesser 5 mm
with through coolant supply from cutting diameter 5 mm

P	●
M	●
K	○
N	-
S	-
H	-

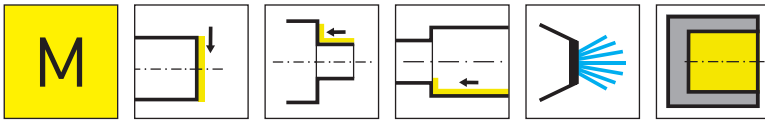

C

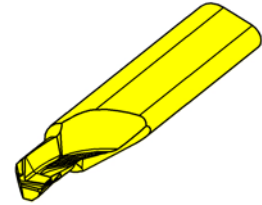
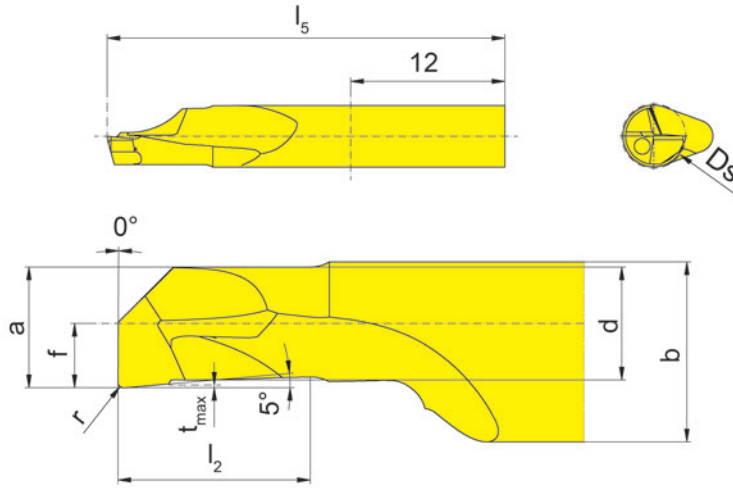

R = rechts wie gezeichnet
R = right hand version shown

L = links spiegelbildlich
L = left hand version

▲ ab Lager
on stock

HM-Sorten
Carbide grades
Δ 4 Wochen
4 weeks

Bestellnummer Part number	r	f	a	d	b	l ₂	l ₅	t _{max}	Ds	HIS	EG35
R105.BO.30.20.045.2	0,2	1,5	2,7	2,4	7	4,5	31	0,1	3	105125	▲
R105.BO.30.20.075.2	0,2	1,5	2,7	2,4	7	7,5	31	0,1	3	105125	▲
R105.BO.40.20.060.2	0,2	2	3,7	3,4	7	6	31	0,1	4	105125	▲
R105.BO.40.20.100.2	0,2	2	3,7	3,4	7	10	31	0,1	4	105125	▲
R105.BO.50.20.075.2	0,2	2,5	4,7	4,4	7	7,5	31	0,1	5	105125	▲
R105.BO.50.20.125.2	0,2	2,5	4,7	4,4	7	12,5	36	0,1	5	105125	▲
R105.BO.60.20.090.2	0,2	3	5,4	5,1	7	9	31	0,1	6	105125	▲
R105.BO.60.20.150.2	0,2	3	5,4	5,1	7	15	36	0,1	6	105125	▲
R105.BO.70.20.105.2	0,2	3,5	5,9	5,6	7	10,5	36	0,1	7	105125	▲
R105.BO.70.20.175.2	0,2	3,5	5,9	5,6	7	17,5	40	0,1	7	105125	▲
L105.BO.30.20.045.2	0,2	1,5	2,7	2,4	7	4,5	31	0,1	3	105125	Δ
L105.BO.30.20.075.2	0,2	1,5	2,7	2,4	7	7,5	31	0,1	3	105125	Δ
L105.BO.40.20.060.2	0,2	2	3,7	3,4	7	6	31	0,1	4	105125	Δ
L105.BO.40.20.100.2	0,2	2	3,7	3,4	7	10	31	0,1	4	105125	Δ
L105.BO.50.20.075.2	0,2	2,5	4,7	4,4	7	7,5	31	0,1	5	105125	Δ
L105.BO.50.20.125.2	0,2	2,5	4,7	4,4	7	12,5	36	0,1	5	105125	Δ
L105.BO.60.20.090.2	0,2	3	5,4	5,1	7	9	31	0,1	6	105125	Δ
L105.BO.60.20.150.2	0,2	3	5,4	5,1	7	15	36	0,1	6	105125	Δ
L105.BO.70.20.105.2	0,2	3,5	5,9	5,6	7	10,5	36	0,1	7	105125	Δ
L105.BO.70.20.175.2	0,2	3,5	5,9	5,6	7	17,5	40	0,1	7	105125	Δ

mit innerer Kühlmittelzufuhr ab Schneidkreisdurchmesser 5 mm
with through coolant supply from cutting diameter 5 mm

P	●
M	●
K	○
N	-
S	-
H	-

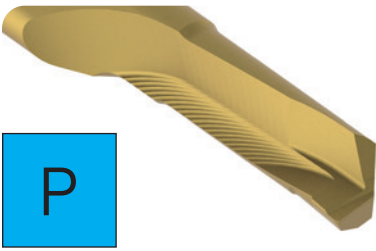

R/L105.BO...1

Geometrie mit Spantreppe (für Stahl)

- Ausdrehen mit großen Zustellungen
- Für allgemeine Stähle
- Mit Schleppschneide für höhere Vorschübe
- Bessere Spankontrolle
- Bohren in allgemeinen Stählen
- Bei problematischen Anwendungen mit dem Ziel Prozesssicherheit
- Auch bei langspanenden Werkstoffen

Geometry with chipbreaker (steel materials)

- Turning with large infeeds
- For general steels
- With trailing cutting edge for higher feeds
- Better chip control
- Drilling in general steels
- For problematic applications with the aim of process reliability
- Also for long-chipping materials

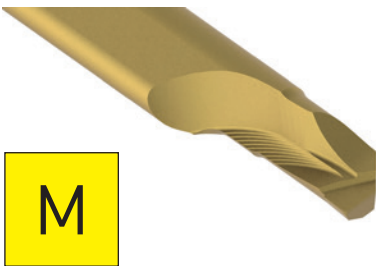

R/L105.BO...2

Universalgeometrie (für rostfreien Stahl)

- Ausdrehen mit großen Zustellungen
- Leichtschneidende Universalgeometrie auch für rostfreie Stähle
- Mit Schleppschneide für höhere Vorschübe
- Weniger Schnittdruck, auch für dünnwandige Bauteile
- Zum Bohren in Stahl und NE-Metallen

Universal geometry (for stainless steels)

- Turning with large infeeds
- Easy cutting universal geometry also for stainless steels
- With trailing cutting edge for higher feeds
- Less cutting pressure, suitable even for thin-walled components
- For drilling in steel and non-ferrous metals

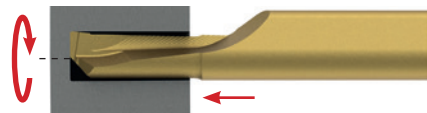

Bohren ins Volle mit ebenem Bohrungsgrund
 Drilling into the solid and achieving a flat hole bottom

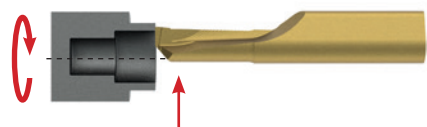

Drehen von Plankonturen
 Turning of face profiles

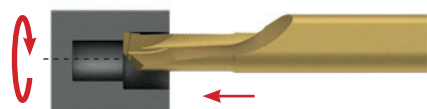

Drehen von Innenkonturen
 Turning of internal profiles

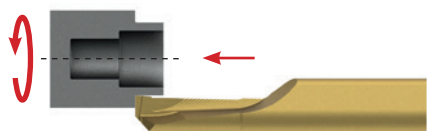

Drehen von Außenkonturen
 Turning of external profiles





Ausdrehen Stahl Boring Steel		Schnitttiefe ap (mm) Depth of cut ap (mm)					
		0,5	1	1,5	2	2,5	3
		Vorschub f [mm/U] Feed rate f [mm/rev]					
R/L105.BO.30.20.045.1	1,5*D	0,03-0,05	0,02-0,03				
R/L105.BO.30.20.075.1	2,5*D	0,03-0,05	0,02-0,03				
R/L105.BO.40.20.060.1	1,5*D	0,04-0,06	0,04-0,06	0,04-0,06			
R/L105.BO.40.20.100.1	2,5*D	0,04-0,06	0,04-0,06	0,04-0,06			
R/L105.BO.50.20.075.1	1,5*D	0,05-0,08	0,05-0,08	0,04-0,07	0,04-0,07		
R/L105.BO.50.20.125.1	2,5*D	0,05-0,08	0,05-0,08	0,04-0,07	0,04-0,07		
R/L105.BO.60.20.090.1	1,5*D	0,07-0,1	0,07-0,1	0,07-0,1	0,07-0,1	0,05-0,08	
R/L105.BO.60.20.150.1	2,5*D	0,07-0,1	0,07-0,1	0,07-0,1	0,07-0,1	0,05-0,08	
R/L105.BO.70.20.105.1	1,5*D	0,08-0,1	0,07-0,1	0,07-0,1	0,07-0,1	0,07-0,08	0,05-0,07
R/L105.BO.70.20.175.1	2,5*D	0,08-0,1	0,07-0,1	0,07-0,1	0,07-0,1	0,07-0,08	0,05-0,07

Vorschubwerte für rostfreie Materialien: Minimal-Werte wählen.
Feed rates for stainless materials: Select minimum values.

Bohren Stahl Drilling Steel		Vorschub f [mm/U] Feed rate f [mm/rev]
R/L105.BO.30.20.045.2	1,5*D	0,01-0,02
R/L105.BO.30.20.075.2	2,5*D	0,01-0,02
R/L105.BO.40.20.060.2	1,5*D	0,01-0,02
R/L105.BO.40.20.100.2	2,5*D	0,01-0,02
R/L105.BO.50.20.075.2	1,5*D	0,02-0,04
R/L105.BO.50.20.125.2	2,5*D	0,02-0,04
R/L105.BO.60.20.090.2	1,5*D	0,03-0,05
R/L105.BO.60.20.150.2	2,5*D	0,03-0,05
R/L105.BO.70.20.105.2	1,5*D	0,03-0,05
R/L105.BO.70.20.175.2	2,5*D	0,03-0,05

Zum Bohren empfehlen wir die Universalgeometrie
For drilling we recommend the universal geometry

B05



Ausspindeln

mit URMA Feinbohrkopf 05
und System Supermini

Boring

with URMA Fine Boring Head 05
and System Supermini

Übersicht
Overview

Seite/Page
61

Technische Hinweise
Technical Instructions

Seite/Page
62-63

Feinbohrkopf
Fine Boring Head
B05

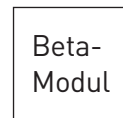

Seite/Page
64

Klemmhalter
Toolholder
B105/B110

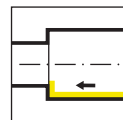

Seite/Page
65-67

Schneidplatte
Insert
105/110

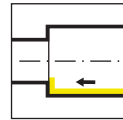

Seite/Page
68, 76

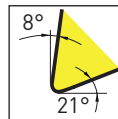

Seite/Page
69-73, 77

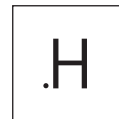

Seite/Page
74

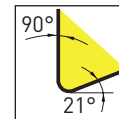

Seite/Page
75

Aufnahme mit Beta-Modul 40 siehe Kapitel URMA Systemaufnahmen
Adaptor with Beta-Module 40 see Chapter System Adaptors URMA

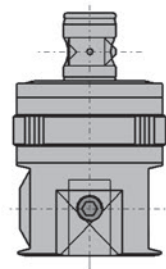
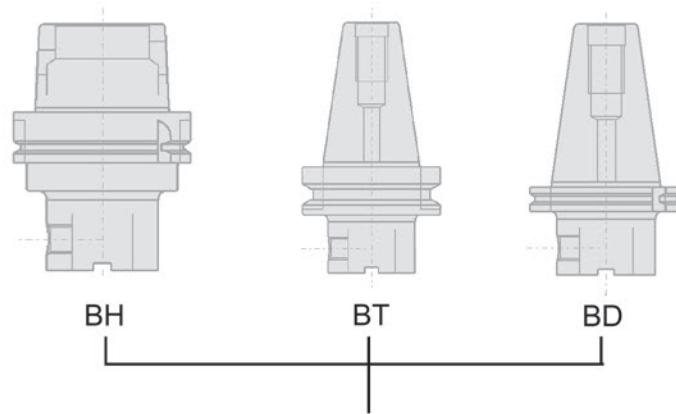

Feinbohrkopf 05
Fine Boring head 05

Klemmhalter Rechtslauf
Toolholder right-hand rotation

Klemmhalter Linkslauf
Toolholder left-hand rotation

Sonderlösungen
Special solutions

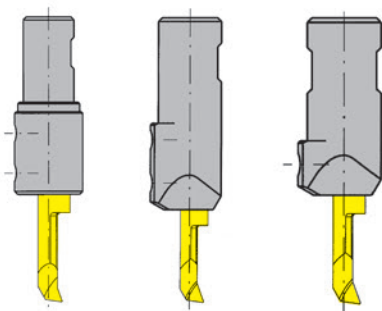

B110 B105 B105

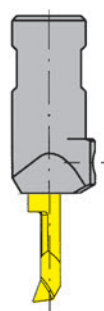

B105 $< \varnothing 1 \text{ mm}$

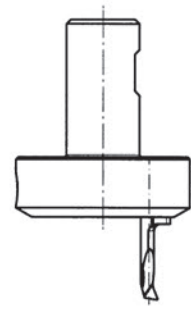

Rechte Schneidplatten
Right-hand inserts

Linke Schneidplatten
Left-hand inserts



Ausspindeln mit Feinbohrkopf URMA 05

Boring with fine Boring head URMA 05

D

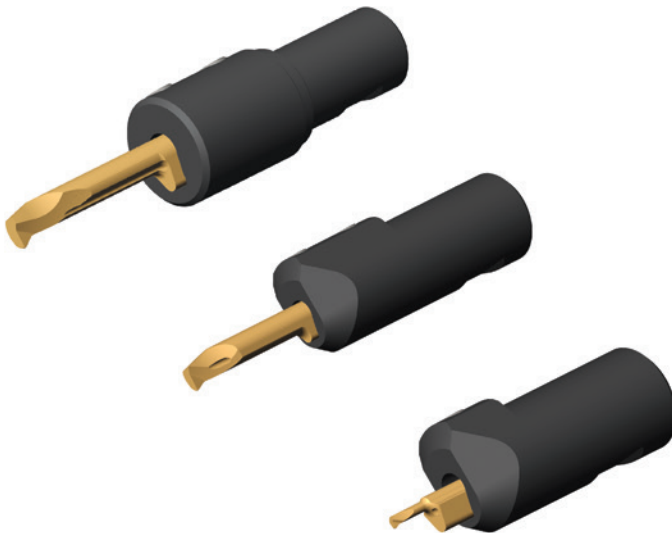

ab Ø 0,2 mm
mit Schneidplatte Typ 105
oder
ab Ø 6,0 mm
mit Schneidplatte Typ 110

from Ø 0,2 mm
with insert type 105
or
from Ø 6,0 mm
with insert type 110



CBN und Diamant bestückte Schneidplatten
für Bohrungen ab Ø2 mm verfügbar.

Siehe Katalog
HOCHHARTE SCHNEIDSTOFFE
-DREHEN-

PCBN and Diamont tipped inserts available
for bores from a diameter of 2 mm

Please see catalogue
ULTRA HARD CUTTING MATERIALS
-TURNING-

Wir empfehlen grundsätzlich Schneiden in rechter Ausführung zu verwenden, damit im Rechtslauf gearbeitet werden kann. Eine Ausnahme wird bei kleinen Durchmessern, zumeist $< \varnothing 1$ mm, teilweise darüberliegend erforderlich. Der Klemmhalter B105 muss um 180° gedreht werden, damit die Supermini Schneidplatte hinter der Drehmitte verstellt werden kann.

Formel für zu verwendende Schneidplatte Typ 105:

Wenn $f \times 2 > D_{\min}$ bzw. D , dann Schneide in linker Ausführung verwenden.

We always recommend using right-hand inserts so that you can work in clockwise rotation. An exception is necessary for small diameters up to approx. 1 mm. The toolholder B105 must be turned by 180° so that the Supermini insert can be adjusted behind the centre of rotation.

Formula for insert type 105 to be used:

If $f \times 2 > D_{\min}$ or D , then use insert in left-hand version.

Bestellnummer Part number	r	f	a	b	l_2	l_5	t_{\max}	D_{\min}	Form
L105.1802.0.03	0,02	1	0,25	5,9	1	23	0,02	0,3	B

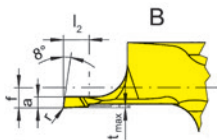

$$D_{\min} 0,3 \text{ mm} < 2xf$$

= linke Ausführung / = left hand version

Bestellnummer Part number	r	f	a	b	l_2	l_5	t_{\max}	D_{\min}	Form
R105.1803.0.07	0,05	0,3	0,6	5,9	2	23	0,05	0,7	B

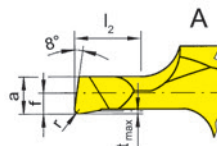

$$D_{\min} 0,7 \text{ mm} > 2xf$$

= rechte Ausführung / = right hand version

Einbaulage des Halters

Mounting position of of holder



normal (rechte Schneidplatte)
normal (right hand insert)



180° gedreht (rechte Schneidplatte)
 180° rotated (right hand insert)

Feinbohrkopf Fine Boring Head

B05

$\varnothing > 0,2 \text{ mm}$

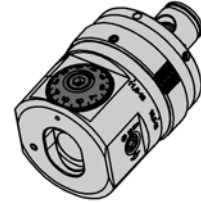
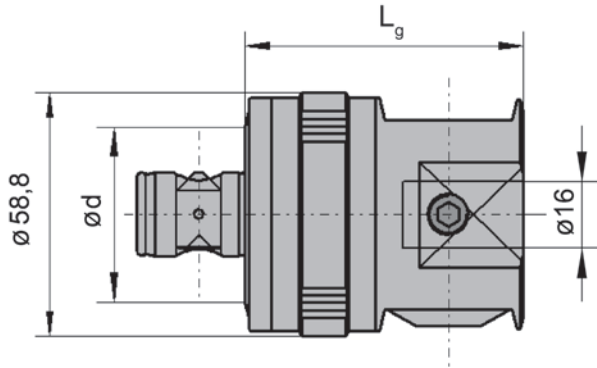
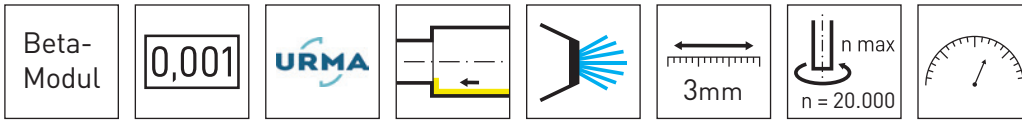

D

Bestellnummer Part number	Lg	d	Beta-Modul	Gewicht [kg] Weight [kg]
B05.40.30.067	67	42	40	1,3
B05.40.30.067-D	67	42	40	1,3

Skalaeinteilung / scale marking

B05.40.30.067: analog = 0,01

B05.40.30.067-D: analog = 0,01 / digital = 0,001

Digitales Anzeigergerät zur Anzeige des Verstellbereichs
Digital display unit to show the adjusting range

Zubehör für B05...-D:

Digitales Anzeigergerät

Additional equipment for B05...-D:

Digital display

Bestellnummer Part number	l	b	h	Gewicht [kg] Weight [kg]
92.00.25-D	120	80	25	0,18



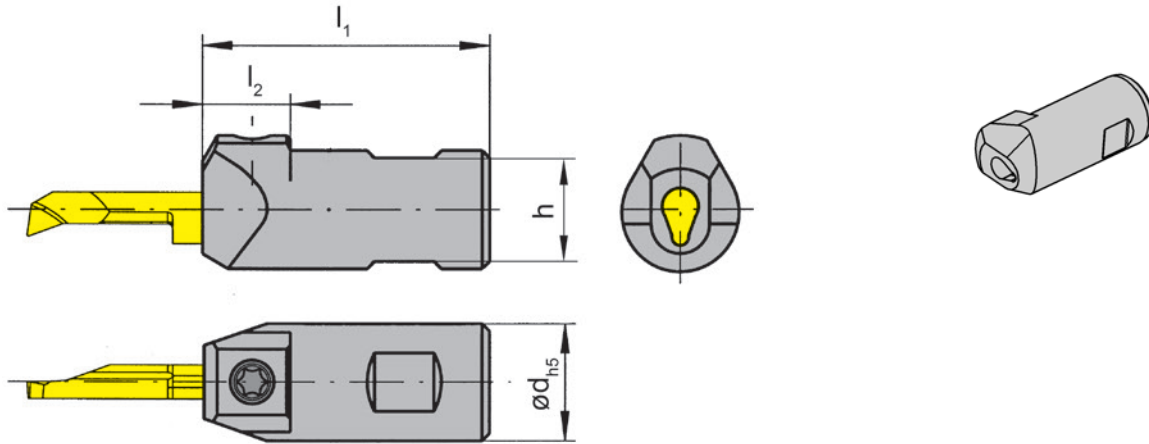
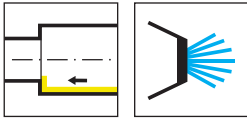

Bestellnummer Part number	l_1	l_2	d	h	HWS
B105.0016.U1.01	39	12	16	14	105123 • 105124 • 105125

Durch die doppelseitige Spannfläche kann der Klemmhalter im Feinbohrkopf um 180° gedreht werden, somit ist ein Verstellen hinter Mitte für Bohrungen kleiner $\varnothing 0,7 \text{ mm}$ realisierbar.

The double sided clamping surface allows to rotate the toolholder in the boring head of 180°. With this option it is possible to set the insert behind centre which is necessary for diameters less than $\varnothing 0,7 \text{ mm}$.

Spannlänge 12 mm
Clamping length 12 mm

Ersatzteile
Spare Parts

Klemmhalter Toolholder	Spannschraube Clamping Screw	TORX PLUS®-Schlüssel TORX PLUS® Wrench
B105.0016.U1.01	6.075T15P	T15PQ



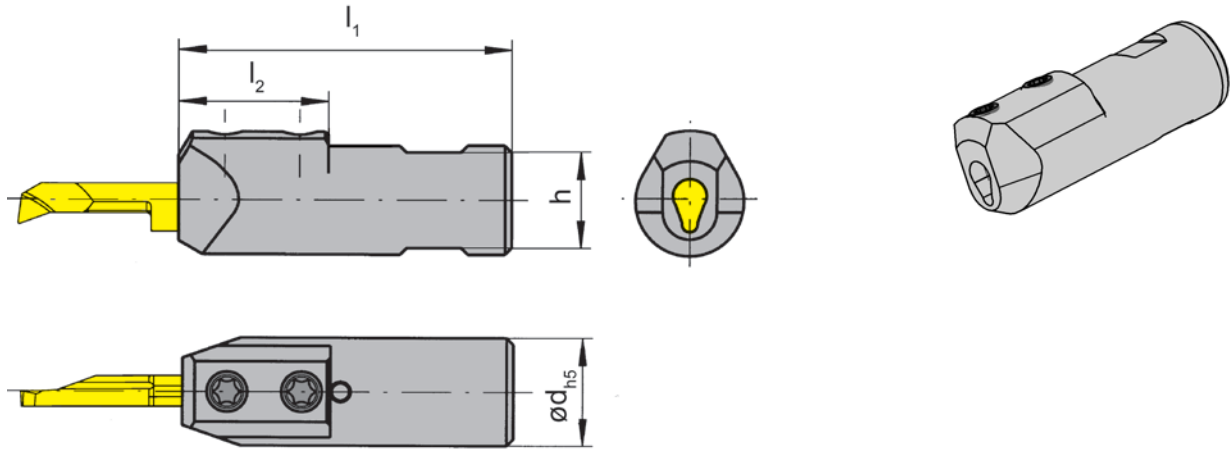
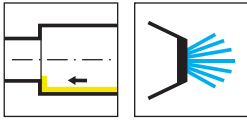

D

Bestellnummer Part number	l_1	l_2	d	h	HWS
B105.0016.U1.02	49	22	16	14	105225

Spannlänge 22 mm
Clamping length 22 mm

Ersatzteile
Spare Parts

Klemmhalter Toolholder	Spannschraube Clamping Screw	TORX PLUS®-Schlüssel TORX PLUS® Wrench
B105.0016.U1.02	6.075T15P	T15PQ

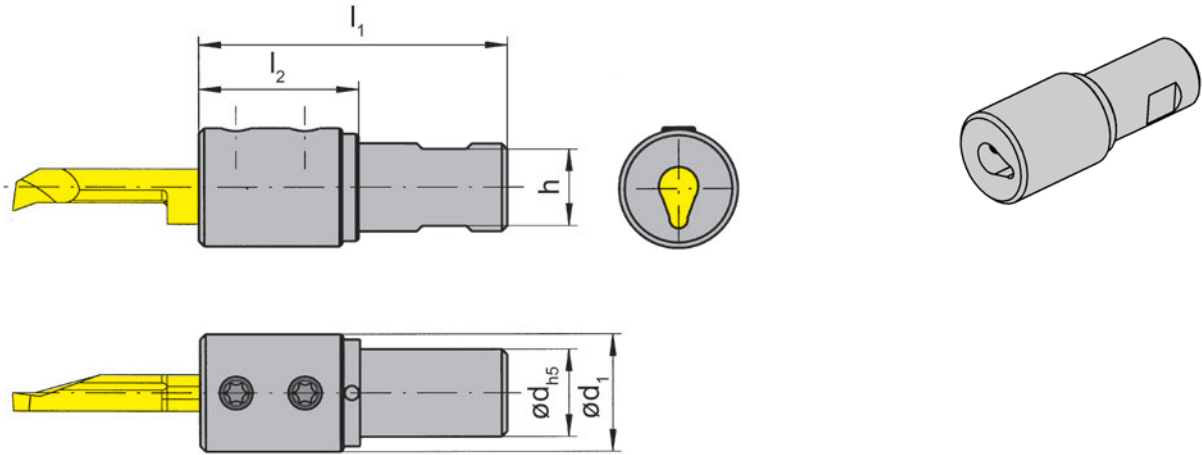
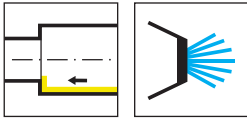

Bestellnummer Part number	l_1	l_2	d	d_1	h	HWS
B110.0016.U1.02	56	29	16	21,5	14	110260

Spannlänge 26 mm
Clamping length 26 mm

Ersatzteile
Spare Parts

Klemmhalter Toolholder	Spannschraube Clamping Screw	TORX PLUS®-Schlüssel TORX PLUS® Wrench
B110.0016.U1.02	6.075T15P	T15PQ



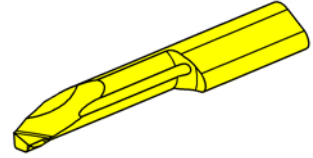
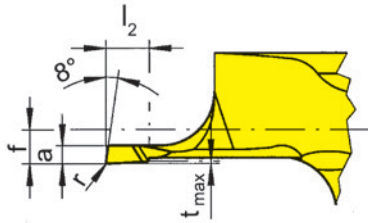
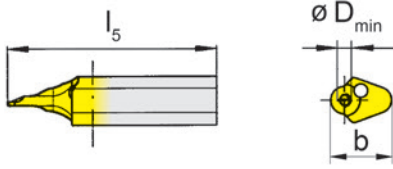
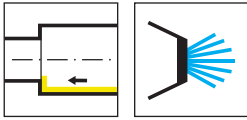

D

L = links wie gezeichnet
L = left hand version shown

HM-Sorten
Carbide grades
▲ ab Lager
on stock
Δ 4 Wochen
4 weeks

Bestellnummer Part number	r	f	a	b	l ₂	l ₅	t _{max}	D _{min}	Form	HIS	EG35
L105.1802.0.02	0,02	1	0,17	5,9	1	23	0,02	0,2	B	105123	Δ
L105.1802.0.03	0,02	1	0,25	5,9	1	23	0,02	0,3	B	105123	Δ
L105.1802.0.05	0,05	1	0,4	5,9	2	23	0,05	0,5	B	105123	Δ

Bohrungsdurchmesser von 0,2 - 1 mm linke Schneidplatten verwenden.

Der Klemmhalter B105.0016.U1.01 muss um 180° gedreht eingebaut werden - siehe technische Hinweise.

Bore diameter 0,2 - 1 mm left hand insert used.

Toolholder B105.0016.U1.01 must be installed rotated by 180° - see technical notes.

P	●
M	●
K	○
N	-
S	-
H	-

Schneidplatte Insert

105

Ø > 1 mm

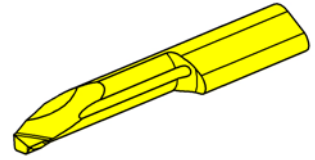
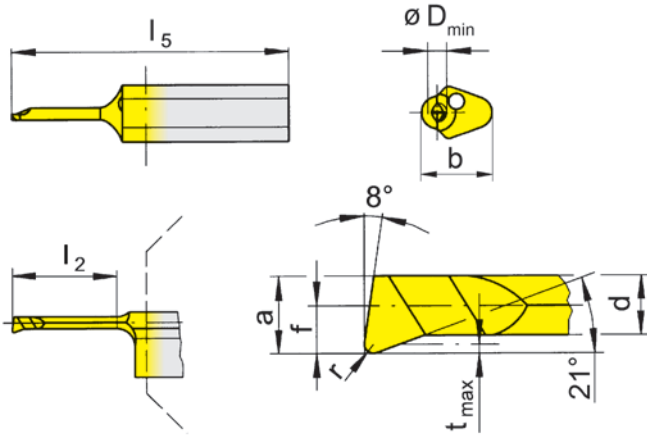
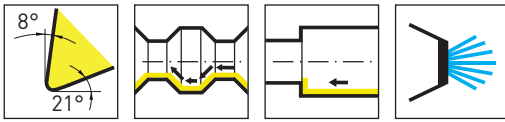

R = rechts wie gezeichnet
R = right hand version shown

▲ ab Lager
on stock

HM-Sorten
Carbide grades

Δ 4 Wochen
4 weeks

Bestellnummer Part number	r	f	a	d	b	l ₂	l ₅	t _{max}	D _{min}	HIS	EG35	IG35	TH35	TI25	TN35
R105.1805.005.0.1	0,05	0,5	0,9	0,65	5,9	4	25	0,1	1	105123	▲	▲	▲		
R105.1805.005.2.1	0,05	0,5	0,9	0,65	5,9	8	25	0,1	1	105123	Δ	▲	▲		
R105.1805.0.1	0,1	0,5	0,9	0,65	5,9	4	25	0,1	1	105123	▲	▲		▲	▲
R105.1805.1.1	0,1	0,5	0,9	0,65	5,9	6	25	0,1	1	105123	▲	▲		▲	▲
R105.1805.2.1	0,1	0,5	0,9	0,65	5,9	8	25	0,1	1	105123	▲	▲		▲	▲
R105.1813.005.0.15	0,05	1,3	1,4	1,1	5,9	6	25	0,15	1,5	105123	▲	▲	▲		
R105.1813.005.1.15	0,05	1,3	1,4	1,1	5,9	9	25	0,15	1,5	105123	▲	▲	▲		
R105.1813.005.2.15	0,05	1,3	1,4	1,1	5,9	12	30	0,15	1,5	105123	▲	▲	▲		
R105.1813.01.0.15	0,1	1,3	1,4	1,1	5,9	6	25	0,15	1,5	105123	▲	▲	▲	▲	
R105.1813.01.1.15	0,1	1,3	1,4	1,1	5,9	9	25	0,15	1,5	105123	▲	▲	▲	▲	
R105.1813.01.2.15	0,1	1,3	1,4	1,1	5,9	12	30	0,15	1,5	105123	▲	▲	▲	▲	

Ab Bohrungsdurchmesser 1 mm rechte Schneidplatten verwenden.
Der Klemmhalter B105.0016.U1.01 muss auf Lage 0° eingebaut werden – siehe technische Hinweise.
Bore diameter from 1 mm right-hand inserts used.
Toolholder B105.0016.U1.01 must be installed at position 0° - see technical instructions.

P	o	●	-	●	●	●
M	-	●	●	●	●	●
K	-	o	-	●	●	●
N	-	-	-	●	●	●
S	-	-	●	●	●	●
H	-	-	-	-	-	-



Schneidplatte Insert

105

Ø > 2 mm

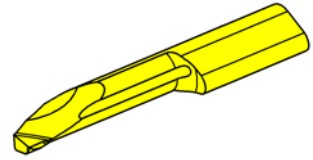
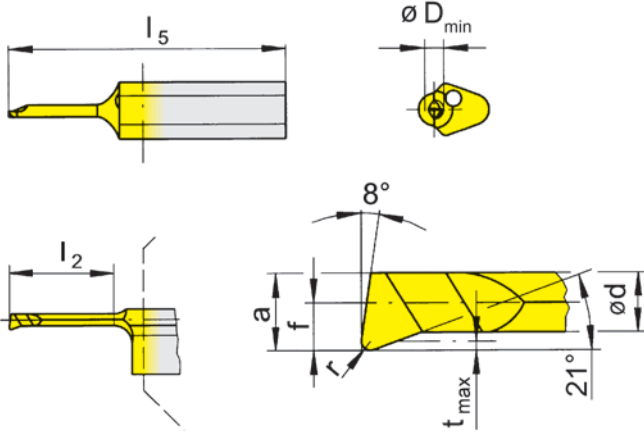
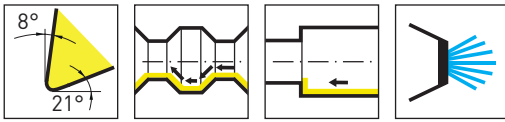

D

R = rechts wie gezeichnet
R = right hand version shown

▲ ab Lager
on stock

HM-Sorten
Carbide grades

△ 4 Wochen
4 weeks

Bestellnummer Part number	r	f	a	d	b	l ₂	l ₅	t _{max}	D _{min}	HIS	EG35	IG35	TH35	TI25	TN35
R105.1809.005.0.2	0,05	1	1,9	1,6	5,9	6	25	0,15	2	105123	▲	▲	▲	△	△
R105.1809.005.1.2	0,05	1	1,9	1,6	5,9	9	25	0,15	2	105123	▲	▲	▲	△	△
R105.1809.005.2.2	0,05	1	1,9	1,6	5,9	12	30	0,15	2	105123	▲	▲	▲	△	△
R105.1809.01.0.2	0,1	1	1,9	1,6	5,9	6	25	0,15	2	105123	△	▲	▲	▲	
R105.1809.01.1.2	0,1	1	1,9	1,6	5,9	9	25	0,15	2	105123	▲	▲	▲	▲	
R105.1809.01.2.2	0,1	1	1,9	1,6	5,9	12	30	0,15	2	105123	△	▲	▲	▲	
R105.1813.005.0.25	0,05	1,3	2,3	1,95	5,9	6	25	0,15	2,5	105123	▲	▲	▲		
R105.1813.005.2.25	0,05	1,3	2,3	1,95	5,9	12	30	0,15	2,5	105123	△	▲	▲		
R105.1813.005.3.25	0,05	1,3	2,3	1,95	5,9	16	35	0,15	2,5	105123	▲	▲	▲		

Ab Bohrungsdurchmesser 1 mm rechte Schneidplatten verwenden.
Der Klemmhalter B105.0016.U1.01 muss auf Lage 0° eingebaut werden - siehe technische Hinweise.

Bore diameter from 1 mm right-hand inserts used.
Toolholder B105.0016.U1.01 must be installed at position 0° - see technical instructions.

P	●	-	●	●	●
M	●	●	●	●	●
K	○	-	●	●	●
N	-	-	●	●	●
S	-	●	●	●	●
H	-	-	-	-	-

Schneidplatte Insert

105

Ø > 3 mm

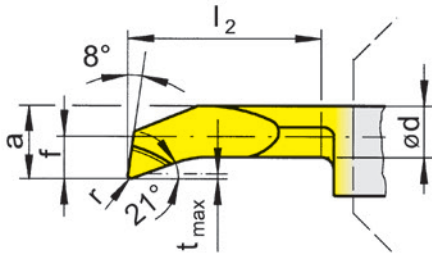
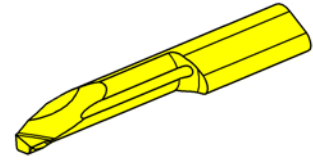
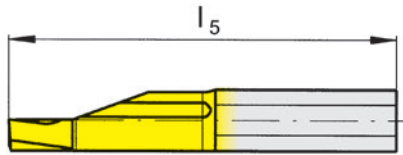
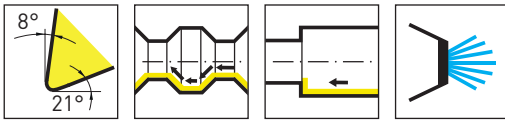

R = rechts wie gezeichnet
R = right hand version shown

▲ ab Lager
on stock

HM-Sorten
Carbide grades
Δ 4 Wochen
4 weeks

Bestellnummer Part number	r	f	a	d	b	l ₂	l ₅	t _{max}	D _{min}	HIS	EG35	IG35	TH35	TI25	TN35
R105.1813.005.1.3	0,05	1,3	2,6	2,3	5,9	10	25	0,15	3	105123	▲	▲	▲	Δ	Δ
R105.1813.005.2.3	0,05	1,3	2,6	2,3	5,9	15	30	0,15	3	105123	Δ	▲	▲	▲	Δ
R105.1813.005.3.3	0,05	1,3	2,6	2,3	5,9	20	35	0,15	3	105123	▲	▲	▲	Δ	
R105.1813.01.1.3	0,1	1,3	2,6	2,3	5,9	10	25	0,15	3	105123	▲	▲	▲	▲	
R105.1813.01.2.3	0,1	1,3	2,6	2,3	5,9	15	30	0,15	3	105123	▲	▲	▲	▲	
R105.1813.01.3.3	0,1	1,3	2,6	2,3	5,9	20	35	0,15	3	105123	▲	▲	▲	▲	
R105.1819.005.1.4	0,05	1,9	3,7	2,9	6,4	10	25	0,3	4	105124	▲	▲	▲	Δ	
R105.1819.005.2.4	0,05	1,9	3,7	2,9	6,4	15	30	0,3	4	105124	▲	▲	▲		
R105.1819.005.3.4	0,05	1,9	3,7	2,9	6,4	20	35	0,3	4	105124	▲	▲	▲		
											P	●	-	●	●
											M	●	●	●	●
											K	○	-	●	●
											N	-	-	●	●
											S	-	●	●	●
											H	-	-	-	-

Ab Bohrungsdurchmesser 1 mm rechte Schneidplatten verwenden.
Der Klemmhalter B105.0016.U1.01 muss auf Lage 0° eingebaut werden - siehe technische Hinweise.
Bore diameter from 1 mm right-hand inserts used.
Toolholder B105.0016.U1.01 must be installed at position 0° - see technical instructions.



Schneidplatte Insert

105

Ø > 5 mm

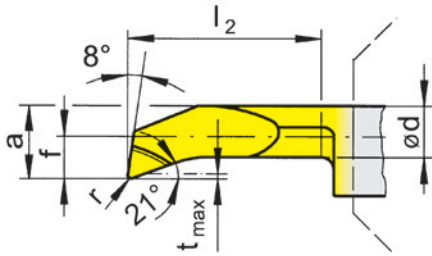
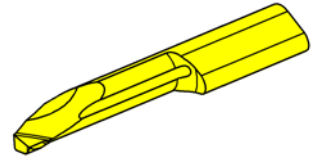
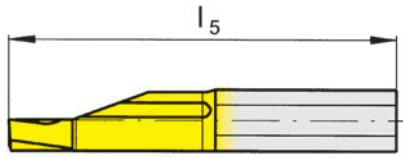
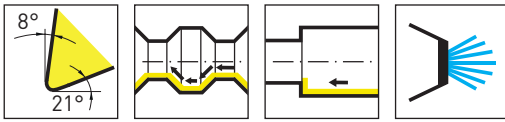

D

R = rechts wie gezeichnet
R = right hand version shown

▲ ab Lager
on stock

HM-Sorten
Carbide grades
Δ 4 Wochen
4 weeks

Bestellnummer Part number	r	f	a	d	b	l ₂	l ₅	t _{max}	D _{min}	HIS	EG35	IG35	TH35	TI25	TN35
R105.1823.005.1.5	0,05	2,3	4,7	4	7	10	25	0,5	5	105125	▲	▲	▲		
R105.1823.005.2.5	0,05	2,3	4,7	4	7	15	30	0,5	5	105125	▲	▲	▲		Δ
R105.1823.005.3.5	0,05	2,3	4,7	4	7	20	35	0,5	5	105125	▲	▲	▲		Δ
R105.1823.005.4.5	0,05	2,3	4,7	4	7	25	40	0,5	5	105125	▲	▲	▲		Δ
R105.1823.005.5.5	0,05	2,3	4,7	4	7	30	45	0,5	5	105125	▲	▲	▲		
											P	●	-	●	●
											M	●	●	●	●
											K	○	-	●	●
											N	-	-	●	●
											S	-	●	●	●
											H	-	-	-	-

Ab Bohrungsdurchmesser 1 mm rechte Schneidplatten verwenden.
Der Klemmhalter B105.0016.U1.01 muss auf Lage 0° eingebaut werden - siehe technische Hinweise.
Bore diameter from 1 mm right-hand inserts used.
Toolholder B105.0016.U1.01 must be installed at position 0° - see technical instructions.

Schneidplatte Insert

105

Ø > 6 mm

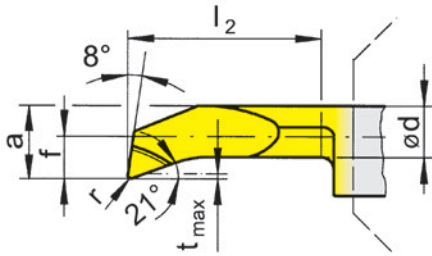
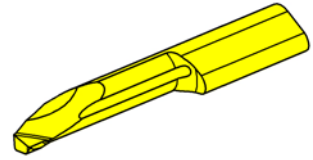
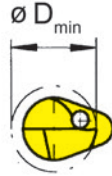
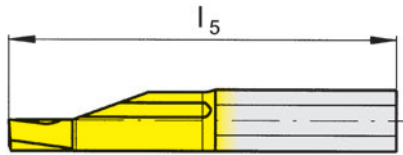
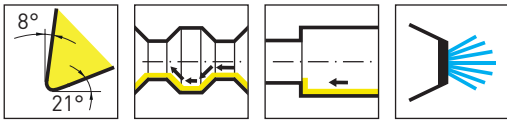

R = rechts wie gezeichnet
R = right hand version shown

▲ ab Lager
on stock

HM-Sorten
Carbide grades
Δ 4 Wochen
4 weeks

Bestellnummer Part number	r	f	a	d	b	l ₂	l ₅	t _{max}	D _{min}	HIS	EG35	IG35	TH35	TN35
R105.1833.005.2.6	0,05	3,3	5,7	4,7	7	15	30	0,5	6	105125	▲	▲	▲	
R105.1833.005.3.6	0,05	3,3	5,7	4,7	7	20	35	0,5	6	105125	Δ	▲	▲	
R105.1833.005.4.6	0,05	3,3	5,7	4,7	7	25	40	0,5	6	105125	Δ	▲	▲	
R105.1833.005.5.6	0,05	3,3	5,7	4,7	7	30	45	0,5	6	105125	Δ	▲		Δ
P	●	-	●	●							●	-	●	●
M	●	●	●	●							●	●	●	●
K	○	-	●	●							○	-	●	●
N	-	-	●	●							-	-	●	●
S	-	●	●	●							-	●	●	●
H	-	-	-	-							-	-	-	-

Ab Bohrungsdurchmesser 1 mm rechte Schneidplatten verwenden.
Der Klemmhalter B105.0016.U1.01 muss auf Lage 0° eingebaut werden - siehe technische Hinweise.
Bore diameter from 1 mm right-hand inserts used.
Toolholder B105.0016.U1.01 must be installed at position 0° - see technical instructions.



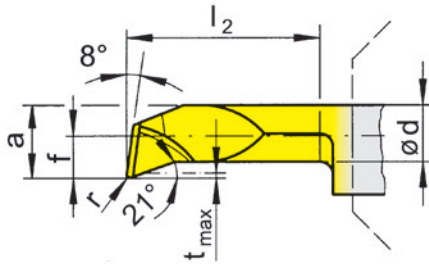
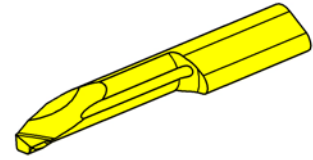
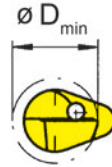
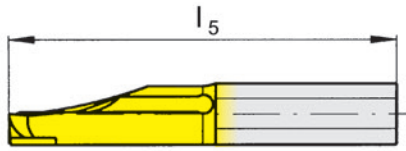
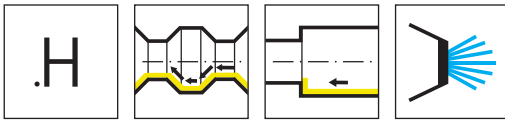

D

R = rechts wie gezeichnet
R = right hand version shown

▲ ab Lager
on stock

HM-Sorten
Carbide grades
Δ 4 Wochen
4 weeks

Bestellnummer Part number	r	f	a	d	b	l ₂	l ₅	t _{max}	D _{min}	HIS	EG35	TH35
R105.1819.2.H.4	0,2	1,9	3,7	2,9	7	15	30	0,3	4	105125	▲	▲
R105.1819.3.H.4	0,2	1,9	3,7	2,9	7	20	35	0,3	4	105125	Δ	▲
R105.1823.1.H.5	0,2	2,3	4,7	4	7	10	25	0,5	5	105125	▲	▲
R105.1823.2.H.5	0,2	2,3	4,7	4	7	15	30	0,5	5	105125	▲	▲
R105.1823.3.H.5	0,2	2,3	4,7	4	7	20	35	0,5	5	105125	▲	▲
R105.1823.4.H.5	0,2	2,3	4,7	4	7	25	40	0,5	5	105125	▲	▲
R105.1823.5.H.5	0,2	2,3	4,7	4	7	30	45	0,5	5	105125	Δ	▲
R105.1833.2.H.6	0,2	3,3	5,7	4,7	7	15	30	0,5	6	105125	Δ	▲
R105.1833.3.H.6	0,2	3,3	5,7	4,7	7	20	35	0,5	6	105125	Δ	▲
R105.1833.4.H.6	0,2	3,3	5,7	4,7	7	25	40	0,5	6	105125	Δ	▲
R105.1833.5.H.6	0,2	3,3	5,7	4,7	7	30	45	0,5	6	105125	Δ	▲
R105.1840.3.H.7	0,2	4	6,4	5,2	7	20	35	0,5	7	105125	▲	▲
R105.1840.4.H.7	0,2	4	6,4	5,2	7	25	40	0,5	7	105125	Δ	▲
R105.1840.5.H.7	0,2	4	6,4	5,2	7	30	45	0,5	7	105125	Δ	▲

Ab Bohrungsdurchmesser 1 mm rechte Schneidplatten verwenden.

Der Klemmhalter B105.0016.U1.01 muss auf Lage 0° eingebaut werden - siehe technische Hinweise.

Bore diameter from 1 mm right-hand inserts used.

Toolholder B105.0016.U1.01 must be installed at position 0° - see technical instructions.

P	●	●
M	●	●
K	○	●
N	-	●
S	-	●
H	-	-

Schneidplatte Insert

105

Ø > 3 mm

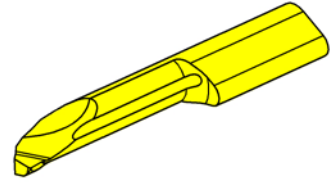
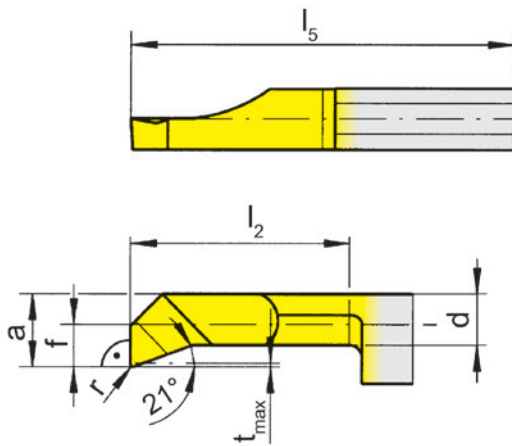
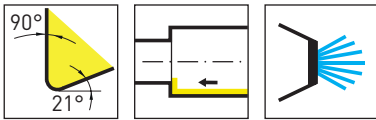

R = rechts wie gezeichnet
R = right hand version shown

▲ ab Lager
on stock

HM-Sorten
Carbide grades
▲ 4 Wochen
4 weeks

Bestellnummer Part number	r	f	a	d	b	l ₂	l ₅	t _{max}	D _{min}	HIS	EG35	IG35	TH35	TN35
R105.9013.01.1.3	0,1	1,3	2,6	2,3	5,9	10	25	0,15	3	105123	▲	▲	▲	
R105.9013.01.2.3	0,1	1,3	2,6	2,3	5,9	15	30	0,15	3	105123	▲	▲	▲	
R105.9013.1.3	0,2	1,3	2,6	2,3	5,9	10	25	0,15	3	105123	▲	▲		▲
R105.9013.2.3	0,2	1,3	2,6	2,3	5,9	15	30	0,15	3	105123	▲	▲		▲
R105.9019.01.1.4	0,1	1,9	3,7	2,9	6,4	10	25	0,3	4	105124	▲	▲	▲	
R105.9019.01.2.4	0,1	1,9	3,7	2,9	6,4	15	30	0,3	4	105124	▲	▲	▲	
R105.9019.01.3.4	0,1	1,9	3,7	2,9	6,4	20	35	0,3	4	105124	▲	▲	▲	
R105.9019.1.4	0,2	1,9	3,7	2,9	6,4	10	25	0,3	4	105124	▲	▲		▲
R105.9019.2.4	0,2	1,9	3,7	2,9	6,4	15	30	0,3	4	105124	▲	▲		▲
R105.9023.01.1.5	0,1	2,3	4,7	4	7	10	25	0,5	5	105125	▲	▲	▲	
R105.9023.01.2.5	0,1	2,3	4,7	4	7	15	30	0,5	5	105125	▲	▲	▲	
R105.9023.01.3.5	0,1	2,3	4,7	4	7	20	35	0,5	5	105125	▲	▲	▲	
R105.9023.01.4.5	0,1	2,3	4,7	4	7	25	40	0,5	5	105125	▲	▲	▲	
R105.9023.1.5	0,2	2,3	4,7	4	7	10	25	0,5	5	105125	▲	▲	▲	▲
R105.9023.2.5	0,2	2,3	4,7	4	7	15	30	0,5	5	105125	▲	▲	▲	▲
R105.9023.3.5	0,2	2,3	4,7	4	7	20	35	0,5	5	105125	▲	▲		▲
P	●	-	●	●							●	●	●	●
M	●	●	●	●							●	●	●	●
K	○	-	●	●							●	●	●	●
N	-	-	●	●							●	●	●	●
S	-	●	●	●							●	●	●	●
H	-	-	-	-										

Ab Bohrungsdurchmesser 1 mm rechte Schneidplatten verwenden.
Der Klemmhalter B105.0016.U1.01 muss auf Lage 0° eingebaut werden - siehe technische Hinweise.
Bore diameter from 1 mm right-hand inserts used.
Toolholder B105.0016.U1.01 must be installed at position 0° - see technical instructions.

Schneidplatte Insert

105

$\emptyset > 5 \text{ mm}$

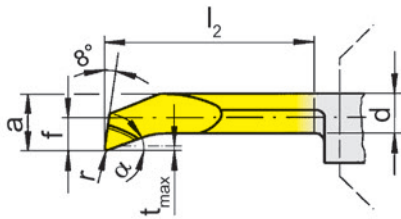
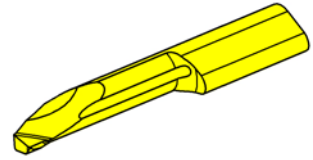
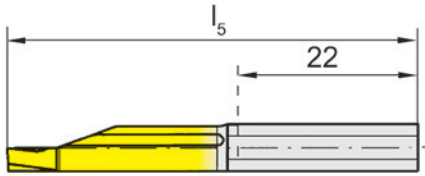
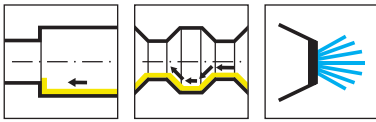

D

R = rechts wie gezeichnet
R = right hand version shown

▲ ab Lager
on stock

HM-Sorten
Carbide grades
Δ 4 Wochen
4 weeks

Bestellnummer Part number	r	f	a	d	b	l ₂	l ₅	t _{max}	D _{min}	α	HIS	EG35	TH35	TI25
R105.1823.4.5.2	0,1	2,3	4,7	4,2	7	25	50	0,3	5	21°	105225	Δ	▲	▲
R105.1823.5.5.2	0,1	2,3	4,7	4,2	7	30	55	0,3	5	21°	105225	Δ	▲	▲
R105.1833.4.6.2	0,1	3,3	5,7	4,9	7	25	50	0,3	6	21°	105225	Δ	▲	▲
R105.1833.5.6.2	0,1	3,3	5,7	4,9	7	30	55	0,3	6	21°	105225	Δ	▲	▲
R105.1840.4.7.2	0,1	4	6,4	5,4	7	25	50	0,3	6,8	21°	105225	Δ	▲	▲
R105.1840.5.7.2	0,1	4	6,4	5,4	7	30	55	0,3	6,8	21°	105225	Δ	▲	▲
R105.1840.7.7.2	0,1	4	6,4	5,4	7	40	65	0,3	6,8	21°	105225	▲	▲	▲
R105.4733.5.6.2	0,1	3,3	5,7	3,7	7	30	55	1,8	6	47°	105225	Δ	▲	▲
												P	●	●
												M	●	●
												K	○	●
												N	-	●
												S	-	●
												H	-	-

Ab Bohrungsdurchmesser 1 mm rechte Schneidplatten verwenden.
Der Klemmhalter B105.0016.U1.02 muss auf Lage 0° eingebaut werden - siehe technische Hinweise.
Bore diameter from 1 mm right-hand inserts used.
Toolholder B105.0016.U1.02 must be installed at position 0° - see technical instructions.

Schneidplatte Insert

110

Ø > 6 mm

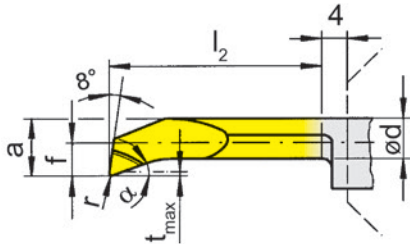
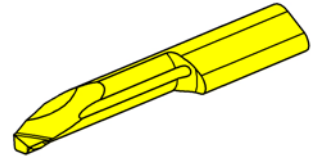
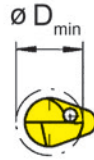
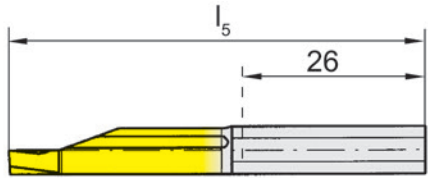
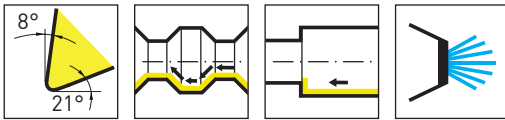

R = rechts wie gezeichnet
R = right hand version shown

▲ ab Lager
on stock

HM-Sorten
Carbide grades
Δ 4 Wochen
4 weeks

Bestellnummer Part number	r	f	a	d	l ₂	l ₅	t _{max}	D _{min}	α	HIS	EG35	TH35	TI25
R110.1829.7.6	0,2	2,9	5,7	4,8	40	70	0,5	6	21°	110260	▲	▲	▲
R110.1829.9.6	0,2	2,9	5,7	4,8	50	80	0,5	6	21°	110260	▲	▲	▲
R110.1829.9.8	0,2	4	7,4	6	50	80	0,5	8	21°	110260	▲	▲	▲
											P	●	●
											M	●	●
											K	○	●
											N	-	●
											S	-	●
											H	-	-

Ab Bohrungsdurchmesser 1 mm rechte Schneidplatten verwenden.
Der Klemmhalter B105.0016.U1.01 muss auf Lage 0° eingebaut werden - siehe technische Hinweise.
Bore diameter from 1 mm right-hand inserts used.
Toolholder B105.0016.U1.01 must be installed at position 0° - see technical instructions.



D



URMA

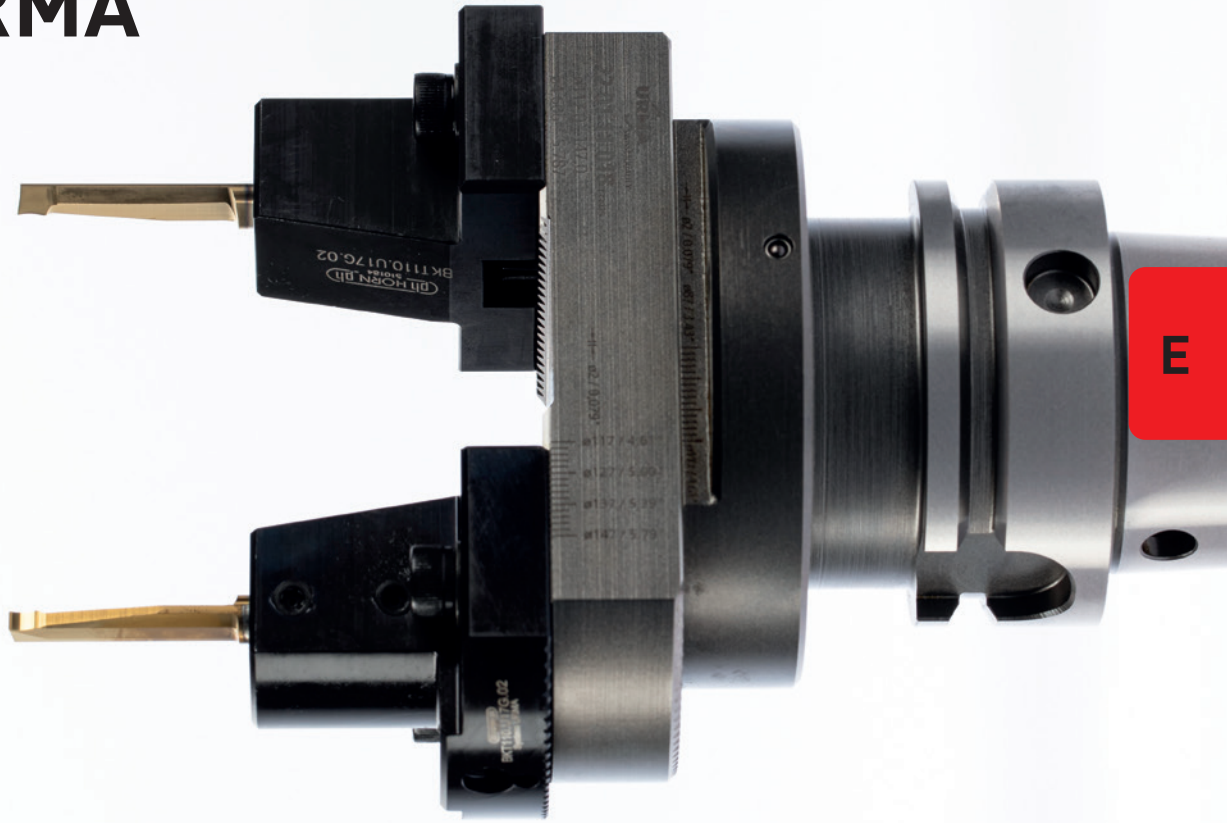

**Axialeinstechen mit
URMA-IntraMax**

**Face Grooving
with URMA IntraMax**

Übersicht
Overview

Seite/Page
81-83

Grundaufnahme URMA
Basic Holder Urma
C11/D11/H11/HSK-A 11
T11



Seite/Page
84



Seite/Page
90

Zwischenkonsole URMA
Intermediate adaptors URMA
BKT/B21



Seite/Page
85



Seite/Page
91

Durchmesserkonsole
URMA
Diameter extender URMA
22



Seite/Page
86



Seite/Page
92

Einstellbare Halter
Adjustable holder
BKT



Seite/Page
87-88



Seite/Page
93-95

Ausgleichsgewicht
Balancing weight
020/23



Seite/Page
89



Seite/Page
96

Schneidplatte
Insert
105/A110

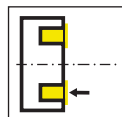

Seite/Page
97-101, 103

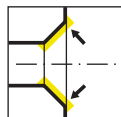

Seite/Page
102

Wendeschneidplatte
Indexable insert
A315

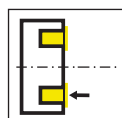

Seite/Page
104

Aufnahme mit Beta-Modul 40/63

Adaptor with Beta-Module 40/63

Kapitel Systemaufnahmen URMA/chapter System Adaptors URMA

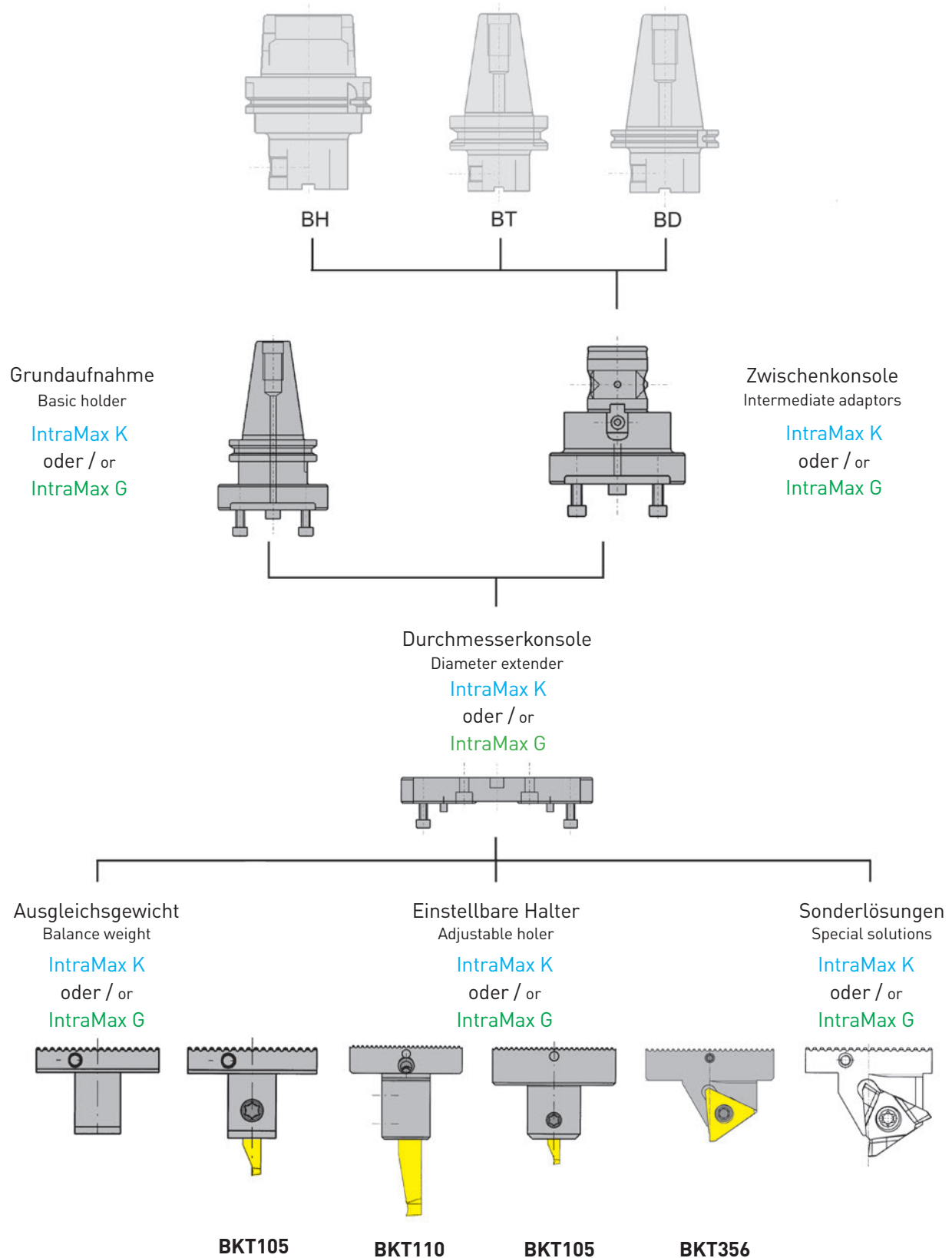

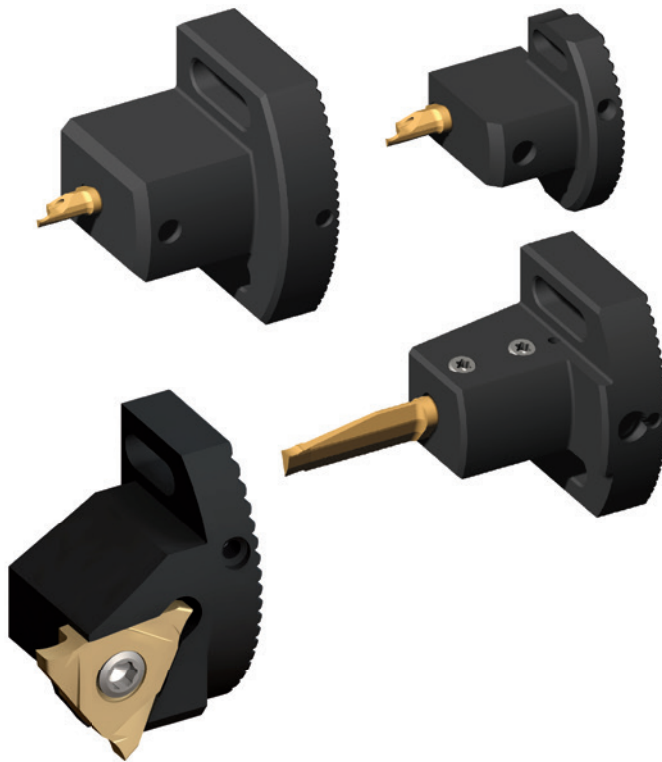

t_{\max} bis 5,0 mm
mit Schneidplatte Typ 105

t_{\max} bis 30 mm
mit Schneidplatte Typ A110

t_{\max} bis 3,0 mm
mit Schneidplatte Typ 315

t_{\max} up to 5.0 mm
with insert type 105

t_{\max} up to 30 mm
with insert type A110

t_{\max} up to 3.0 mm
with insert type 315

E

Wird das Werkzeug mit nur einem einstellbaren Halter zusammen gestellt, empfehlen wir nach Möglichkeit auf der Gegenseite ein Ausgleichsgewicht zu verwenden.

Mit zwei Einbauhaltern ist folgendes möglich :

- Zweischneidiges Einstechen bzw. Plansenken (effektive Zähneanzahl = 2)
- Einstechen mit versetzter Nutinnen- und Nutaußenkante (effektive Zähneanzahl = 1)
- Zwei separate Einstiche (effektive Zähneanzahl = 1)

Werden zwei einstellbare Halter aufgebaut, ist es mitunter erforderlich, dass die Werkzeuglängen zueinander eingestellt werden. Standardmäßig beinhaltet nur der einstellbare Halter BKT110.U17G.02 für Schneidentyp A110 eine Längeneinstellung.

If the tool is assembled with only one adjustable holder, we recommend using a counterweight on the opposite if possible.

The following is possible with two cartridges:

- Double-edged grooving or counterboring (effective number of teeth = 2)
- Grooving with offset groove inner and outer edge (effective number of teeth = 1)
- Two separate grooves (effective number of teeth = 1)

If two adjustable holders are set up, it is sometimes necessary to adjust the tool length relative to each other. As standard, only the adjustable holder BKT110.U17G.02 for insert type A110 includes length adjustment.

Das für die Bohrungsbearbeitung konzeptionierte modulare System URMA IntraMax, eignet sich auch für andere Bearbeitungen, wie z.B. Ausspindeln, Axialeinstechen, Plan- und Profilsenken oder weitere Sonderlösungen.

In Kombination mit HORN-Steichsystemen können so rotierende Werkzeuge für Fräsmaschinen zusammen gestellt werden.

Es stehen zwei nicht kompatible IntraMax Systemgrößen zur Verfügung:

IntraMax K, (klein) für Ø49-88 mm, Konsolenbreite 35 mm, Verstellweg 8 mm radial.

IntraMax G, (groß) für Ø87-297 mm, Konsolenbreite 49 mm, Verstellweg 15 mm radial.

Der Durchmesserbereich der Zwischenkonsole kann mittels Aufbau einer Durchmesserkonsole erweiterte werden. Jede Konsole deckt einen bestimmten Durchmesserbereich ab.

Die Bereiche von URMA Plattenhaltern und die der HORN-Steichsysteme sind abweichend. Siehe Tabelle.

The URMA IntraMax modular system, designed for boring, is also suitable for other machining operations, such as finish boring, face grooving, counterboring and countersinking or other special solutions. In combination with HORN grooving systems, rotating tools for milling machines can be assembled.

Two non-compatible IntraMax system sizes are available:

IntraMax K, (small) for Ø49-88 mm, adaptor width 35 mm, adjustment range 8 mm radial.

IntraMax G, (large) for Ø87-Ø297 mm, adaptor width 49 mm, adjustment range 15 mm radial.

The diameter range of the intermediate adaptor can be increased by building up a diameter extender. Each intermediate adaptor covers a specific diameter range.

The ranges of URMA insert holders and those of the HORN grooving systems are different. See table.

IntraMax K - IntraMax Ø49 - Ø88 mm, Konsolenbreite / width of adapter = 35 mm

mit Durchmesserkonsole with diameter extender	URMA-ISO	HORN BKT105/110	HORN BKT365
-	49-62	5-18	47-61
22 03 06 012	62-75	18-31	60-74
22 03 07 012	75-88	31-45	73-87

IntraMax G - IntraMax Ø49 - Ø297 mm, Konsolenbreite / width of adapter = 49 mm

mit Durchmesserkonsole with diameter extender	URMA-ISO	HORN BKT105/110	HORN BKT365
-	87-117	31-61	80,5-110,5
22 01 11 018	117-147	61-91	110,5-140,5
22 01 14 018	147-177	91-121	140,5-170,5
22 01 17 018	177-207	121-151	170,5-200,5
22 01 20 023	207-237	151-181	200,5-230,5
22 01 23 023	237-267	181-211	230,5-260,5
22 01 26 028	269-297	211-241	260,5-290,5

Grundaufnahme URMA C11/D11/H11/ Basic Holder Urma

C11/D11/H11/ HSK-A 11/T11

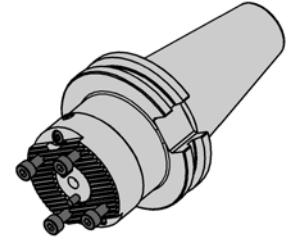
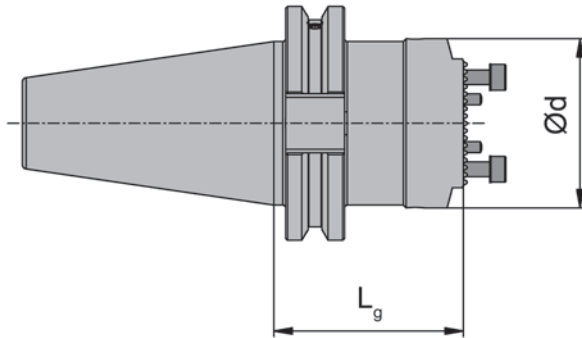
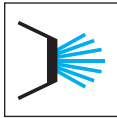

E

Bestellnummer Part number	L _g	d	Durchmesserbereich für Diameter Range for Typ / type 105 / 315	Gewicht [kg] Weight [kg]	System
C11 41 03 052	52	46	5 - 18 / -	1,2	CAT40
D11 41 03 052	52	46	5 - 18 / 47 - 61	1,2	SK40/A
H11 43 03 052	52	46	5 - 18 / 47 - 61	1,2	SK40/B
HSKA 11 63 03	60	46	5 - 18 / 47 - 61	1,3	HSKA-63
T11 41 03 052	52	46	5 - 18 / 47 - 61	1,3	MAS-BT40

Ersatzteile

Spare Parts

Grundaufnahme URMA Basic Holder Urma	Spannschraube Clamping Screw
C11 41 03 052	C00 22 05
H11 43 03 052	C00 22 05
HSKA 11 63 03	C00 22 05

Zwischenkonsole URMA BKT

Intermediate adaptors URMA



Beta-Modul

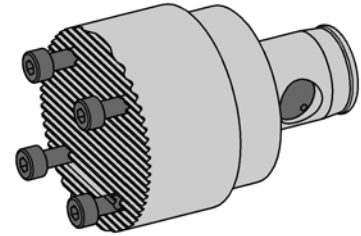
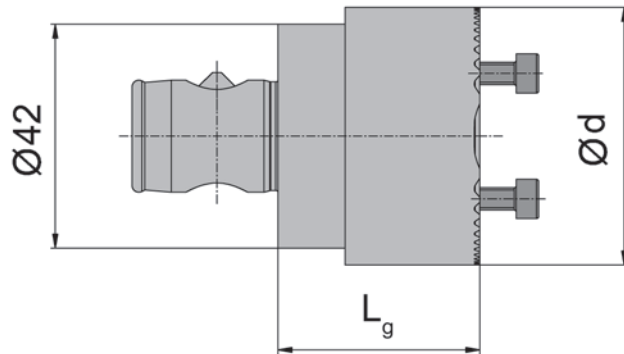

Bestellnummer Part number	L _g	d	Durchmesserbereich für Diameter Range for Typ / type 105 / 315	Beta-Modul	Gewicht [kg] Weight [kg]
B21 40 46 036	36	46	5 - 18 / 47 - 61	40	0,5

Ersatzteile

Spare Parts

Zwischenkonsole URMA Intermediate adaptors URMA	Schraube Screw	Spannschraube Clamping Screw
B21 40 46 036	C00 22 58	C00 22 05



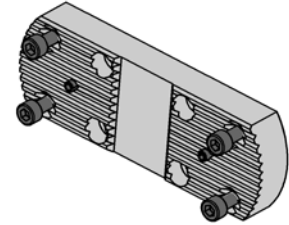
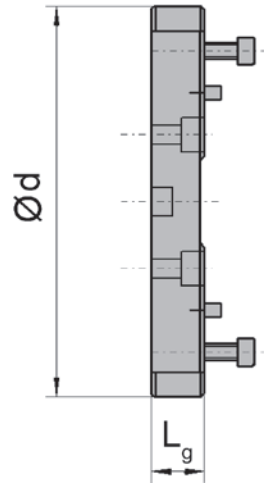

E

Bestellnummer Part number	Lg	d	Durchmesserbereich für Diameter Range for Typ / type 105 / 315	Gewicht [kg] Weight [kg]
22 03 06 012	12	59	18 - 31 / 60 - 74	0,2
22 03 07 012	12	72	31 - 45 / 73 - 87	0,3

Ersatzteile

Spare Parts

Durchmesserkonsole URMA Diameter extender URMA	Spannschraube Clamping Screw
22 0...	C00 22 05

Einstellbare Halter

Adjustable holder

BKT $\emptyset \geq 5 \text{ mm}$

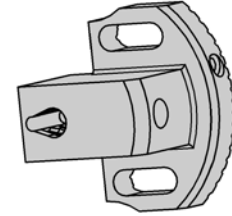
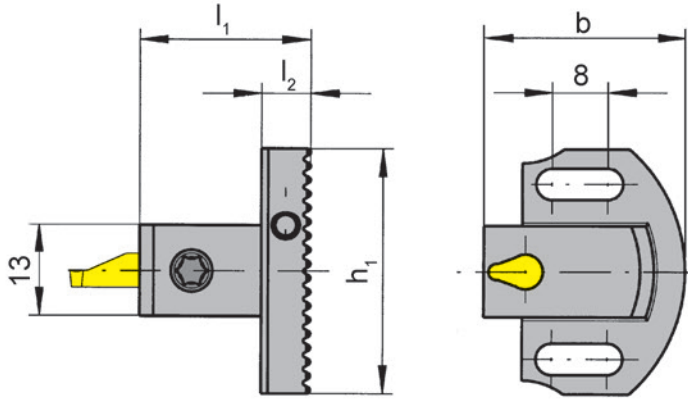
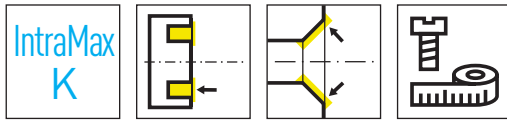

Bestellnummer Part number	l_1	h_1	b	l_2	Gewicht [kg] Weight [kg]	HWS
BKT105.U90K.01	24,5	35	28,5	7	0,1	105123 • 105124 • 105125

Spannlänge 12 mm
Clamping length 12 mm

2 Einbauhalter sind einsetzbar ab $Da_{\min} = 2x (6 \text{ mm} + f \text{ Schneidplatte})$
2 Cartridges are suitable from $Da_{\min} = 2x (6 \text{ mm} + f \text{ Insert})$

Ersatzteile

Spare Parts

Einstellbare Halter Adjustable holder	Spannschraube Clamping Screw	TORX PLUS®-Schlüssel TORX PLUS® Wrench
BKT105.U90K.01	6.075T15P	T15PQ



Einstellbare Halter

Adjustable holder

BKT $\varnothing \geq 47$ mm

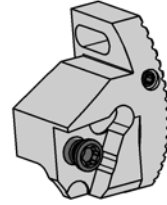
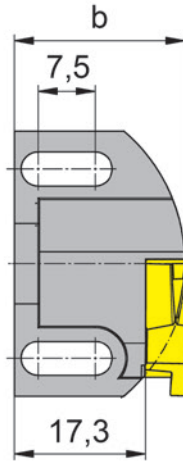
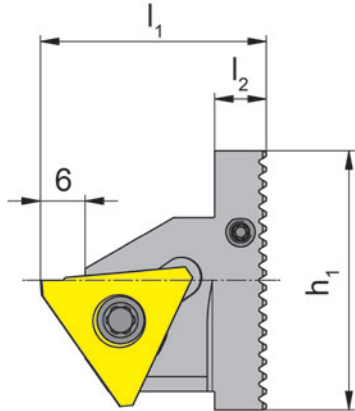
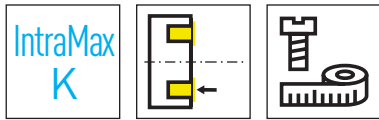

E

Bestellnummer Part number	l_1	h_1	b	l_2	Gewicht [kg] Weight [kg]	HWS
BKT356.U90K.05	30,5	35	22,8	7	0,1	31505R

2 Einbauhalter sind einsetzbar von $\varnothing 47 - 87$ mm
2 Cartridges are suitable from $\varnothing 47 - 87$ mm

Ersatzteile

Spare Parts

Einstellbare Halter Adjustable holder	Spannschraube Clamping Screw	TORX PLUS®-Schlüssel TORX PLUS® Wrench
BKT356.U90K.05	5.12T20P	T20PQ

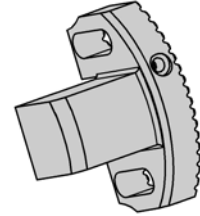
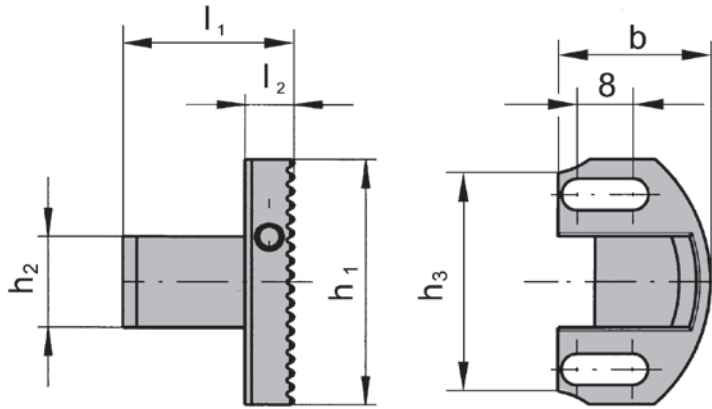

Bestellnummer Part number	l_1	h_2	h_1	h_3	b	l_2	Gewicht [kg] Weight [kg]
020.U00K.2040	24,5	13	35	31	22	7	0,1

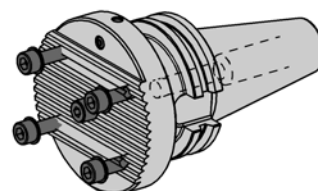
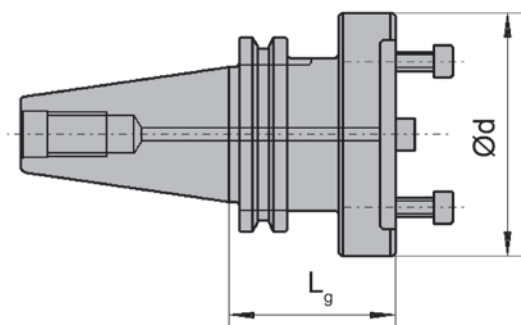

E

Bestellnummer Part number	L _g	d	Durchmesserbereich für Diameter Range for Typ / type 105 / 315	Gewicht [kg] Weight [kg]	System
D11 41 01 054	54	80	31 - 61 / 80,5 - 110,5	1,4	SK40/A
H11 43 01 054	54	80	31 - 61 / 80,5 - 110,5	1,4	SK40/B
HSKA 11 63 01	60	80	31 - 61 / 80,5 - 110,5	1,4	HSKA-63
T11 41 01 054	54	80	31 - 61 / 80,5 - 110,5	1,5	MAS-BT40

Ersatzteile

Spare Parts

Grundaufnahme URMA Basic Holder Urma	Spannschraube Clamping Screw
D/H/HSKA/T11...	C00 22 02

Zwischenkonsole URMA B21

Intermediate adaptors URMA



Beta-Modul

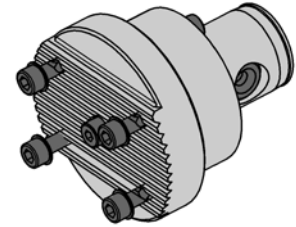
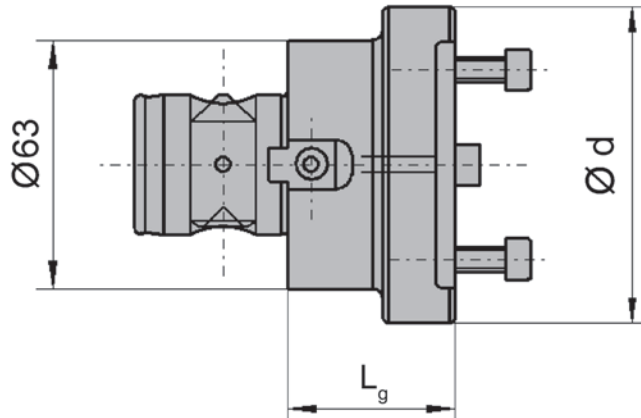

Bestellnummer Part number	L _g	d	Durchmesserbereich für Diameter Range for Typ / type 105 / 315	Beta-Modul	Gewicht [kg] Weight [kg]
B21 63 80 042	42	80	31 - 61 / 80,5 - 110,5	63	0,8

Ersatzteile

Spare Parts

Zwischenkonsole URMA Intermediate adaptors URMA	Spannschraube Clamping Screw
B21 63 80 042	C00 22 05



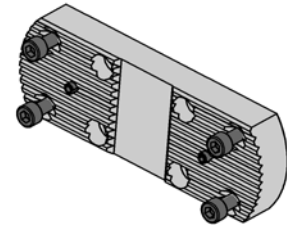
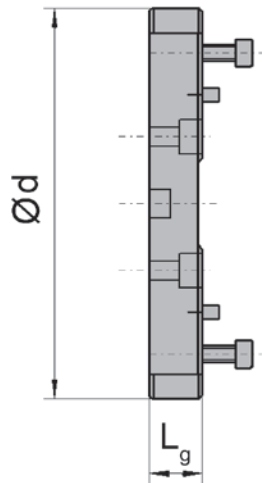

E

Bestellnummer Part number	Lg	d	Durchmesserbereich für Diameter Range for Typ / type 105 / 315	Gewicht [kg] Weight [kg]
22 01 11 018	18	110	61 - 91 / 110,5 - 140,5	0,8
22 01 14 018	18	140	91 - 122 / 140,5 - 170,5	1
22 01 17 018	18	170	121 - 151 / 170,5 - 200,5	1,2

Ersatzteile

Spare Parts

Durchmesserkonsole URMA Diameter extender URMA	Schraube Screw	Spannschraube Clamping Screw
22 0...	C00 22 02	C00 22 05

Einstellbare Halter

Adjustable holder

BKT $\varnothing \geq 31 \text{ mm}$

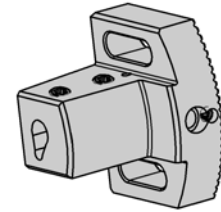
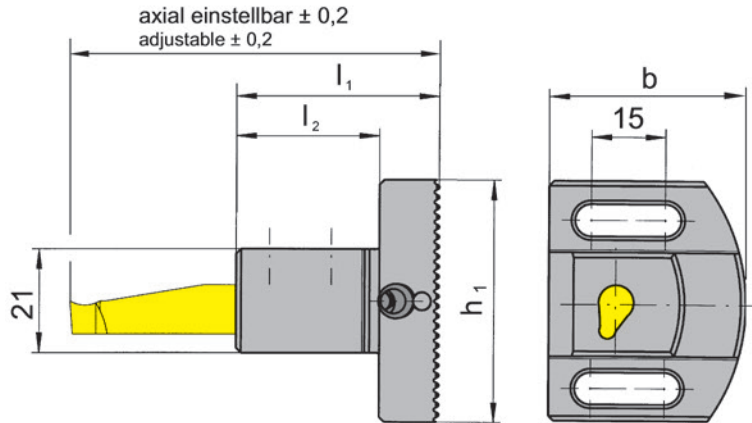
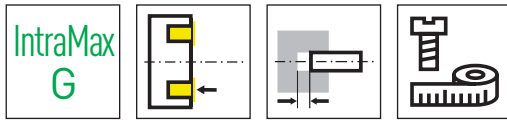

Bestellnummer Part number	l_1	l_2	h_1	b	Gewicht [kg] Weight [kg]	HWS
BKT110.U17G.02	41	26	49	39,5	0,3	110260

nur für rechte Schneidplatten
for right hand inserts only

2 Halter sind einsetzbar ab $Da \text{ min} = 2x (13,5 \text{ mm} + f \text{ Schneidplatte})$
2 Holders can be used from $Da \text{ min} = 2x (13,5 \text{ mm} + f \text{ Insert})$

Ersatzteile

Spare Parts

Einstellbare Halter Adjustable holder	Spannschraube Clamping Screw	TORX PLUS®-Schlüssel TORX PLUS® Wrench
BKT110.U17G.02	6.075T15P	T15PQ



Einstellbare Halter

Adjustable holder

BKT $\emptyset \geq 31 \text{ mm}$

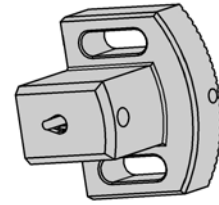
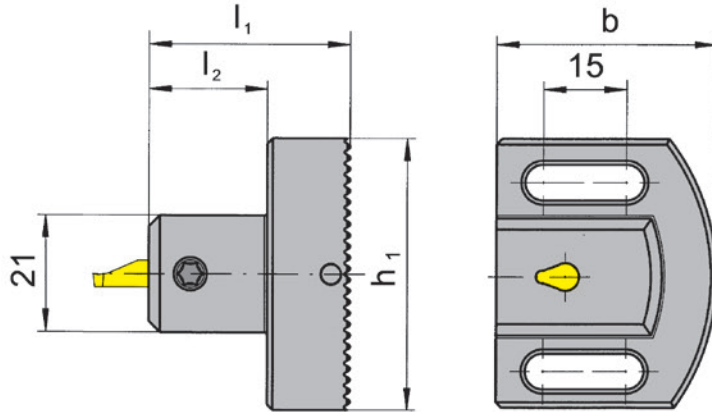
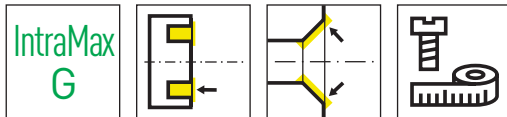

E

Bestellnummer Part number	l_1	l_2	h_1	b	Gewicht [kg] Weight [kg]	HWS
BKT105.U90G.01	36,4	24,4	49	39,5	0,3	105123 • 105124 • 105125

Spannlänge 12 mm
Clamping length 12 mm

Ersatzteile

Spare Parts

Einstellbare Halter Adjustable holder	Spannschraube Clamping Screw	TORX PLUS®-Schlüssel TORX PLUS® Wrench
BKT105.U90G.01	6.075T15P	T15PQ

Einstellbare Halter

Adjustable holder

BKT $\varnothing \geq 81 \text{ mm}$

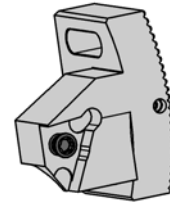
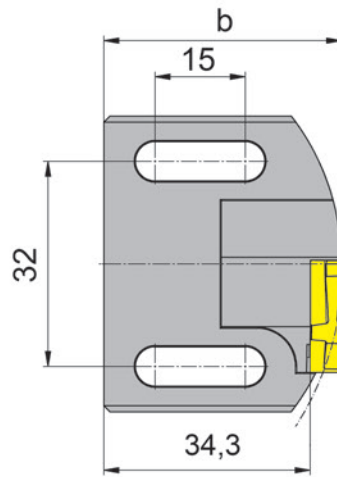
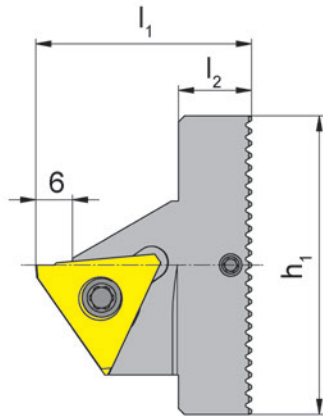
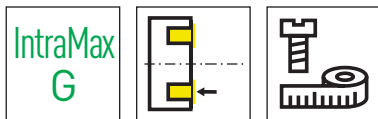

Bestellnummer Part number	l_1	h_1	b	l_2	Gewicht [kg] Weight [kg]	HWS
BKT356.U90G.05	42,4	49	39,8	12	0,3	31505R

nur für rechte Schneidplatten
for right hand inserts only

2 Halter sind einsetzbar von $\varnothing 81 - 200 \text{ mm}$
2 Holder are suitable from $\varnothing 81 - 200 \text{ mm}$

Ersatzteile

Spare Parts

Einstellbare Halter Adjustable holder	Spannschraube Clamping Screw	TORX PLUS®-Schlüssel TORX PLUS® Wrench
BKT356.U90G.05	5.12T20P	T20PQ



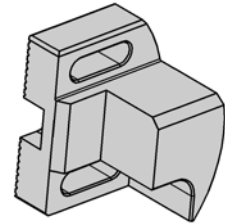
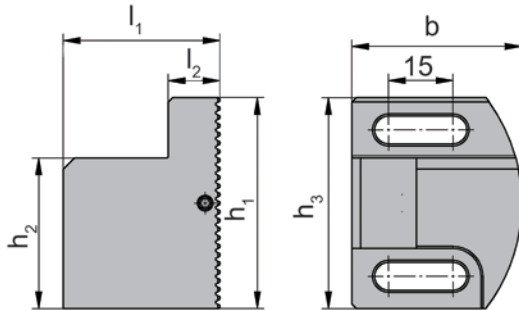

E

Bestellnummer Part number	l_1	h_2	h_1	h_3	b	l_2	Gewicht [kg] Weight [kg]
23 01 10 036	36,4	34,8	49	49	39,5	12,5	0,3

Ersatzteile

Spare Parts

Ausgleichsgewicht Balancing weight	Schraube Screw
23 01 10 036	C00 22 02

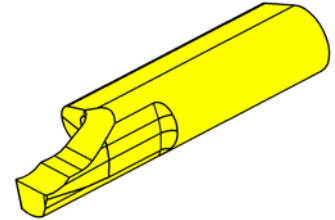
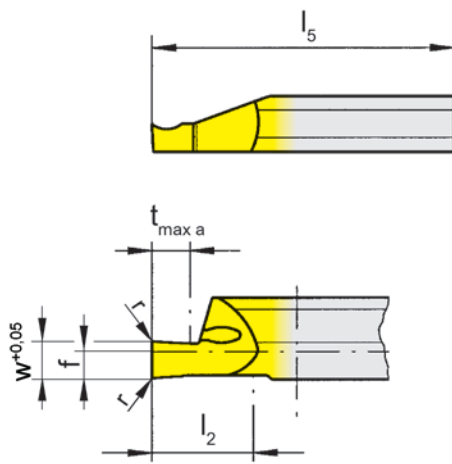
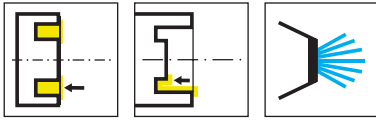

R = rechts wie gezeichnet
R = right hand version shown

L = links spiegelbildlich
L = left hand version

▲ ab Lager
on stock

HM-Sorten
Carbide grades
Δ 4 Wochen
4 weeks

Bestellnummer Part number	w	r	f	b	l ₂	l ₅	t _{max a}	D _{a min}	HIS	MG12	EG35	TI25
R105.0510.1.8	1	0,05	2	7	10	25	2	5	105125	▲	▲	▲
R105.0515.1.8	1,5	0,05	2	7	10	25	3	5	105125	▲	▲	▲
R105.0520.1.8	2	0,05	2	7	10	25	5	5	105125	▲	▲	▲
R105.0510.2.8	1	0,05	2	7	15	35	2	5	105125	Δ	▲	▲
R105.0515.2.8	1,5	0,05	2	7	15	35	3	5	105125	Δ	▲	▲
R105.0520.2.8	2	0,05	2	7	15	35	5	5	105125	Δ	▲	▲
L105.0510.1.8	1	0,05	2	7	10	25	2	5	105125	▲	▲	▲
L105.0515.1.8	1,5	0,05	2	7	10	25	3	5	105125	▲	▲	▲
L105.0520.1.8	2	0,05	2	7	10	25	5	5	105125	Δ	▲	▲
L105.0510.2.8	1	0,05	2	7	15	35	2	5	105125	Δ	Δ	▲
L105.0515.2.8	1,5	0,05	2	7	15	35	3	5	105125	Δ	▲	▲
L105.0520.2.8	2	0,05	2	7	15	35	5	5	105125	Δ	▲	▲
P										●	●	●
M										-	●	●
K										-	○	●
N										-	-	●
S										-	-	●
H										-	-	-



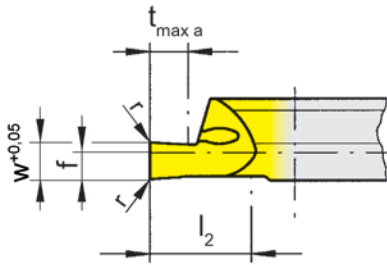
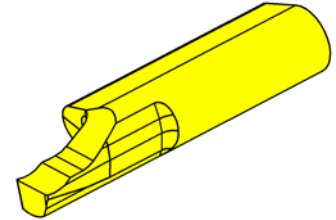
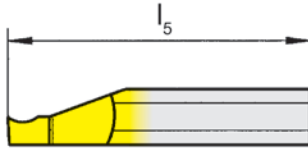
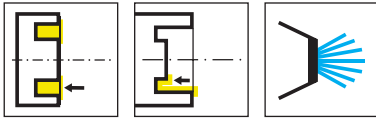

E

R = rechts wie gezeichnet
R = right hand version shown

L = links spiegelbildlich
L = left hand version

▲ ab Lager
on stock

HM-Sorten
Carbide grades
Δ 4 Wochen
4 weeks

Bestellnummer Part number	w	r	f	b	l ₂	l ₅	t _{max a}	D _{a min}	HIS	MG12	EG35	TI25
R105.0610.1.8	1	0,05	2	7	10	25	2	6	105125	▲	▲	▲
R105.0615.1.8	1,5	0,05	2	7	10	25	3	6	105125	▲	▲	▲
R105.0620.1.8	2	0,05	2	7	10	25	5	6	105125	▲	▲	▲
R105.0610.2.8	1	0,05	2	7	15	35	2	6	105125	▲	▲	▲
R105.0615.2.8	1,5	0,05	2	7	15	35	3	6	105125	▲	▲	▲
R105.0620.2.8	2	0,05	2	7	15	35	5	6	105125	▲	▲	▲
L105.0610.1.8	1	0,05	2	7	10	25	2	6	105125	Δ	▲	▲
L105.0615.1.8	1,5	0,05	2	7	10	25	3	6	105125	Δ	▲	▲
L105.0620.1.8	2	0,05	2	7	10	25	5	6	105125	Δ	▲	▲
L105.0610.2.8	1	0,05	2	7	15	35	2	6	105125	Δ	Δ	▲
L105.0615.2.8	1,5	0,05	2	7	15	35	3	6	105125	Δ	Δ	▲
L105.0620.2.8	2	0,05	2	7	15	35	5	6	105125	Δ	Δ	▲
P										●	●	●
M										-	●	●
K										-	○	●
N										-	-	●
S										-	-	●
H										-	-	-

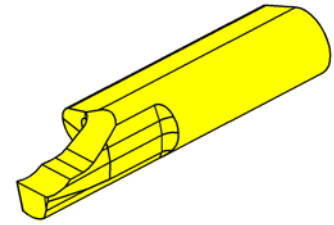
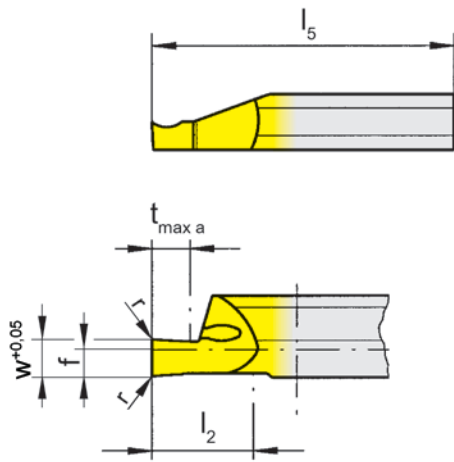
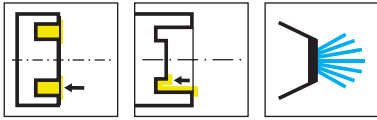

R = rechts wie gezeichnet
R = right hand version shown

L = links spiegelbildlich
L = left hand version

▲ ab Lager
on stock

HM-Sorten
Carbide grades
Δ 4 Wochen
4 weeks

Bestellnummer Part number	w	r	f	b	l ₂	l ₅	t _{max a}	D _{a min}	HIS	EG35	TI25
R105.0810.1.8	1	0,15	2	7	10	25	2	8	105125	▲	▲
R105.0815.1.8	1,5	0,15	2	7	10	25	3	8	105125	▲	▲
R105.0820.1.8	2	0,15	2	7	10	25	4	8	105125	▲	▲
R105.0825.1.8	2,5	0,15	2	7	10	25	5	8	105125	▲	▲
R105.0830.1.8	3	0,15	2	7	10	25	6	8	105125	▲	▲
R105.0810.2.8	1	0,15	2	7	15	35	2	8	105125	▲	▲
R105.0815.2.8	1,5	0,15	2	7	15	35	3	8	105125	▲	▲
R105.0820.2.8	2	0,15	2	7	15	35	4	8	105125	▲	▲
R105.0825.2.8	2,5	0,15	2	7	15	35	5	8	105125	▲	▲
R105.0830.2.8	3	0,15	2	7	15	35	6	8	105125	▲	▲
L105.0810.1.8	1	0,15	2	7	10	25	2	8	105125	▲	▲
L105.0815.1.8	1,5	0,15	2	7	10	25	3	8	105125	▲	▲
L105.0820.1.8	2	0,15	2	7	10	25	4	8	105125	▲	▲
L105.0825.1.8	2,5	0,15	2	7	10	25	5	8	105125	▲	▲
L105.0830.1.8	3	0,15	2	7	10	25	6	8	105125	▲	▲
L105.0810.2.8	1	0,15	2	7	15	35	2	8	105125	▲	▲
L105.0815.2.8	1,5	0,15	2	7	15	35	3	8	105125	▲	▲
L105.0820.2.8	2	0,15	2	7	15	35	4	8	105125	▲	▲
L105.0825.2.8	2,5	0,15	2	7	15	35	5	8	105125	▲	▲
L105.0830.2.8	3	0,15	2	7	15	35	6	8	105125	▲	▲

P	●	●
M	●	●
K	●	●
N	-	●
S	-	●
H	-	-



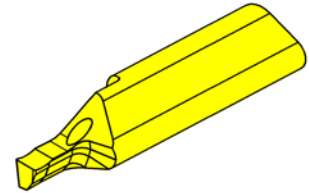
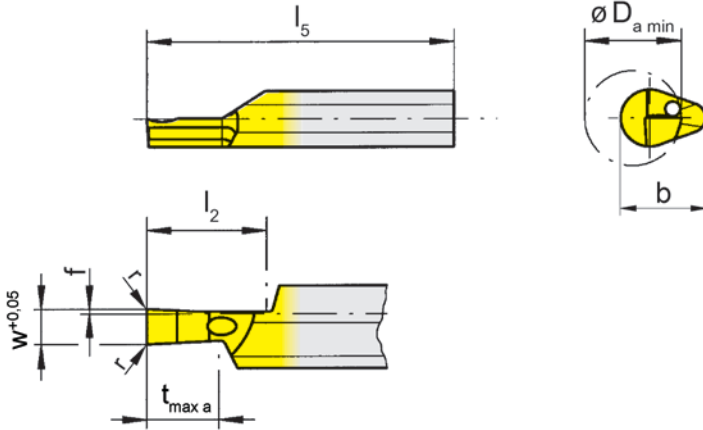
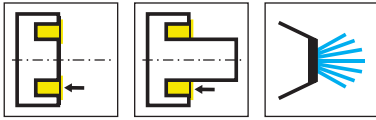

E

R = rechts wie gezeichnet
R = right hand version shown

L = links spiegelbildlich
L = left hand version

▲ ab Lager
on stock

HM-Sorten
Carbide grades
Δ 4 Wochen
4 weeks

Bestellnummer Part number	w	r	f	b	l ₂	l ₅	t _{max a}	D _{a min}	HIS	EG35	TI25
R105.0810.1.9	1	0,15	0,4	7	10	25	2	8	105125	▲	▲
R105.0815.1.9	1,5	0,15	0,4	7	10	25	3	8	105125	▲	▲
R105.0820.1.9	2	0,15	0,4	7	10	25	4	8	105125	▲	▲
R105.0825.1.9	2,5	0,15	0,4	7	10	25	5	8	105125	▲	▲
R105.0830.1.9	3	0,15	0,4	7	10	25	6	8	105125	▲	▲
L105.0810.1.9	1	0,15	0,4	7	10	25	2	8	105125	▲	▲
L105.0815.1.9	1,5	0,15	0,4	7	10	25	3	8	105125	▲	▲
L105.0820.1.9	2	0,15	0,4	7	10	25	4	8	105125	▲	▲
L105.0825.1.9	2,5	0,15	0,4	7	10	25	5	8	105125	▲	▲
L105.0830.1.9	3	0,15	0,4	7	10	25	6	8	105125	▲	▲
										P	●
										M	●
										K	●
										N	-
										S	-
										H	-

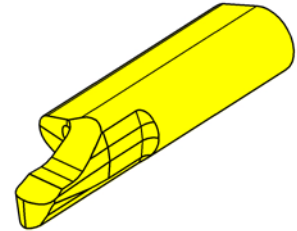
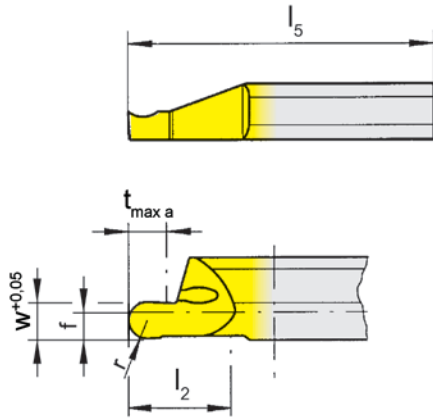
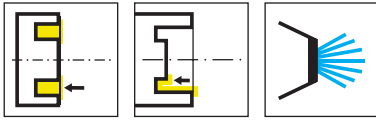

R = rechts wie gezeichnet
R = right hand version shown

L = links spiegelbildlich
L = left hand version

▲ ab Lager
on stock

HM-Sorten
Carbide grades
Δ 4 Wochen
4 weeks

Bestellnummer Part number	w	r	f	b	l ₂	l ₅	t _{max a}	D _{a min}	HIS	EG35	TI25
R105.8V10.1.8	1	0,5	2	7	10	25	2	8	105125	▲	▲
R105.8V16.1.8	1,6	0,8	2	7	10	25	3	8	105125	▲	▲
R105.8V20.1.8	2	1	2	7	10	25	4	8	105125	▲	▲
R105.8V25.1.8	2,5	1,25	2	7	10	25	5	8	105125	▲	▲
R105.8V30.1.8	3	1,5	2	7	10	25	6	8	105125	▲	▲
R105.8V10.2.8	1	0,5	2	7	15	35	2	8	105125	▲	▲
R105.8V16.2.8	1,6	0,8	2	7	15	35	3	8	105125	▲	▲
R105.8V20.2.8	2	1	2	7	15	35	4	8	105125	▲	▲
R105.8V25.2.8	2,5	1,25	2	7	15	35	5	8	105125	▲	▲
R105.8V30.2.8	3	1,5	2	7	15	35	6	8	105125	▲	▲
L105.8V10.1.8	1	0,5	2	7	10	25	2	8	105125	▲	▲
L105.8V16.1.8	1,6	0,8	2	7	10	25	3	8	105125	▲	▲
L105.8V20.1.8	2	1	2	7	10	25	4	8	105125	▲	▲
L105.8V25.1.8	2,5	1,25	2	7	10	25	5	8	105125	Δ	▲
L105.8V30.1.8	3	1,5	2	7	10	25	6	8	105125	▲	▲
L105.8V10.2.8	1	0,5	2	7	15	35	2	8	105125	Δ	▲
L105.8V16.2.8	1,6	0,8	2	7	15	35	3	8	105125	Δ	▲
L105.8V20.2.8	2	1	2	7	15	35	4	8	105125	▲	▲
L105.8V25.2.8	2,5	1,25	2	7	15	35	5	8	105125	Δ	Δ
L105.8V30.2.8	3	1,5	2	7	15	35	6	8	105125	Δ	▲

P	●	●
M	●	●
K	○	●
N	-	●
S	-	●
H	-	-



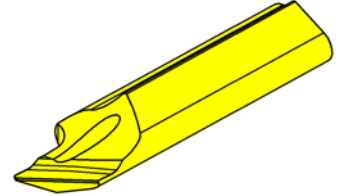
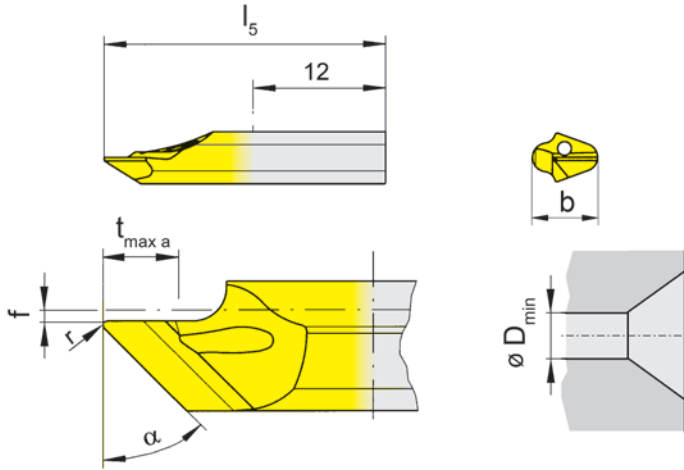
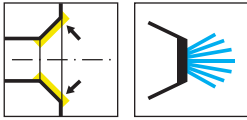

E

R = rechts wie gezeichnet
R = right hand version shown

L = links spiegelbildlich
L = left hand version

▲ ab Lager
on stock

HM-Sorten
Carbide grades
Δ 4 Wochen
4 weeks

Bestellnummer Part number	r	f	b	l ₅	t _{max a}	D _{min}	α	HIS		EG35	TH35	TI25	TN35
R105.0045.0.1	0,2	0,5	5,9	20	3,5	1	45°	105123	▲	▲			▲
R105.0045.1.1	0,2	0,5	5,9	25	3,5	1	45°	105123	▲	▲	Δ		
R105.0060.0.1	0,2	0,5	5,9	20	4	1	60°	105123	▲				
R105.0060.1.1	0,2	0,5	5,9	25	4	1	60°	105123	▲	▲	Δ		
L105.0045.0.1	0,2	0,5	5,9	20	3,5	1	45°	105123	▲	▲			▲
L105.0045.1.1	0,2	0,5	5,9	25	3,5	1	45°	105123	▲	▲	Δ		
L105.0060.0.1	0,2	0,5	5,9	20	4	1	60°	105123	▲	▲			
L105.0060.1.1	0,2	0,5	5,9	25	4	1	60°	105123	▲	▲	Δ		
									P	●	●	●	●
									M	●	●	●	●
									K	○	●	●	●
									N	-	●	●	●
									S	-	●	●	●
									H	-	-	-	-

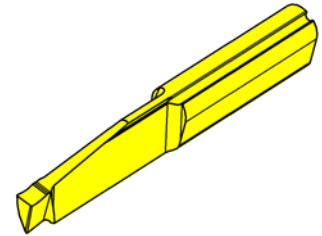
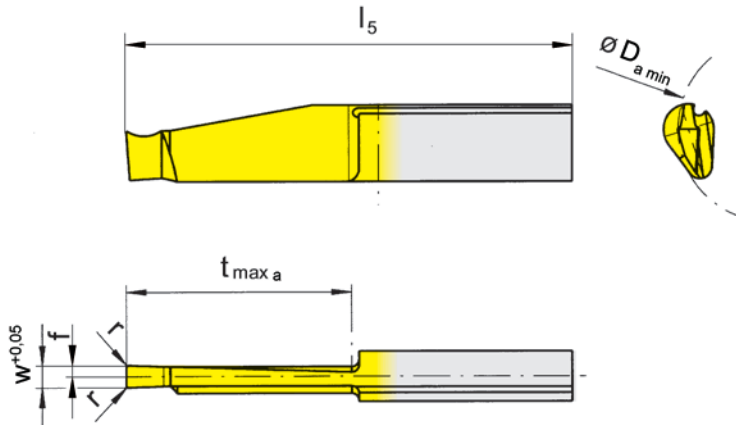
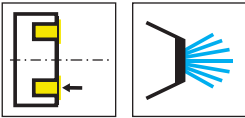

R = rechts wie gezeichnet
R = right hand version shown

L = links spiegelbildlich
L = left hand version

▲ ab Lager
on stock

HM-Sorten
Carbide grades
Δ 4 Wochen
4 weeks

Bestellnummer Part number	w	r	f	l ₅	t _{max a}	D _{a min}	HIS	EG35	TH35	TI25	TN35
RA110.2030.3.0	3	0,2	1,5	50	20	20	110260	▲	▲	▲	▲
RA110.2030.5.0	3	0,2	1,5	60	30	20	110260	▲	▲	▲	▲
RA110.5030.3.0	3	0,2	1,5	50	20	50	110260	▲		▲	
RA110.5030.5.0	3	0,2	1,5	60	30	50	110260	▲		▲	

Hinweis für RA110.2030...:

Axialstechen ins Volle bei voller Stechtiefe nur bei Da min 20 - 50 mm möglich!

Note for RA110.2030...:

Face grooving with full width of the full depth only possible between Da min 20 - 50 mm.

P	●	●	●	●
M	●	●	●	●
K	○	●	●	●
N	-	●	●	●
S	-	●	●	●
H	-	-	-	-



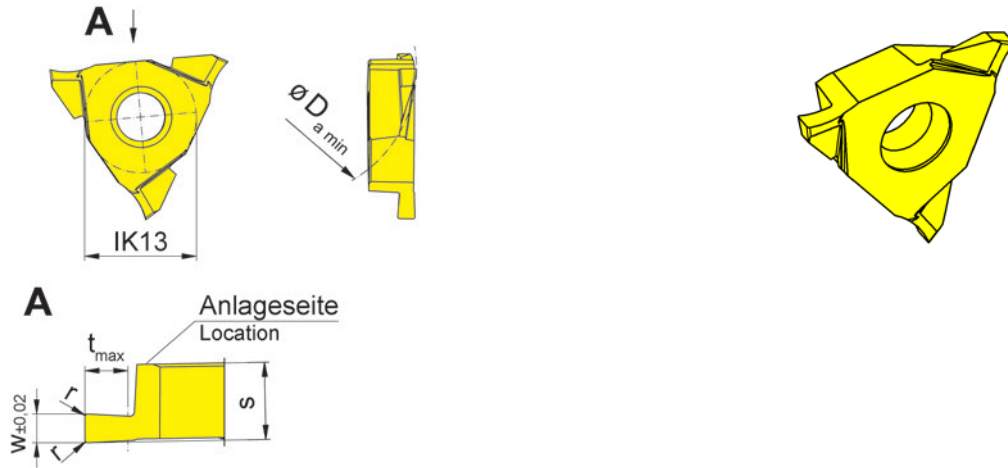
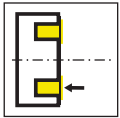

E

R = rechts wie gezeichnet
R = right hand version shown

▲ ab Lager
on stock

HM-Sorten
Carbide grades
Δ 4 Wochen
4 weeks

Bestellnummer Part number	w	r	t _{max}	D _{a min}	s	HIS	TH35
RA315.2015.02R	1,5	0,2	2	20	5,4	31505R	Δ
RA315.3020.02R	2	0,2	3	30	5,4	31505R	▲
RA315.3030.02R	3	0,2	3	30	5,4	31505R	Δ
							P ●
							M ●
							K ●
							N ●
							S ●
							H -

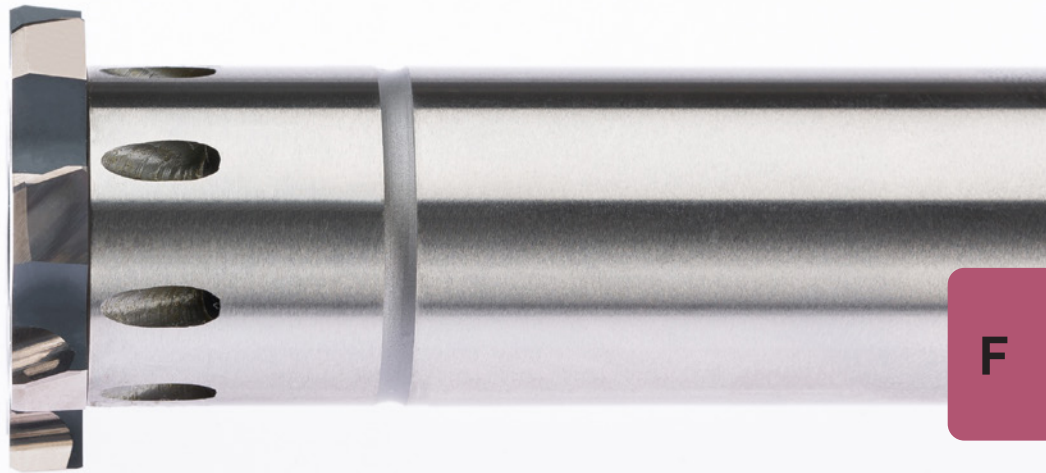

F

System/System	Seite/Page
Übersicht Overview	106
DR small	108
DR medium	122
DR large	160
Technische Hinweise Technical Instructions	179

DR small

Hochleistungsreiben ist in neue Dimensionen vorgestoßen, durch das kleinste Wechselkopf-Reibsystem der Welt.

High-performance reaming has entered new dimensions with the world's smallest exchangeable insert reaming system.



Größe size	Ds _{min}	Ds _{max}
DR08	7,600	8,1
DR10	8,101	9,6
DR11	9,601	11,1
DR13	11,101	13,1

DR medium

Reiben neu definiert durch einzigartiges Design, entwickelt für höchste Produktivität. Dieses hochpräzise Wechselkopfsystem ist der Garant für beste Prozesssicherheit.

Reaming newly innovated and defined by a unique design, engineered for high productivity. This high-precision exchangeable insert reaming system is the guarantee for best process reliability.



Größe size	Ds _{min}	Ds _{max}
016	11,900	15,6
019	15,601	18,6
024	18,601	23,6
029	23,601	28,6
036	28,601	35,6
044	35,601	43,6
052	43,601	51,6
061	51,601	60,6
081	60,601	80,6
101	80,601	100,6
121	100,601	120,6
141	120,601	140,6

DR large

Leistungsstarkes Reiben für große Durchmesser. Das innovative, flexible Reibsystem, welches alle Vorteile der URMA Wechselkopf-Technologien vereint.

Powerful reaming for large diameters. The innovative, flexible reaming system that combines all the advantages of URMA's exchangeable reaming head technologies.

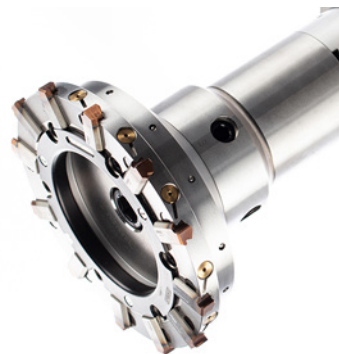

Größe size	Ds _{min}	Ds _{max}
150	139,801	149,8
160	149,801	159,8
170	159,801	169,8
180	169,801	179,8
190	179,801	189,8
200	189,801	200,2

Durchgangsbohrung
Through hole

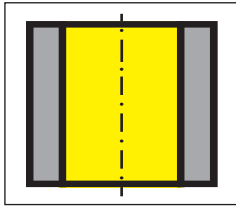

Verzahnung
Helix

Kühlung
Cooland

Geometrie
Geometry

Sorte
Grade

	P	M	K	N	H	S
Verzahnung Helix						
Kühlung Cooland						
Geometrie Geometry	B1	B7	A1	B7	A6	A7 DRS
Sorte Grade	HL3H	HL3H	HL3H	DT2H	AD3H	HL3H

Sacklochbohrung
Blind hole

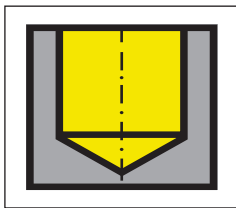

Verzahnung
Helix

Kühlung
Cooland

Geometrie
Geometry

Sorte
Grade

Verzahnung Helix						
Kühlung Cooland						
Geometrie Geometry	A1	A7	A1	A7	A6	A7
Sorte Grade	HL3H	HL3H	HL3H	DT2H	AD3H	HL3H

Absatzbohrung
Blind hole

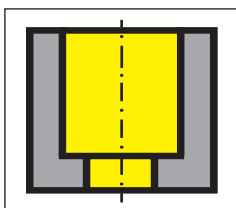

Verzahnung
Helix

Kühlung
Cooland

Geometrie
Geometry

Sorte
Grade

Verzahnung Helix						
Kühlung Cooland						
Geometrie Geometry	A1	A7	A1	A7	A6	A7
Sorte Grade	HL3H	HL3H	HL3H	DT2H	AD3H	HL3H

F

Übersicht
Overview

Seite/Page
110-111

Schneidplatte
Insert
DR small

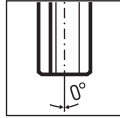

Seite/Page
112, 114, 116

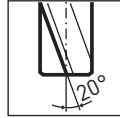

Seite/Page
113, 115, 117

Reibschaff
Reaming insert holder
MDR small

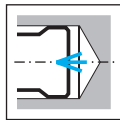

Seite/Page
118

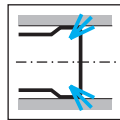

Seite/Page
119

Rundlaufeinstellscheibe
Runout Control Disc
DR small

Seite/Page
120

Technische Hinweise
Technical Instructions

Seite/Page
121

Kapitel
Technische Hinweise
Chapter
Technical Instructions

Seite/Page
179-193

F

DR small

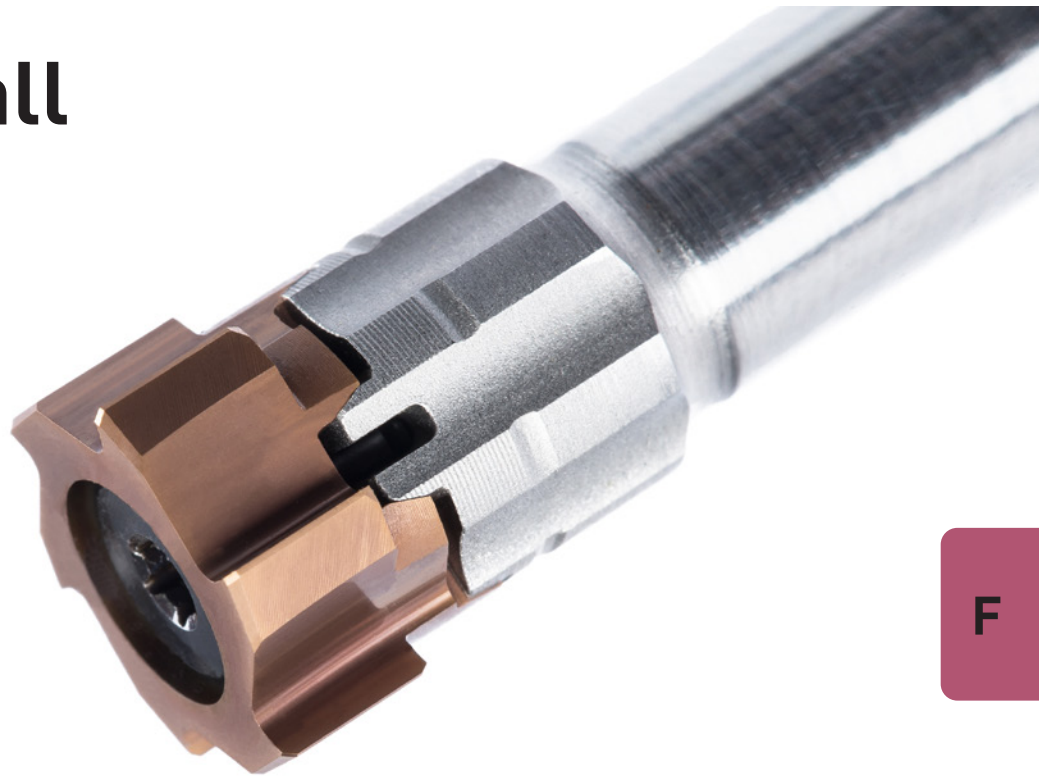

F

Modulares Reibsystem

Ø 7,6 - 13,1 mm

Modular Reaming System

Ø 7,6 - 13,1 mm

Systemgröße DR08-DR13 (small)

System Size DR08-DR13 (small)



für rotierenden Einsatz

for rotating use

Kapitel Hydrodehnspannfutter
Chapter Hydraulic Expansion Toolholder

HDR

Rundlauf
einstellbares
Hydrodehn-
spannfutter

Runout
adjustable hydraulic
expansion toolholder

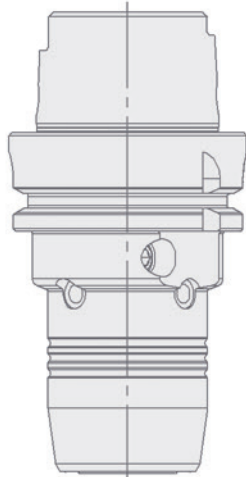

HDZB

Zwischenbüchse
Intermediumate sleeves

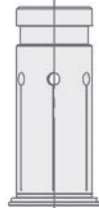

für Einsatz auf Drehmaschinen

for use on lathes

Kapitel Pendelhalter
Chapter Floating holder

PZ

Pendelhalter
Floating holder

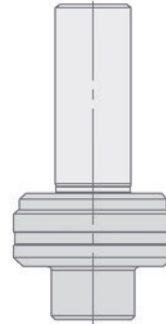

ER

Spannzange
Collet



Dichtscheibe
Seal



Spannmutter
Chucking nut

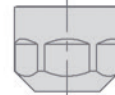

MDR small

Reibschaf
Reaming insert holder



DR small

Schneidplatte
Insert



Spannschraube
Screw



F

Bestellbeispiel Reibschneide

Ordering example of reaming inserts



Bestellbeispiel mit ISO-Toleranzangaben

Ordering example with ISO tolerance

DR.13.12000.H7.A1 HL3H

DR

DR small Systembezeichnung
DR small system designation

13

Plattensitzgröße
Seating size

12,000

Durchmesser in mm
Diameter in mm

H7

Toleranz
Tolerance

A1

Schneidengeometrie
Cutting geometry

HL3H

HM-Sorte
Carbide grade

Erklärung Schneidenmaß

Bei Bestellungen mit Angaben der Bohrungstoleranz wird der Durchmesser durch HORN-Standard definiert. Der Fertigdurchmesser liegt, je nach Größe und Toleranz, etwa im oberen Drittel des Toleranzfeldes.

Beispiel Standard Schneidenbezeichnung:
DR.13.12000.H7.A1 HL3H
Schneide gefertigt auf $\varnothing 12,014 \pm 0,003$ mm

Wenn ein spezifisches Schneidenmaß benötigt wird, muss eine Q-Schneide gewählt werden. Bei Q-Schneiden (Festmaßschneide) wird im Gegensatz zu normalen Schneiden nicht der Bohrungsdurchmesser und die Toleranz, sondern das gewünschte Schneidenendmaß angegeben. Q-Schneiden werden bei speziellen Bearbeitungsbedingungen eingesetzt, bei welchen definierte Standardtoleranzen nicht anwendbar sind.

Beispiel Q-Schneidenbezeichnung:
DR.13.12005.Q3.A1 HL3H
Schneide gefertigt auf $\varnothing 12,005 \pm 0,003$ mm

Bestellbeispiel mit Festmaß (Q-Schneide)

Ordering example with target size (Q insert)

DR.13.12005.Q3.A1 HL3H

DR

DR small Systembezeichnung
DR small system designation

13

Plattensitzgröße
Seating size

12,005

Festmaßdurchmesser in mm
Target size diameter in mm

Q

Code Festmaßschneide
Code for target size insert

3

Fertigungstoleranz +/- μ m
Manufacturing tolerance +/- μ m

A1

Schneidengeometrie
Cutting geometry

HL3H

HM-Sorte
Carbide grade

Explanation of insert size order example

For orders with specifications of the bore tolerance, the diameter is defined by HORN standard. Depending on the size and tolerance, the finished diameter is approximately in the upper third of the tolerance range.

Example standard insert designation:
DR.13.12000.H7.A1 HL3H
insert ground to $\varnothing 12,014 \pm 0,003$ mm

A Q-insert designation is selected for a specific insert dimension. In contrary to standard inserts where all tolerances refer to the bore tolerance, Q-inserts indicates the required insert diameter (target size). Q-inserts are recommended for special applications where standard tolerance ranges are not applicable.

Example Q-insert designation:
DR.13.12005.Q3.A1 HL3H
insert ground to $\varnothing 12,005 \pm 0,003$ mm

F



Abbildung = rechtsschneidend
Picture = right hand cutting version

HM-Sorten
Carbide grades
▲ ab Lager
on stock
Δ 4 Wochen
4 weeks

Bestellnummer Part number	Ds	Toleranz Tolerance	Größe Size	m_1	α	l_2	Z	HL3H
DR.08.08000.H7.A1	8	H7	08	0,25	45	4,5	4	▲
DR.10.09000.H7.A1	9	H7	10	0,25	45	4,5	6	▲
DR.11.10000.H7.A1	10	H7	11	0,25	45	4,5	6	▲
DR.11.11000.H7.A1	11	H7	11	0,25	45	4,5	6	▲
DR.13.12000.H7.A1	12	H7	13	0,25	45	4,5	6	▲
DR.13.13000.H7.A1	13	H7	13	0,25	45	4,5	6	Δ

Empfehlungen für Schneidengeometrie und HM-Sorte kombiniert mit der geeigneten IK-Variante des Reibschafte,
finden Sie in der Übersicht Grundausswahl
Recommendations for cutting geometry and carbide grade combined with the suitable IK variant of the reaming shank can be found in the basic
selection overview

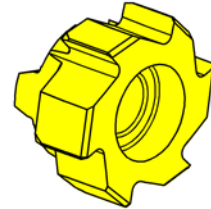
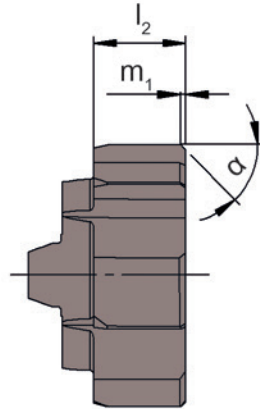
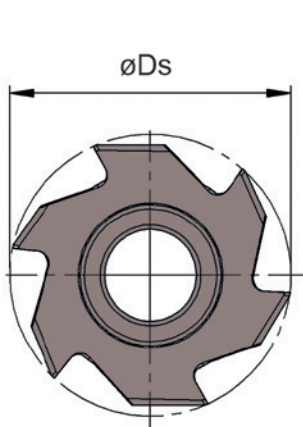
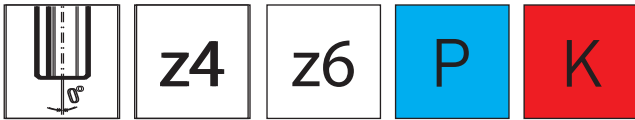
P	●
M	○
K	●
N	○
S	-
H	○



Abbildung = rechtsschneidend
Picture = right hand cutting version

▲ ab Lager
on stock

HM-Sorten
Carbide grades
Δ 4 Wochen
4 weeks

Bestellnummer Part number	Ds	Toleranz Tolerance	Größe Size	m_1	α	l_2	Z	HL3H
DR.08.08000.H7.B1	8	H7	08	0,54	25°	4,5	4	▲
DR.10.09000.H7.B1	9	H7	10	0,54	25°	4,5	6	▲
DR.11.10000.H7.B1	10	H7	11	0,54	25°	4,5	6	▲
DR.11.11000.H7.B1	11	H7	11	0,54	25°	4,5	6	▲
DR.13.12000.H7.B1	12	H7	13	0,54	25°	4,5	6	▲
DR.13.13000.H7.B1	13	H7	13	0,54	25°	4,5	6	▲

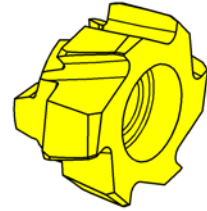
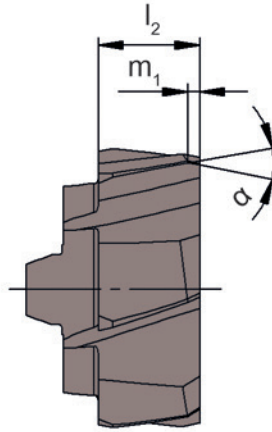
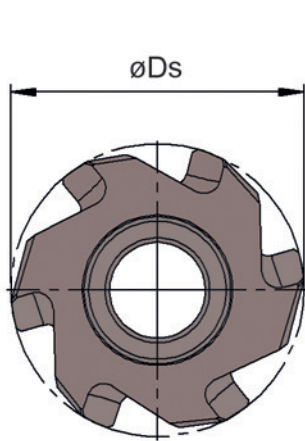
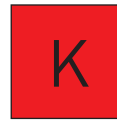
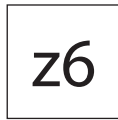
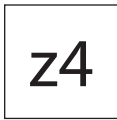
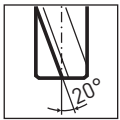
Empfehlungen für Schneidengeometrie und HM-Sorte kombiniert mit der geeigneten IK-Variante des Reibschafte,
finden Sie in der Übersicht Grundausswahl
Recommendations for cutting geometry and carbide grade combined with the suitable IK variant of the reaming shank can be found in the basic
selection overview

P	●
M	○
K	●
N	○
S	-
H	-



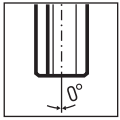

z4

z6

M



Abbildung = rechtsschneidend
Picture = right hand cutting version

HM-Sorten
Carbide grades
▲ ab Lager
on stock
Δ 4 Wochen
4 weeks

Bestellnummer Part number	Ds	Toleranz Tolerance	Größe Size	m_1	α	l_2	Z	HL3H
DR.08.08000.H7.A7	8	H7	08	0,25	45	4,5	4	▲
DR.10.09000.H7.A7	9	H7	10	0,25	45	4,5	6	▲
DR.11.10000.H7.A7	10	H7	11	0,25	45	4,5	6	▲
DR.11.11000.H7.A7	11	H7	11	0,25	45	4,5	6	▲
DR.13.12000.H7.A7	12	H7	13	0,25	45	4,5	6	▲
DR.13.13000.H7.A7	13	H7	13	0,25	45	4,5	6	▲

Empfehlungen für Schneidengeometrie und HM-Sorte kombiniert mit der geeigneten IK-Variante des Reibschafte,
finden Sie in der Übersicht Grundausswahl
Recommendations for cutting geometry and carbide grade combined with the suitable IK variant of the reaming shank can be found in the basic
selection overview

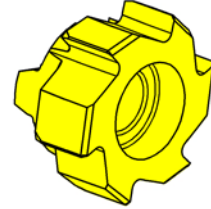
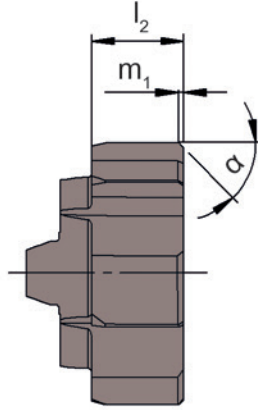
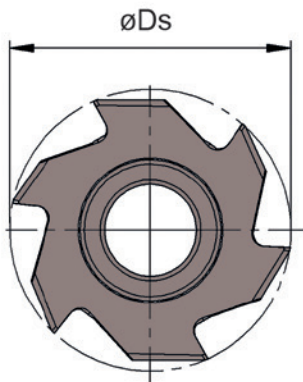
P	●
M	●
K	○
N	○
S	●
H	-



z4

z6

M



Abbildung = rechtsschneidend
Picture = right hand cutting version

▲ ab Lager
on stock

HM-Sorten
Carbide grades
Δ 4 Wochen
4 weeks

Bestellnummer Part number	Ds	Toleranz Tolerance	Größe Size	m_1	α	l_2	Z	HL3H
DR.08.08000.H7.B7	8	H7	08	0,54	25°	4,5	4	▲
DR.10.09000.H7.B7	9	H7	10	0,54	25°	4,5	6	Δ
DR.11.10000.H7.B7	10	H7	11	0,54	25°	4,5	6	▲
DR.11.11000.H7.B7	11	H7	11	0,54	25°	4,5	6	Δ
DR.13.12000.H7.B7	12	H7	13	0,54	25°	4,5	6	▲
DR.13.13000.H7.B7	13	H7	13	0,54	25°	4,5	6	Δ

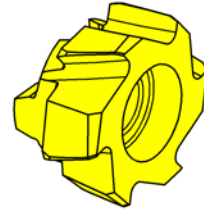
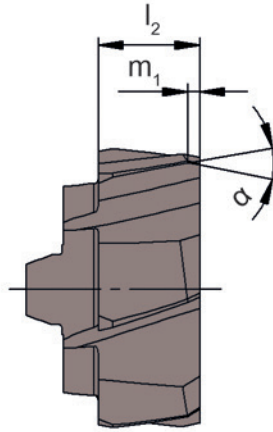
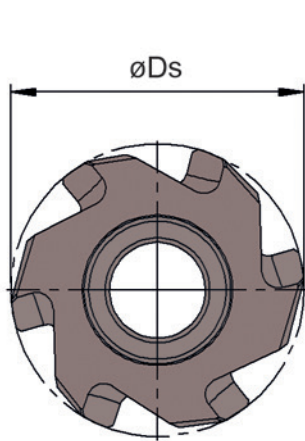
Empfehlungen für Schneidengeometrie und HM-Sorte kombiniert mit der geeigneten IK-Variante des Reibschafte,
finden Sie in der Übersicht Grundausswahl
Recommendations for cutting geometry and carbide grade combined with the suitable IK variant of the reaming shank can be found in the basic
selection overview

P	●
M	●
K	○
N	○
S	○
H	-

F

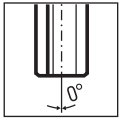

z4

z6

N



Abbildung = rechtsschneidend
Picture = right hand cutting version

HM-Sorten
Carbide grades
▲ ab Lager
on stock
Δ 4 Wochen
4 weeks

Bestellnummer Part number	Ds	Toleranz Tolerance	Größe Size	m_1	α	l_2	Z	DT2H
DR.08.08000.H7.A7	8	H7	08	0,25	45	4,5	4	▲
DR.10.09000.H7.A7	9	H7	10	0,25	45	4,5	6	Δ
DR.11.10000.H7.A7	10	H7	11	0,25	45	4,5	6	▲
DR.11.11000.H7.A7	11	H7	11	0,25	45	4,5	6	Δ
DR.13.12000.H7.A7	12	H7	13	0,25	45	4,5	6	Δ
DR.13.13000.H7.A7	13	H7	13	0,25	45	4,5	6	Δ

Empfehlungen für Schneidengeometrie und HM-Sorte kombiniert mit der geeigneten IK-Variante des Reibschafte,
finden Sie in der Übersicht Grundausswahl
Recommendations for cutting geometry and carbide grade combined with the suitable IK variant of the reaming shank can be found in the basic
selection overview

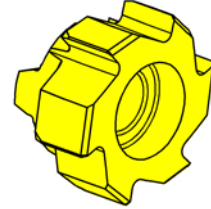
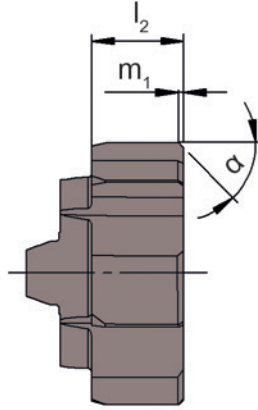
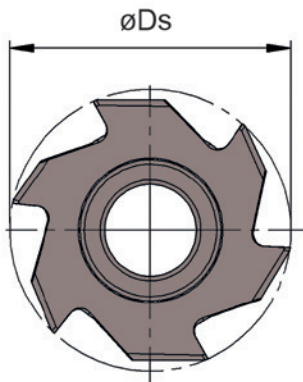
P	-
M	-
K	-
N	●
S	-
H	-

F



z4

z6

N



Abbildung = rechtsschneidend
Picture = right hand cutting version

▲ ab Lager
on stock

HM-Sorten
Carbide grades
Δ 4 Wochen
4 weeks

Bestellnummer Part number	Ds	Toleranz Tolerance	Größe Size	m_1	α	l_2	Z	DT2H
DR.08.08000.H7.B7	8	H7	08	0,54	25°	4,5	4	▲
DR.10.09000.H7.B7	9	H7	10	0,54	25°	4,5	6	Δ
DR.11.10000.H7.B7	10	H7	11	0,54	25°	4,5	6	▲
DR.11.11000.H7.B7	11	H7	11	0,54	25°	4,5	6	Δ
DR.13.12000.H7.B7	12	H7	13	0,54	25°	4,5	6	▲
DR.13.13000.H7.B7	13	H7	13	0,54	25°	4,5	6	Δ

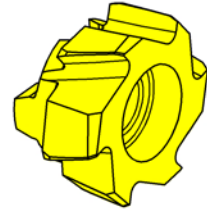
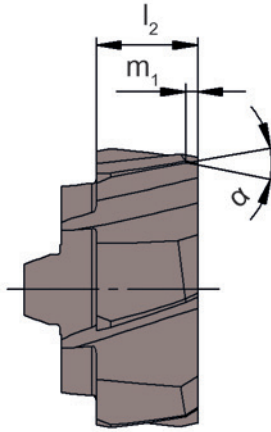
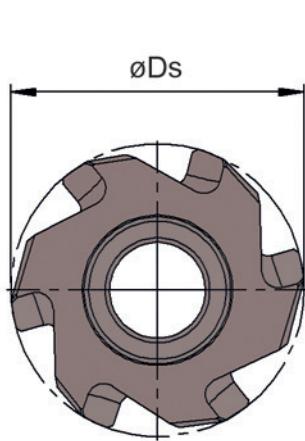
Empfehlungen für Schneidengeometrie und HM-Sorte kombiniert mit der geeigneten IK-Variante des Reibschafths, finden Sie in der Übersicht Grundausswahl
Recommendations for cutting geometry and carbide grade combined with the suitable IK variant of the reaming shank can be found in the basic selection overview

P	-
M	-
K	-
N	●
S	-
H	-

F

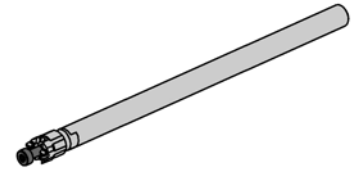
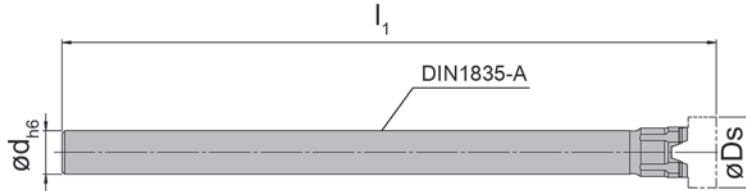
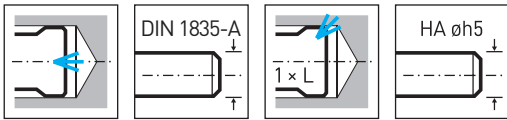

Innere Kühlmittelzufuhr
internal coolant

S = Sackloch, zentral
= Blind hole, central

L = Sackloch, lateral
= Blind hole, lateral

F

Bestellnummer Part number	Ds _{min}	Ds _{max}	l ₁	d	Kühlung Coolant	Größe Size
MDR.08.ST06.086.A.S	7,6	8,1	86	6	L	08
MDR.08.HM06.102.A.S	7,6	8,1	102	6	L	08
MDR.10.ST06.096.A.S	8,101	9,6	96	6	L	10
MDR.10.HM06.116.A.S	8,101	9,6	116	6	L	10
MDR.11.ST08.106.A.S	9,601	11,1	106	8	S	11
MDR.11.HM08.126.A.S	9,601	11,1	126	8	S	11
MDR.13.ST08.120.A.S	11,101	13,1	120	8	S	13
MDR.13.HM08.150.A.S	11,101	13,1	150	8	S	13

Schaftmaterial: HM = Hartmetall ST = Stahl
Material of shank: HM = Carbide ST = Steel

1 Satz Schrauben, 1 Torx-Schlüssel im Lieferumfang enthalten
1 Set of screws, 1 Torx wrench - no separate order required!

Ersatzteile

Spare Parts

Reibschaft Reaming insert holder	Spannschraube Clamping screw
MDR.08...	C009051
MDR.10...	C009052
MDR.11...	C009053B
MDR.13...	C009054B

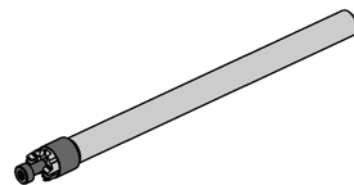
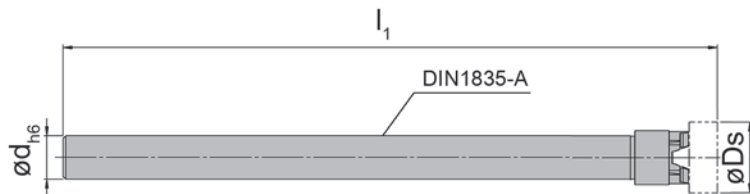
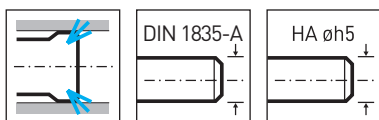

Innere Kühlmittelzufuhr
internal coolant



D = Durchgangsbohrung
= through hole

Bestellnummer Part number	Ds _{min}	Ds _{max}	l ₁	d	Kühlung Coolant	Größe Size
MDR.08.ST06.086.A.D	7,6	8,1	86	6	D	08
MDR.08.HM06.102.A.D	7,6	8,1	102	6	D	08
MDR.10.ST06.096.A.D	8,101	9,6	96	6	D	10
MDR.10.HM06.116.A.D	8,101	9,6	116	6	D	10
MDR.11.ST08.106.A.D	9,601	11,1	106	8	D	11
MDR.11.HM08.126.A.D	9,601	11,1	126	8	D	11
MDR.13.ST08.120.A.D	11,101	13,1	120	8	D	13
MDR.13.HM08.150.A.D	11,101	13,1	150	8	D	13

Schaftmaterial: HM = Hartmetall ST = Stahl
Material of shank: HM = Carbide ST = Steel

1 Satz Schrauben, 1 Torx-Schlüssel im Lieferumfang enthalten
1 Set of screws, 1 Torx wrench - no separate order required!

Ersatzteile

Spare Parts

Reibschaft Reaming insert holder	Spannschraube Clamping screw
MDR.08...	C009051
MDR.10...	C009052
MDR.11...	C009053
MDR.13...	C009054



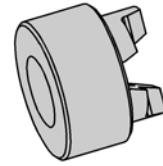
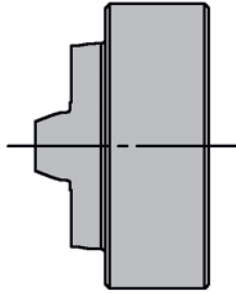

F

Bestellnummer Part number	Größe Size
DR.08.RCD	08
DR.10.RCD	10
DR.11.RCD	11
DR.13.RCD	13

Rundrichten

Um optimale Reibergebnisse zu erzielen, ist ein perfekter Rundlauf des Werkzeuges unumgänglich. Um Rundlauffehler von Aufnahme und Maschinenspindel auszugleichen, werden Ausricht- oder Pendelfutter eingesetzt. Der Rundlauf der HORN DR small Reibwerkzeuge können mit verschiedenen Methoden gemessen werden:

Runout adjustment

To achieve the best reaming results a tool with zero runout is desirable. In order to compensate for any errors due to runout from the toolholders or the machine spindle, we recommend a compensation holder or floating chuck. The runout of HORN DR small reamers can be measured with different methods:

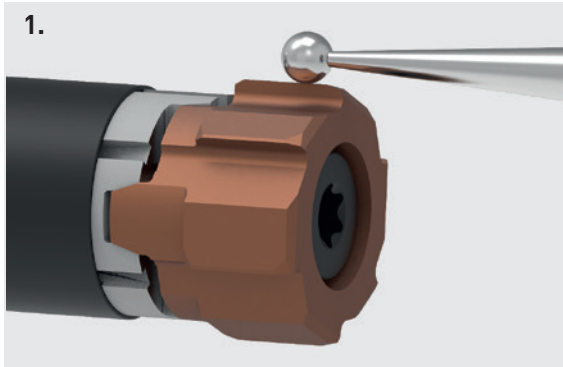

1. Über die Rundschliffase

HORN DR small Werkzeuge werden in enger Toleranz gefertigt. Die Messung über die Rundschliffase liefert eine hervorragende Präzision.

1. On the external diameter of the insert

HORN DR small tools are manufactured very accurately. Runout measuring/adjustment can be done easily through the outside diameter of the insert.

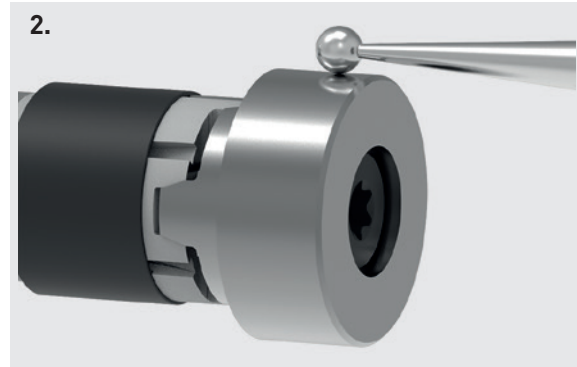

2. Über die Rundlaufeinstellscheibe

Mittels Rundlaufeinstellscheiben kann der Rundlauf noch einfacher überprüft / eingestellt werden.

2. Through runout indicating insert

With the runout indicating insert it's even easier to adjust the runout.

Schneidenwechsel

Für einen optimalen Wechsel der Schneide ist die Reinigung der Schnittstelle, wie auch das Einhalten des vorgeschriebenen Anzugmomentes unabdingbar.

Insert change

For optimal performance proper cleaning of the interface and using the defined tightening torque is imperative.

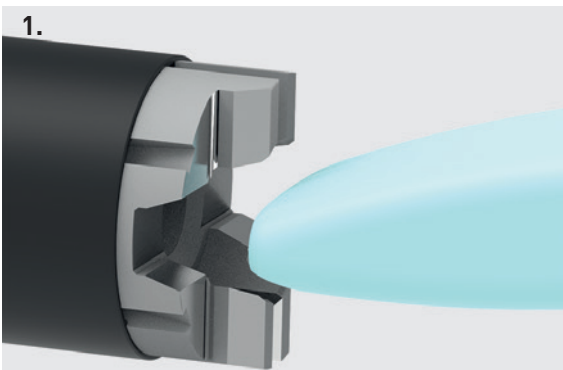

1. Reinigung der Schnittstelle

Die Schnittstelle kann am effektivsten mit Hilfe der in der Schneidenverpackung enthaltenen Knetmasse gereinigt werden.

1. Cleaning of the interface

The interface can be cleaned most effectively with the contained modelling clay in the insert packaging.

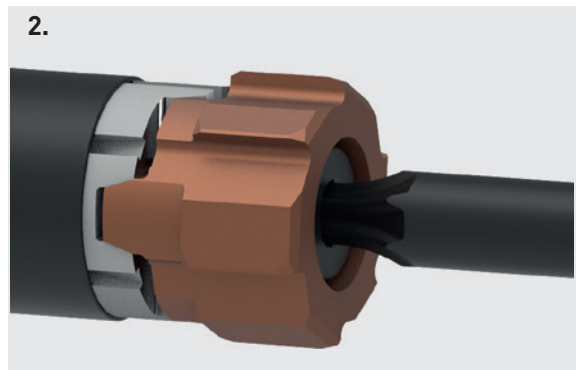

2. Schneidenwechsel

Die Reibschneide wird auf die vorgängig gereinigte Schnittstelle aufgesetzt und mittels vorgeschriebenem Drehmoment angezogen.

2. Insert change

The insert is placed on the previously cleaned interface and tightened through the required tightening torque.

Übersicht
Overview

Seite/Page
124-125, 138-139

Schneidplatte
Insert
DR medium

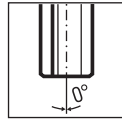

Seite/Page
126, 128, 130,
140, 142, 144

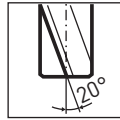

Seite/Page
127, 129, 131,
141, 143, 145

Reibschaff
Reaming insert holder
MDR

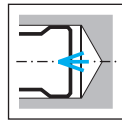

Seite/Page
132, 146

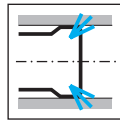

Seite/Page
133, 135, 147

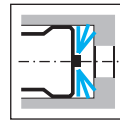

Seite/Page
134, 148

Rundlaufeinstellscheibe
Runout Control Disc
DR medium

Seite/Page
136

Schaft
Shank
VDR

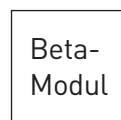

Seite/Page
149

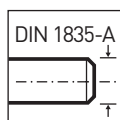

Seite/Page
150

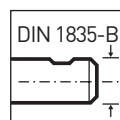

Seite/Page
151

Direktaufnahme
Direct mounting
VDR



Seite/Page
152



Seite/Page
153



Seite/Page
154

Technische Hinweise
Technical Instructions

Seite/Page
156-159

Kapitel
Technische Hinweise
Chapter
Technical Instructions

Seite/Page
179-193

DR medium

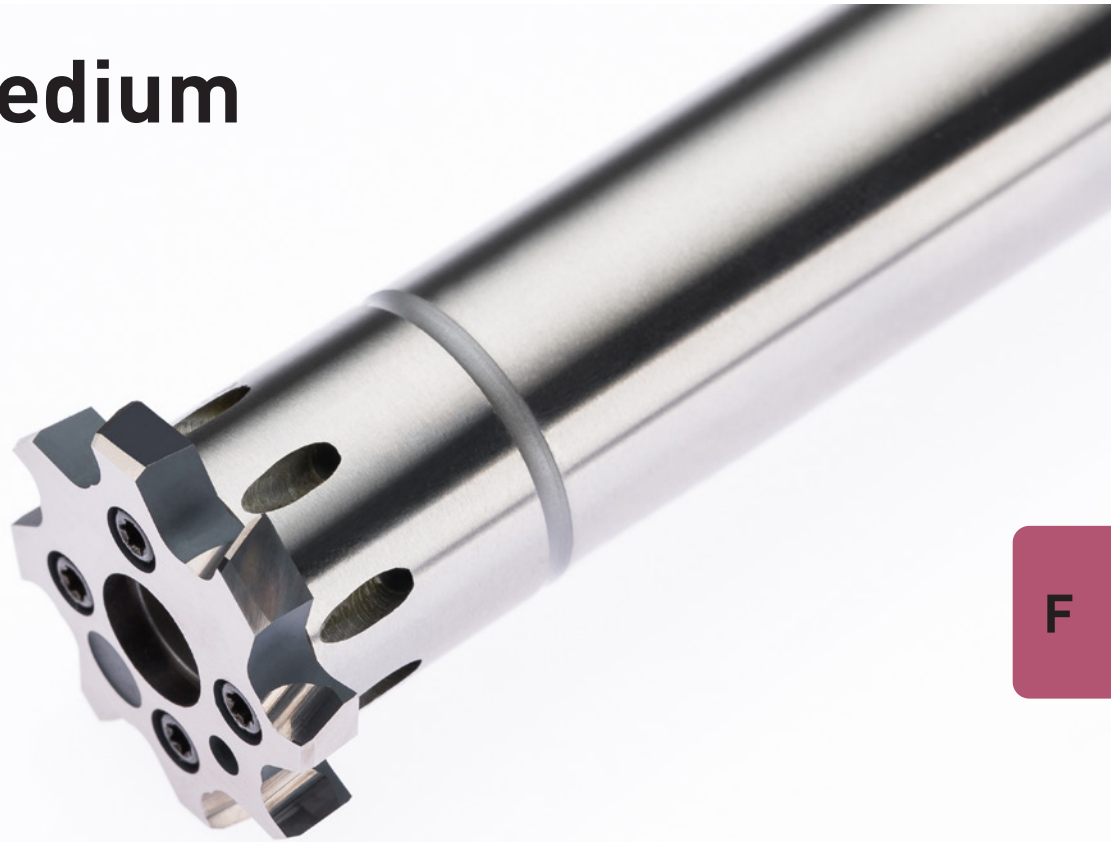

F

Modulares Reibsystem

Ø 11,9 - 35,6 mm
Ø 35,6 - 140,6 mm

Modular Reaming System

Ø 11,9 - 35,6 mm
Ø 35,6 - 140,6 mm

Systemgröße DR016 - DR036

System Size DR016 - DR036



mit Zylinderschaft für Ø 11,900 - 35,600 mm
with cylindrical shank for Ø 11,900 - 35,600 mm

für rotierenden Einsatz
for rotating use

Kapitel Hydrodehnspannfutter
Chapter Hydraulic Expansion Toolholder

für Einsatz auf Drehmaschinen
for use on lathes

Kapitel Pendelhalter
Chapter Floating holder

HDR

Rundlauf
einstellbares
Hydrodehn-
spannfutter

run out
adjustable hydraulic
expansion toolholder

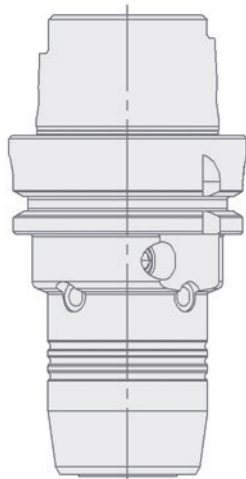

PZ

Pendelhalter
Floating holder



ER

Spannzange
Collet



Dichtscheibe
Seal



Spannmutter
Chucking nut

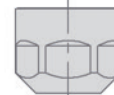

HDZB

Zwischenbüchse
Intermediumate sleeves

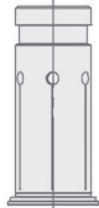

MDR

Reibschaft mit
Standard Schnittstelle
Reaming insert holder
with standard interface



MDR...Z

Reibschaft mit
verstärkter Schnittstelle
Reaming insert holder
with reinforced interface



Spannschraube
Clamping Screw



DR

Schneidplatte
Insert



F

Bestellbeispiel Reibschneide

Ordering example of reaming inserts



Bestellbeispiel mit ISO-Toleranzangaben

Ordering example with ISO tolerance

DR.016.01200.H7.A1 HL3H

DR

DR Systembezeichnung
DR System designation

016

Plattensitzgröße
Seating size

12,00

Durchmesser in mm
Diameter in mm

H7

Toleranz
Tolerance

A1

Schneidengeometrie
Cutting geometry

HL3H

HM-Sorte
Carbide grade

Erklärung Schneidenmaß

Bei Bestellungen mit Angaben der Bohrungstoleranz wird der Durchmesser durch HORN-Standard definiert. Der Fertigdurchmesser liegt, je nach Größe und Toleranz, etwa im oberen Drittel des Toleranzfeldes.

Beispiel Standard Schneidenbezeichnung:
DR.016.01200.H7.A1 HL3H
Schneide gefertigt auf $\varnothing 12,014 \pm 0,003$ mm

Wenn ein spezifisches Schneidenmaß benötigt wird, muss eine Q-Schneide gewählt werden. Bei Q-Schneiden (Festmaßschneide) wird im Gegensatz zu normalen Schneiden nicht der Bohrungsdurchmesser und die Toleranz, sondern das gewünschte Schneidenendmaß angegeben. Q-Schneiden werden bei speziellen Bearbeitungsbedingungen eingesetzt, bei welchen definierte Standardtoleranzen nicht anwendbar sind.

Für Q-Schneiden muss eine „DRS“-Zeichnung erstellt werden. Die sprechende Standard-Bezeichnungsnummer kann hier nicht zum Einsatz kommen. Auch für Nenndurchmesser mit 3 Nachkommastellen oder Toleranzen die nicht dem ISO-Code entsprechen, muss eine zeichnungsgebundene DRS-Reibschneide gewählt werden.

Explanation of insert size order example

For orders with specifications of the bore tolerance, the diameter is defined by HORN standard. Depending on the size and tolerance, the finished diameter is approximately in the upper third of the tolerance range.

Examples standard insert designation:
DR.016.01200.H7.A1 HL3H
insert ground to $\varnothing 12,014 \pm 0,003$ mm

A Q-insert designation is selected for a specific insert dimension. In contrary to standard inserts where all tolerances refer to the bore tolerance, Q-inserts indicates the required insert diameter (target size). Q-inserts are recommended for special applications where standard tolerance ranges are not applicable.

A “DRS” drawing must be created for Q cutting edges. The corresponding standard designation number cannot be used here. A DRS reaming insert with a corresponding drawing must also be selected for nominal diameters with 3 decimal places or tolerances which do not comply with the ISO code.

F



Abbildung = rechtsschneidend
Picture = right hand cutting version

HM-Sorten
Carbide grades
▲ ab Lager
on stock
△ 4 Wochen
4 weeks

F

Bestellnummer Part number	Ds	Toleranz Tolerance	Größe Size	m_1	α	l_2	Z	HL3H
DR.016.01200.H7.A1	12	H7	016	0,25	45°	4,3	6	▲
DR.016.01300.H7.A1	13	H7	016	0,25	45°	4,3	6	▲
DR.016.01400.H7.A1	14	H7	016	0,25	45°	4,3	6	▲
DR.016.01500.H7.A1	15	H7	016	0,25	45°	4,3	6	▲
DR.019.01600.H7.A1	16	H7	019	0,25	45°	4,3	6	▲
DR.019.01700.H7.A1	17	H7	019	0,25	45°	4,3	6	▲
DR.019.01800.H7.A1	18	H7	019	0,25	45°	4,3	6	▲
DR.024.01900.H7.A1	19	H7	024	0,25	45°	4,3	6	▲
DR.024.02000.H7.A1	20	H7	024	0,25	45°	4,3	6	▲
DR.024.02100.H7.A1	21	H7	024	0,25	45°	4,3	6	▲
DR.024.02200.H7.A1	22	H7	024	0,25	45°	4,3	6	▲
DR.024.02300.H7.A1	23	H7	024	0,25	45°	4,3	6	▲
DR.029.02400.H7.A1	24	H7	029	0,3	45°	4,3	8	▲
DR.029.02500.H7.A1	25	H7	029	0,3	45°	4,3	8	▲
DR.029.02600.H7.A1	26	H7	029	0,3	45°	4,3	8	▲
DR.029.02700.H7.A1	27	H7	029	0,3	45°	4,3	8	▲
DR.029.02800.H7.A1	28	H7	029	0,3	45°	4,3	8	▲
DR.036.02900.H7.A1	29	H7	036	0,3	45°	4,3	8	▲
DR.036.03000.H7.A1	30	H7	036	0,3	45°	4,3	8	▲
DR.036.03100.H7.A1	31	H7	036	0,3	45°	4,3	8	▲
DR.036.03200.H7.A1	32	H7	036	0,3	45°	4,3	8	▲
DR.036.03300.H7.A1	33	H7	036	0,3	45°	4,3	8	△
DR.036.03400.H7.A1	34	H7	036	0,3	45°	4,3	8	▲
DR.036.03500.H7.A1	35	H7	036	0,3	45°	4,3	8	▲

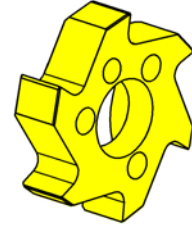
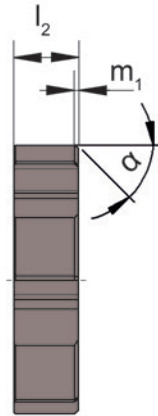
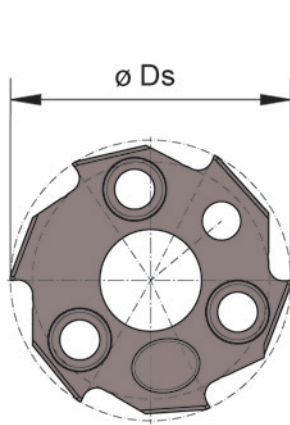
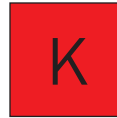
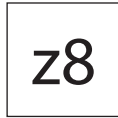
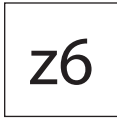
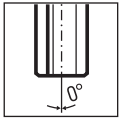
Empfehlungen für Schneidengeometrie und HM-Sorte kombiniert mit der geeigneten IK-Variante des Reibschafte, finden Sie in der Übersicht Grundauswahl
Recommendations for cutting geometry and carbide grade combined with the suitable IK variant of the reaming shank can be found in the basic selection overview

P	●
M	○
K	●
N	○
S	-
H	○



Abbildung = rechtsschneidend
Picture = right hand cutting version

▲ ab Lager
on stock

HM-Sorten
Carbide grades
Δ 4 Wochen
4 weeks

Bestellnummer Part number	Ds	Toleranz Tolerance	Größe Size	m_1	α	l_2	Z	HL3H
DR.016.01200.H7.B1	12	H7	016	0,54	25°	4,3	6	▲
DR.016.01300.H7.B1	13	H7	016	0,54	25°	4,3	6	▲
DR.016.01400.H7.B1	14	H7	016	0,54	25°	4,3	6	▲
DR.016.01500.H7.B1	15	H7	016	0,54	25°	4,3	6	▲
DR.019.01600.H7.B1	16	H7	019	0,54	25°	4,3	6	▲
DR.019.01700.H7.B1	17	H7	019	0,54	25°	4,3	6	▲
DR.019.01800.H7.B1	18	H7	019	0,54	25°	4,3	6	▲
DR.024.01900.H7.B1	19	H7	024	0,54	25°	4,3	6	▲
DR.024.02000.H7.B1	20	H7	024	0,54	25°	4,3	6	▲
DR.024.02100.H7.B1	21	H7	024	0,54	25°	4,3	6	▲
DR.024.02200.H7.B1	22	H7	024	0,54	25°	4,3	6	▲
DR.024.02300.H7.B1	23	H7	024	0,54	25°	4,3	6	▲
DR.029.02400.H7.B1	24	H7	029	0,64	25°	4,3	8	▲
DR.029.02500.H7.B1	25	H7	029	0,64	25°	4,3	8	▲
DR.029.02600.H7.B1	26	H7	029	0,64	25°	4,3	8	Δ
DR.029.02700.H7.B1	27	H7	029	0,64	25°	4,3	8	Δ
DR.029.02800.H7.B1	28	H7	029	0,64	25°	4,3	8	▲
DR.036.02900.H7.B1	29	H7	036	0,64	25°	4,3	8	▲
DR.036.03000.H7.B1	30	H7	036	0,64	25°	4,3	8	▲
DR.036.03100.H7.B1	31	H7	036	0,64	25°	4,3	8	Δ
DR.036.03200.H7.B1	32	H7	036	0,64	25°	4,3	8	▲
DR.036.03300.H7.B1	33	H7	036	0,64	25°	4,3	8	Δ
DR.036.03400.H7.B1	34	H7	036	0,64	25°	4,3	8	▲
DR.036.03500.H7.B1	35	H7	036	0,64	25°	4,3	8	▲

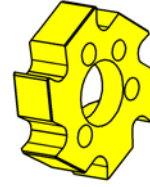
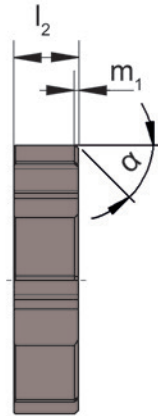
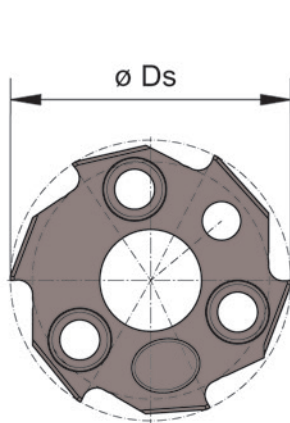
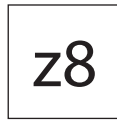
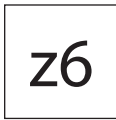
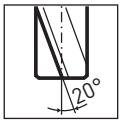
Empfehlungen für Schneidengeometrie und HM-Sorte kombiniert mit der geeigneten IK-Variante des Reibschafte, finden Sie in der Übersicht Grundauswahl
Recommendations for cutting geometry and carbide grade combined with the suitable IK variant of the reaming shank can be found in the basic selection overview

P	●
M	○
K	●
N	○
S	-
H	-





Abbildung = rechtsschneidend
Picture = right hand cutting version

▲ ab Lager
on stock

HM-Sorten
Carbide grades
Δ 4 Wochen
4 weeks

Bestellnummer Part number	Ds	Toleranz Tolerance	Größe Size	m ₁	α	l ₂	Z	H20
DR.016.01200.H7.A6	12	H7	016	0,25	45°	4,3	6	Δ
DR.016.01300.H7.A6	13	H7	016	0,25	45°	4,3	6	Δ
DR.016.01400.H7.A6	14	H7	016	0,25	45°	4,3	6	Δ
DR.016.01500.H7.A6	15	H7	016	0,25	45°	4,3	6	Δ
DR.019.01600.H7.A6	16	H7	019	0,25	45°	4,3	6	Δ
DR.019.01700.H7.A6	17	H7	019	0,25	45°	4,3	6	Δ
DR.019.01800.H7.A6	18	H7	019	0,25	45°	4,3	6	Δ
DR.024.01900.H7.A6	19	H7	024	0,25	45°	4,3	6	Δ
DR.024.02000.H7.A6	20	H7	024	0,25	45°	4,3	6	Δ
DR.024.02100.H7.A6	21	H7	024	0,25	45°	4,3	6	Δ
DR.024.02200.H7.A6	22	H7	024	0,25	45°	4,3	6	Δ
DR.024.02300.H7.A6	23	H7	024	0,25	45°	4,3	6	Δ
DR.029.02400.H7.A6	24	H7	029	0,3	45°	4,3	8	Δ
DR.029.02500.H7.A6	25	H7	029	0,3	45°	4,3	8	Δ
DR.029.02600.H7.A6	26	H7	029	0,3	45°	4,3	8	Δ
DR.029.02700.H7.A6	27	H7	029	0,3	45°	4,3	8	Δ
DR.029.02800.H7.A6	28	H7	029	0,3	45°	4,3	8	Δ
DR.036.02900.H7.A6	29	H7	036	0,3	45°	4,3	8	Δ
DR.036.03000.H7.A6	30	H7	036	0,3	45°	4,3	8	Δ
DR.036.03100.H7.A6	31	H7	036	0,3	45°	4,3	8	Δ
DR.036.03200.H7.A6	32	H7	036	0,3	45°	4,3	8	Δ
DR.036.03400.H7.A6	34	H7	036	0,3	45°	4,3	8	Δ
DR.036.03500.H7.A6	35	H7	36	0,3	45°	4,3	8	Δ

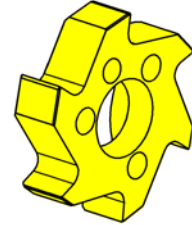
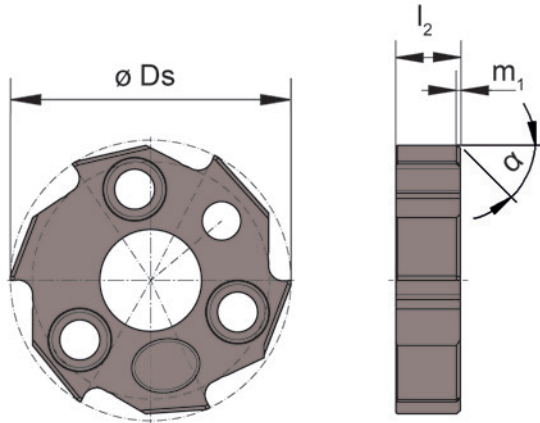
Empfehlungen für Schneidengeometrie und HM-Sorte finden Sie in den Technischen Hinweisen
For recommendations of cutting geometry and carbide grade please see technical instructions

P	●
M	-
K	○
N	-
S	-
H	-



z6

Cermet

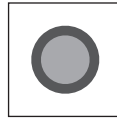

P

z8



Abbildung = rechtsschneidend
Picture = right hand cutting version

▲ ab Lager
on stock

HM-Sorten
Carbide grades
Δ 4 Wochen
4 weeks

Bestellnummer Part number	Ds	Toleranz Tolerance	Größe Size	m_1	α	l_2	Z	H20
DR.016.01200.H7.B6	12	H7	016	0,54	25°	4,3	6	Δ
DR.016.01300.H7.B6	13	H7	016	0,54	25°	4,3	6	Δ
DR.016.01400.H7.B6	14	H7	016	0,54	25°	4,3	6	Δ
DR.016.01500.H7.B6	15	H7	016	0,54	25°	4,3	6	Δ
DR.019.01600.H7.B6	16	H7	019	0,54	25°	4,3	6	Δ
DR.019.01700.H7.B6	17	H7	019	0,54	25°	4,3	6	Δ
DR.019.01800.H7.B6	18	H7	019	0,54	25°	4,3	6	Δ
DR.024.01900.H7.B6	19	H7	024	0,54	25°	4,3	6	Δ
DR.024.02000.H7.B6	20	H7	024	0,54	25°	4,3	6	Δ
DR.024.02100.H7.B6	21	H7	024	0,54	25°	4,3	6	Δ
DR.024.02200.H7.B6	22	H7	024	0,54	25°	4,3	6	Δ
DR.024.02300.H7.B6	23	H7	024	0,54	25°	4,3	6	Δ
DR.029.02400.H7.B6	24	H7	029	0,64	25°	4,3	8	Δ
DR.029.02500.H7.B6	25	H7	029	0,64	25°	4,3	8	Δ
DR.029.02600.H7.B6	26	H7	029	0,64	25°	4,3	8	Δ
DR.029.02700.H7.B6	27	H7	029	0,64	25°	4,3	8	Δ
DR.029.02800.H7.B6	28	H7	029	0,64	25°	4,3	8	Δ
DR.036.02900.H7.B6	29	H7	036	0,64	25°	4,3	8	Δ
DR.036.03000.H7.B6	30	H7	036	0,64	25°	4,3	8	Δ
DR.036.03200.H7.B6	32	H7	036	0,64	25°	4,3	8	Δ
DR.036.03400.H7.B6	34	H7	036	0,64	25°	4,3	8	Δ
DR.036.03500.H7.B6	35	H7	036	0,64	25°	4,3	8	Δ

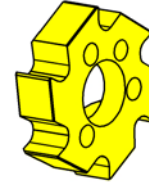
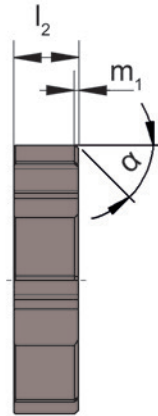
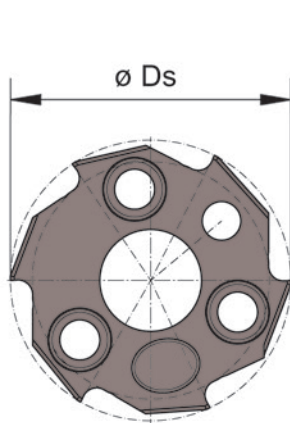
Empfehlungen für Schneidengeometrie und HM-Sorte finden Sie in den Technischen Hinweisen
For recommendations of cutting geometry and carbide grade please see technical instructions

P	●
M	-
K	○
N	-
S	-
H	-



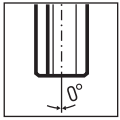

z6

z8

N



Abbildung = rechtsschneidend
Picture = right hand cutting version

▲ ab Lager
on stock

HM-Sorten
Carbide grades
Δ 4 Wochen
4 weeks

F

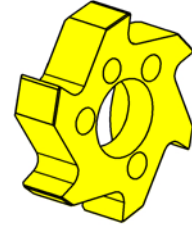
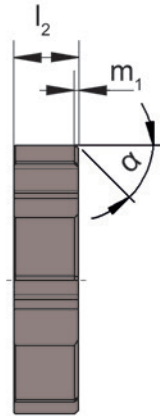
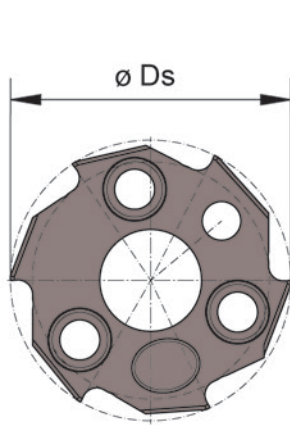
Bestellnummer Part number	Ds	Toleranz Tolerance	Größe Size	m_1	α	l_2	Z	DT2H
DR.016.01200.H7.A7	12	H7	016	0,25	45°	4,3	6	Δ
DR.016.01300.H7.A7	13	H7	016	0,25	45°	4,3	6	Δ
DR.016.01400.H7.A7	14	H7	016	0,25	45°	4,3	6	Δ
DR.016.01500.H7.A7	15	H7	016	0,25	45°	4,3	6	Δ
DR.019.01600.H7.A7	16	H7	019	0,25	45°	4,3	6	Δ
DR.019.01700.H7.A7	17	H7	019	0,25	45°	4,3	6	Δ
DR.019.01800.H7.A7	18	H7	019	0,25	45°	4,3	6	Δ
DR.024.01900.H7.A7	19	H7	024	0,25	45°	4,3	6	Δ
DR.024.02000.H7.A7	20	H7	024	0,25	45°	4,3	6	Δ
DR.024.02100.H7.A7	21	H7	024	0,25	45°	4,3	6	Δ
DR.024.02200.H7.A7	22	H7	024	0,25	45°	4,3	6	Δ
DR.024.02300.H7.A7	23	H7	024	0,25	45°	4,3	6	Δ
DR.029.02400.H7.A7	24	H7	029	0,3	45°	4,3	8	Δ
DR.029.02500.H7.A7	25	H7	029	0,3	45°	4,3	8	Δ
DR.029.02600.H7.A7	26	H7	029	0,3	45°	4,3	8	Δ
DR.029.02700.H7.A7	27	H7	029	0,3	45°	4,3	8	Δ
DR.029.02800.H7.A7	28	H7	029	0,3	45°	4,3	8	Δ
DR.036.02900.H7.A7	29	H7	036	0,3	45°	4,3	8	Δ
DR.036.03000.H7.A7	30	H7	036	0,3	45°	4,3	8	Δ
DR.036.03100.H7.A7	31	H7	036	0,3	45°	4,3	8	Δ
DR.036.03200.H7.A7	32	H7	036	0,3	45°	4,3	8	Δ
DR.036.03400.H7.A7	34	H7	036	0,3	45°	4,3	8	Δ
DR.036.03500.H7.A7	35	H7	036	0,3	45°	4,3	8	Δ

Empfehlungen für Schneidengeometrie und HM-Sorte kombiniert mit der geeigneten IK-Variante des Reibschaffts, finden Sie in der Übersicht Grundauswahl
Recommendations for cutting geometry and carbide grade combined with the suitable IK variant of the reaming shank can be found in the basic selection overview

P	-
M	-
K	-
N	●
S	-
H	-



Abbildung = rechtsschneidend
Picture = right hand cutting version

▲ ab Lager
on stock

HM-Sorten
Carbide grades
Δ 4 Wochen
4 weeks

Bestellnummer Part number	Ds	Toleranz Tolerance	Größe Size	m_1	α	l_2	Z	DT2H
DR.016.01200.H7.B7	12	H7	016	0,54	25°	4,3	6	Δ
DR.016.01300.H7.B7	13	H7	016	0,54	25°	4,3	6	Δ
DR.016.01400.H7.B7	14	H7	016	0,54	25°	4,3	6	Δ
DR.016.01500.H7.B7	15	H7	016	0,54	25°	4,3	6	Δ
DR.019.01600.H7.B7	16	H7	019	0,54	25°	4,3	6	Δ
DR.019.01700.H7.B7	17	H7	019	0,54	25°	4,3	6	Δ
DR.019.01800.H7.B7	18	H7	019	0,54	25°	4,3	6	Δ
DR.024.01900.H7.B7	19	H7	024	0,54	25°	4,3	6	Δ
DR.024.02000.H7.B7	20	H7	024	0,54	25°	4,3	6	Δ
DR.024.02100.H7.B7	21	H7	024	0,54	25°	4,3	6	Δ
DR.024.02200.H7.B7	22	H7	024	0,54	25°	4,3	6	Δ
DR.024.02300.H7.B7	23	H7	024	0,54	25°	4,3	6	Δ
DR.029.02400.H7.B7	24	H7	029	0,64	25°	4,3	8	Δ
DR.029.02500.H7.B7	25	H7	029	0,64	25°	4,3	8	Δ
DR.029.02600.H7.B7	26	H7	029	0,64	25°	4,3	8	Δ
DR.029.02700.H7.B7	27	H7	029	0,64	25°	4,3	8	Δ
DR.029.02800.H7.B7	28	H7	029	0,64	25°	4,3	8	Δ
DR.036.02900.H7.B7	29	H7	036	0,64	25°	4,3	8	Δ
DR.036.03000.H7.B7	30	H7	036	0,64	25°	4,3	8	Δ
DR.036.03100.H7.B7	31	H7	036	0,64	25°	4,3	8	Δ
DR.036.03200.H7.B7	32	H7	036	0,64	25°	4,3	8	Δ
DR.036.03400.H7.B7	34	H7	036	0,64	25°	4,3	8	Δ
DR.036.03500.H7.B7	35	H7	036	0,64	25°	4,3	8	Δ

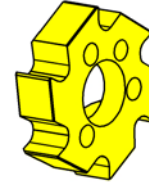
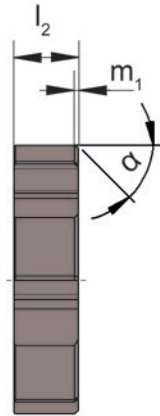
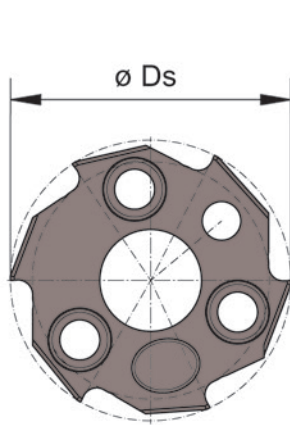
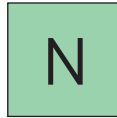
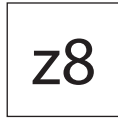
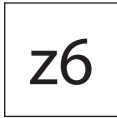
Empfehlungen für Schneidengeometrie und HM-Sorte kombiniert mit der geeigneten IK-Variante des Reibschaffts, finden Sie in der Übersicht Grundauswahl
Recommendations for cutting geometry and carbide grade combined with the suitable IK variant of the reaming shank can be found in the basic selection overview

P	-
M	-
K	-
N	●
S	-
H	-



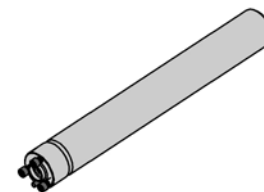
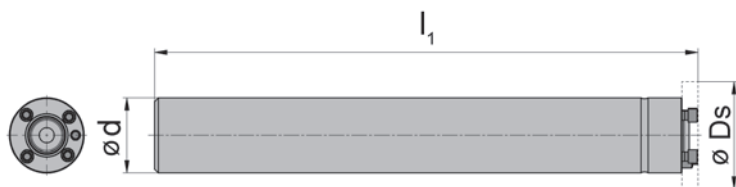
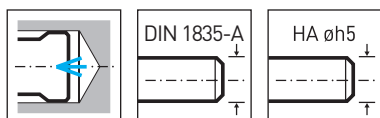

Innere Kühlmittelzufuhr
Through coolant

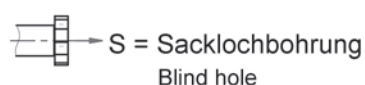

F

Bestellnummer Part number	Ds _{min}	Ds _{max}	l ₁	d	Kühlung Coolant	Größe Size
MDR.016.ST10.100.A.S	11,9	15,6	100	10	S	016
MDR.016.HM10.160.A.S	11,9	15,6	160	10	S	016
MDR.016.ST10.160.A.S	11,9	15,6	160	10	S	016
MDR.019.ST12.115.A.S	15,601	18,6	115	12	S	019
MDR.019.HM12.185.A.S	15,601	18,6	185	12	S	019
MDR.019.ST12.185.A.S	15,601	18,6	185	12	S	019
MDR.024.ST16.128.A.S	18,601	23,6	128	16	S	024
MDR.024.HM16.208.A.S	18,601	23,6	208	16	S	024
MDR.024.ST16.208.A.S	18,601	23,6	208	16	S	024
MDR.029.ST20.145.A.S	23,601	28,6	145	20	S	029
MDR.029.HM20.240.A.S	23,601	28,6	240	20	S	029
MDR.029.ST20.240.A.S	23,601	28,6	240	20	S	029
MDR.036.ST25.170.A.S	28,601	35,6	170	25	S	036
MDR.036.HM25.274.A.S	28,601	35,6	274	25	S	036
MDR.036.ST25.274.A.S	28,601	35,6	274	25	S	036

Schaftmaterial: HM = Hartmetall ST = Stahl
Material of shank: HM = Carbide ST = Steel

1 Satz Schrauben, 1 Torx-Schlüssel im Lieferumfang enthalten
1 Set of screws, 1 Torx wrench - no separate order required!

Ersatzteile

Spare Parts

Reibschaft Reaming insert holder	Schraube Screw
MDR.016...-019...	C009000
MDR.024...-036...	C009001

Reibschaft

Reaming insert holder

MDR

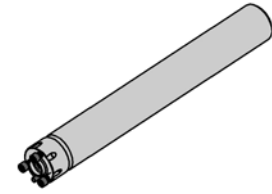
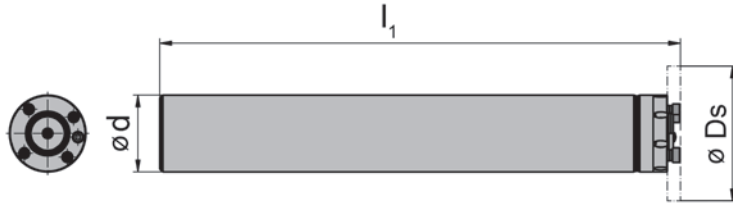
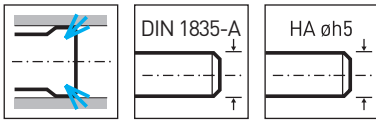

Innere Kühlmittelzufuhr
Through coolant



D = Durchgangsbohrung
Through hole

Bestellnummer Part number	Ds _{min}	Ds _{max}	l ₁	d	Kühlung Coolant	Größe Size
MDR.016.ST10.100.A.D	11,9	15,6	100	10	D	016
MDR.016.HM10.160.A.D	11,9	15,6	160	10	D	016
MDR.016.ST10.160.A.D	11,9	15,6	160	10	D	016
MDR.019.ST12.115.A.D	15,601	18,6	115	12	D	019
MDR.019.HM12.185.A.D	15,601	18,6	185	12	D	019
MDR.019.ST12.185.A.D	15,601	18,6	185	12	D	019
MDR.024.ST16.128.A.D	18,601	23,6	128	16	D	024
MDR.024.HM16.208.A.D	18,601	23,6	208	16	D	024
MDR.024.ST16.208.A.D	18,601	23,6	208	16	D	024
MDR.029.ST20.145.A.D	23,601	28,6	145	20	D	029
MDR.029.HM20.240.A.D	23,601	28,6	240	20	D	029
MDR.029.ST20.240.A.D	23,601	28,6	240	20	D	029
MDR.036.ST25.170.A.D	28,601	35,6	170	25	D	036
MDR.036.HM25.274.A.D	28,601	35,6	274	25	D	036
MDR.036.ST25.274.A.D	28,601	35,6	274	25	D	036

Schaftmaterial: HM = Hartmetall ST = Stahl
Material of shank: HM = Carbide ST = Steel

1 Satz Schrauben, 1 Torx-Schlüssel im Lieferumfang enthalten
1 Set of screws, 1 Torx wrench - no separate order required!

Ersatzteile

Spare Parts

Reibschaft Reaming insert holder	Schraube Screw
MDR.016...-019...	C009000
MDR. 024...-036...	C009001

F

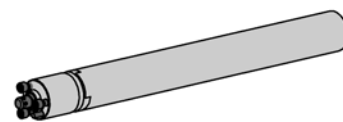
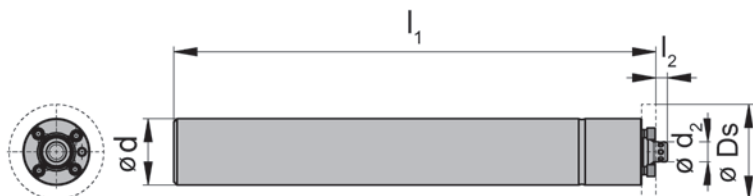
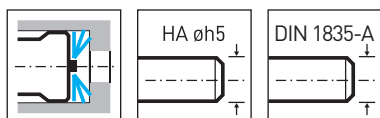

Innere Kühlmittelzufuhr
Through coolant



R = Rückspülkühlung
Backwash cooling

F

Bestellnummer Part number	Ds _{min}	Ds _{max}	l ₂	l ₁	d	d ₂	Kühlung Coolant	Größe Size
MDR.016.HM10.160.A.R	11,9	15,6	2	160	10	2,5	R	016
MDR.016.ST10.100.A.R	11,9	15,6	2	100	10	2,5	R	016
MDR.016.ST10.160.A.R	11,9	15,6	2	160	10	2,5	R	016
MDR.019.HM12.185.A.R	15,601	18,6	2,5	185	12	3,5	R	019
MDR.019.ST12.115.A.R	15,601	18,6	2,5	115	12	3,5	R	019
MDR.019.ST12.185.A.R	15,601	18,6	2,5	185	12	3,5	R	019
MDR.024.HM16.208.A.R	18,601	23,6	3	208	16	5	R	024
MDR.024.ST16.128.A.R	18,601	23,6	3	128	16	5	R	024
MDR.024.ST16.208.A.R	18,601	23,6	3	208	16	5	R	024
MDR.029.HM20.240.A.R	23,601	28,6	3,5	240	20	6	R	029
MDR.029.ST20.145.A.R	23,601	28,6	3,5	145	20	6	R	029
MDR.029.ST20.240.A.R	23,601	28,6	3,5	240	20	6	R	029
MDR.036.HM25.274.A.R	28,601	35,6	4	74	25	8	R	036
MDR.036.ST25.170.A.R	28,601	35,6	4	170	25	8	R	036
MDR.036.ST25.274.A.R	28,601	35,6	4	274	25	8	R	036

Schaftmaterial: HM = Hartmetall ST = Stahl
Material of shank: HM = Carbide ST = Steel

1 Satz Schrauben, 1 Torx-Schlüssel im Lieferumfang enthalten
1 Set of screws, 1 Torx wrench - no separate order required!

Ersatzteile

Spare Parts

Reibschaft Reaming insert holder	Schraube Screw
MDR.016...-019...	C009000
MDR. 024...-036...	C009001

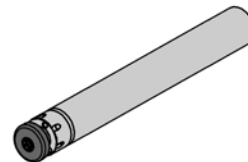
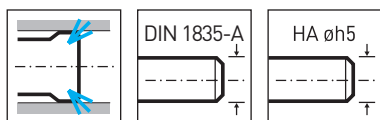

Innere Kühlmittelzufuhr
Through coolant

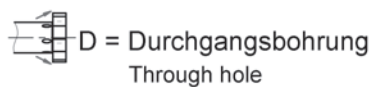

Bestellnummer Part number	Ds _{min}	Ds _{max}	l ₂	l ₁	d	d ₂	Kühlung Coolant	Größe Size
MDR.016.ST10.100.A.D.Z	11,9	15,6	2,5	100	10	9,8	D	016
MDR.016.HM10.160.A.D.Z	11,9	15,6	2,5	160	10	9,8	D	016
MDR.016.ST10.160.A.D.Z	11,9	15,6	2,5	160	10	9,8	D	016
MDR.019.ST12.115.A.D.Z	15,601	18,6	3	115	12	11,8	D	019
MDR.019.HM12.185.A.D.Z	15,601	18,6	3	185	12	11,8	D	019
MDR.019.ST12.185.A.D.Z	15,601	18,6	3	185	12	11,8	D	019
MDR.024.ST16.128.A.D.Z	18,601	23,6	4	128	16	15,8	D	024
MDR.024.HM16.208.A.D.Z	18,601	23,6	4	208	16	15,8	D	024
MDR.024.ST16.208.A.D.Z	18,601	23,6	4	208	16	15,8	D	024
MDR.029.ST20.145.A.D.Z	23,601	28,6	4	145	20	24,5	D	029
MDR.029.HM20.240.A.D.Z	23,601	28,6	4	240	20	24,5	D	029
MDR.029.ST20.240.A.D.Z	23,601	28,6	4	240	20	24,5	D	029
MDR.036.ST25.170.A.D.Z	28,601	35,6	4	170	25	24,5	D	036
MDR.036.HM25.274.A.D.Z	28,601	35,6	4	274	25	24,5	D	036
MDR.036.ST25.274.A.D.Z	28,601	35,6	4	274	25	24,5	D	036

mit zentraler Spannschraube
with central clamping screw

Schaftmaterial: HM = Hartmetall ST = Stahl
Material of shank: HM = Carbide ST = Steel

1 Satz Schrauben, 1 Torx-Schlüssel im Lieferumfang enthalten
1 Set of screws, 1 Torx wrench - no separate order required!

Ersatzteile

Spare Parts

Reibschaft Reaming insert holder	Schraube Screw	Torx-Schlüssel Torx Wrench
MDR.016...Z	C009022	T15Q
MDR.019...Z	C009023	T20Q
MDR.024...-029...Z	C009024	T30Q
MDR.036...Z	C009025	T30Q

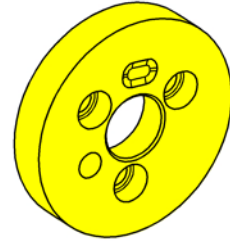
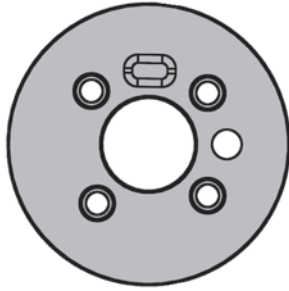

F

Bestellnummer Part number	Größe Size
DR.016.ROCD	016
DR.019.ROCD	019
DR.024.ROCD	024
DR.029.ROCD	029
DR.036.ROCD	036



F

Systemgröße DR044 - DR141

System Size DR044 - DR141



Modulares System für Ø 35,601 - 140,600 mm

Modular System for Ø 35,601 - 140,600 mm

Aufnahme mit Beta-Modul

Adaptor with Beta-Module

Kapitel Systemaufnahme URMA

Chapter System Adaptor URMA

Ausgleichshalter

Balancing shank

BD

BH

BT

VDR

zylindrisch
cylindrical

VDR

direkt
direct

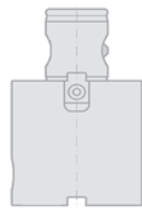
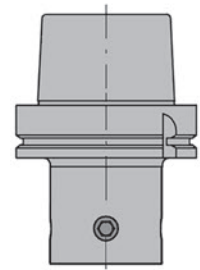
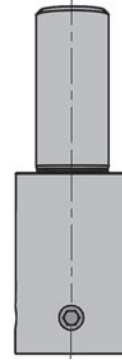
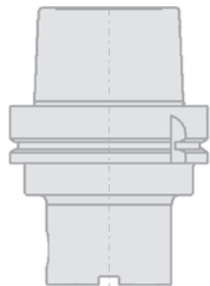
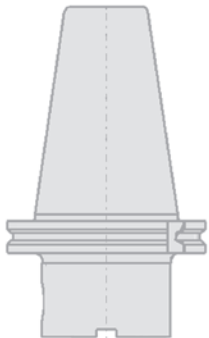

B13

Verlängerung

Extension

Beta-Modul

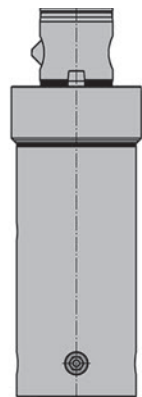

VDR

Ausgleichshalter

Balancing shank

Beta-Modul

MDR

Reibschaft

Reaming insert holder

DR

Schneidplatte

Insert

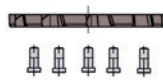
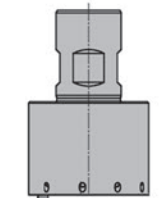

Spannschrauben für Platte
Screws for insert

Schraube für Halter
Screw for holder



F

Bestellbeispiel Reibschneide

Ordering example of reaming inserts



Bestellbeispiel mit ISO-Toleranzangaben

Ordering example with ISO tolerance

DR.044.03561.H7.A1 HL3H

DR

DR Systembezeichnung
DR System designation

044

Plattensitzgröße
Seating size

35,61

Durchmesser in mm
Diameter in mm

H7

Toleranz
Tolerance

A1

Schneidengeometrie
Cutting geometry

HL3H

HM-Sorte
Carbide grade

Erklärung Schneidenmaß

Bei Bestellungen mit Angaben der Bohrungstoleranz wird der Durchmesser durch HORN-Standard definiert. Der Fertigdurchmesser liegt, je nach Größe und Toleranz, etwa im oberen Drittel des Toleranzfeldes.

Beispiel Standard Schneidenbezeichnung:
DR.044.03561.H7.A1 HL3H
Schneide gefertigt auf $\varnothing 35,63 \pm 0,003$ mm

Wenn ein spezifisches Schneidenmaß benötigt wird, muss eine Q-Schneide gewählt werden. Bei Q-Schneiden (Festmaßschneide) wird im Gegensatz zu normalen Schneiden nicht der Bohrungsdurchmesser und die Toleranz, sondern das gewünschte Schneidenendmaß angegeben. Q-Schneiden werden bei speziellen Bearbeitungsbedingungen eingesetzt, bei welchen definierte Standardtoleranzen nicht anwendbar sind.

Für Q-Schneiden muss eine „DRS“-Zeichnung erstellt werden. Die sprechende Standard-Bezeichnungsnummer kann hier nicht zum Einsatz kommen. Auch für Nenndurchmesser mit 3 Nachkommastellen oder Toleranzen die nicht dem ISO-Code entsprechen, muss eine zeichnungsgebundene DRS-Reibschneide gewählt werden.

Explanation of insert size order example

For orders with specifications of the bore tolerance, the diameter is defined by HORN standard. Depending on the size and tolerance, the finished diameter is approximately in the upper third of the tolerance range.

Examples standard insert designation:
DR.044.03561.H7.A1 HL3H
insert ground to $\varnothing 35,63 \pm 0,003$ mm

A Q-insert designation is selected for a specific insert dimension. In contrary to standard inserts where all tolerances refer to the bore tolerance, Q-inserts indicates the required insert diameter (target size). Q-inserts are recommended for special applications where standard tolerance ranges are not applicable.

A “DRS” drawing must be created for Q cutting edges. The corresponding standard designation number cannot be used here. A DRS reaming insert with a corresponding drawing must also be selected for nominal diameters with 3 decimal places or tolerances which do not comply with the ISO code.

F



Abbildung = rechtsschneidend
Picture = right hand cutting version

HM-Sorten
Carbide grades
▲ ab Lager
on stock
Δ 4 Wochen
4 weeks

Bestellnummer Part number	Ds	Toleranz Tolerance	Größe Size	m_1	α	l_2	Z	HL3H
DR.044.03600.H7.A1	36	H7	044	0,35	45°	4,3	8	Δ
DR.044.03700.H7.A1	37	H7	044	0,35	45°	4,3	8	▲
DR.044.03800.H7.A1	38	H7	044	0,35	45°	4,3	8	▲
DR.044.03900.H7.A1	39	H7	044	0,35	45°	4,3	8	Δ
DR.044.04000.H7.A1	40	H7	044	0,35	45°	4,3	8	▲
DR.044.04100.H7.A1	41	H7	044	0,35	45°	4,3	8	Δ
DR.044.04200.H7.A1	42	H7	044	0,35	45°	4,3	8	▲
DR.044.04300.H7.A1	43	H7	044	0,35	45°	4,3	8	▲
DR.052.04400.H7.A1	44	H7	052	0,35	45°	4,3	10	▲
DR.052.04500.H7.A1	45	H7	052	0,35	45°	4,3	10	▲
DR.052.04600.H7.A1	46	H7	052	0,35	45°	4,3	10	▲
DR.052.04700.H7.A1	47	H7	052	0,35	45°	4,3	10	▲
DR.052.04800.H7.A1	48	H7	052	0,35	45°	4,3	10	Δ
DR.052.04900.H7.A1	49	H7	052	0,35	45°	4,3	10	▲
DR.052.05000.H7.A1	50	H7	052	0,35	45°	4,3	10	▲
DR.061.05200.H7.A1	52	H7	061	0,35	45°	4,3	10	▲
DR.061.05500.H7.A1	55	H7	061	0,35	45°	4,3	10	▲
DR.061.06000.H7.A1	60	H7	061	0,35	45°	4,3	10	Δ
DR.081.06500.H7.A1	65	H7	081	0,4	45°	4,3	12	▲
DR.081.06800.H7.A1	68	H7	081	0,4	45°	4,3	12	Δ
DR.081.07000.H7.A1	70	H7	081	0,4	45°	4,3	12	▲
DR.081.07500.H7.A1	75	H7	081	0,4	45°	4,3	12	▲
DR.081.08000.H7.A1	80	H7	081	0,4	45°	4,3	12	▲
DR.101.08500.H7.A1	85	H7	101	0,45	45°	4,3	12	▲
DR.101.09000.H7.A1	90	H7	101	0,45	45°	4,3	12	▲
DR.101.09500.H7.A1	95	H7	101	0,45	45°	4,3	12	Δ
DR.101.10000.H7.A1	100	H7	101	0,45	45°	4,3	12	▲
DR.121.11000.H7.A1	110	H7	121	0,6	45°	5,3	12	Δ
DR.121.12000.H7.A1	120	H7	121	0,6	45°	5,3	12	Δ
DR.141.13000.H7.A1	130	H7	141	0,6	45°	5,3	12	Δ
DR.141.14000.H7.A1	140	H7	141	0,6	45°	5,3	12	Δ

Empfehlungen für Schneidengeometrie und HM-Sorte kombiniert mit der geeigneten IK-Variante des Reibschafis, finden Sie in der Übersicht Grundauswahl
Recommendations for cutting geometry and carbide grade combined with the suitable IK variant of the reaming shank can be found in the basic selection overview

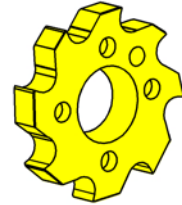
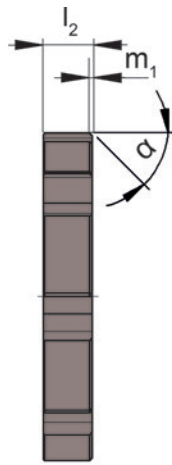
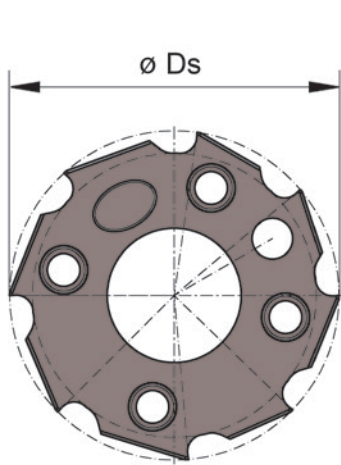
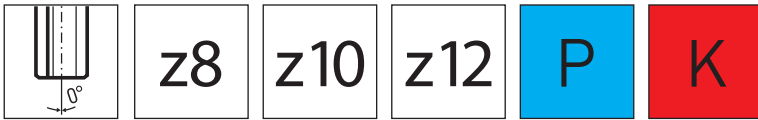
P	●
M	○
K	●
N	○
S	-
H	○



z8

z10

z12

P

K



Abbildung = rechtsschneidend
Picture = right hand cutting version

HM-Sorten
Carbide grades

▲ ab Lager
on stock

Δ 4 Wochen
4 weeks

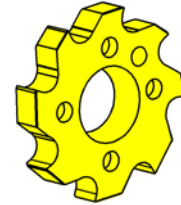
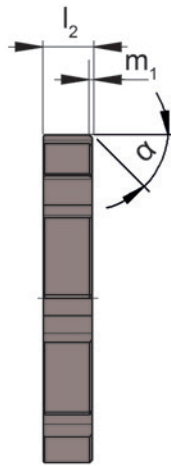
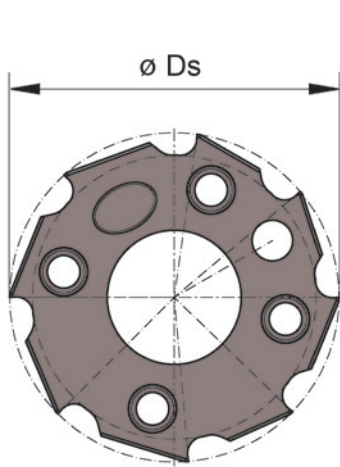
Bestellnummer Part number	Ds	Toleranz Tolerance	Größe Size	m_1	α	l_2	Z	HL3H
DR.044.03600.H7.B1	36	H7	044	0,75	25°	4,3	8	▲
DR.044.03700.H7.B1	37	H7	044	0,75	25°	4,3	8	Δ
DR.044.03800.H7.B1	38	H7	044	0,75	25°	4,3	8	▲
DR.044.03900.H7.B1	39	H7	044	0,75	25°	4,3	8	Δ
DR.044.04000.H7.B1	40	H7	044	0,75	25°	4,3	8	▲
DR.044.04100.H7.B1	41	H7	044	0,75	25°	4,3	8	Δ
DR.044.04200.H7.B1	42	H7	044	0,75	25°	4,3	8	▲
DR.044.04300.H7.B1	43	H7	044	0,75	25°	4,3	8	Δ
DR.052.04400.H7.B1	44	H7	052	0,75	25°	4,3	10	Δ
DR.052.04500.H7.B1	45	H7	052	0,75	25°	4,3	10	▲
DR.052.04600.H7.B1	46	H7	052	0,75	25°	4,3	10	▲
DR.052.04700.H7.B1	47	H7	052	0,75	25°	4,3	10	▲
DR.052.04800.H7.B1	48	H7	052	0,75	25°	4,3	10	▲
DR.052.04900.H7.B1	49	H7	052	0,75	25°	4,3	10	Δ
DR.052.05000.H7.B1	50	H7	052	0,75	25°	4,3	10	▲
DR.061.05200.H7.B1	52	H7	061	0,75	25°	4,3	10	▲
DR.061.05500.H7.B1	55	H7	061	0,75	25°	4,3	10	Δ
DR.061.06000.H7.B1	60	H7	061	0,75	25°	4,3	10	▲
DR.081.06500.H7.B1	65	H7	081	0,86	25°	4,3	12	▲
DR.081.06800.H7.B1	68	H7	081	0,86	25°	4,3	12	Δ
DR.081.07000.H7.B1	70	H7	081	0,86	25°	4,3	12	Δ
DR.081.07500.H7.B1	75	H7	081	0,86	25°	4,3	12	Δ
DR.081.08000.H7.B1	80	H7	081	0,86	25°	4,3	12	Δ
DR.101.08500.H7.B1	85	H7	101	0,97	25°	4,3	12	Δ
DR.101.09000.H7.B1	90	H7	101	0,97	25°	4,3	12	Δ
DR.101.09500.H7.B1	95	H7	101	0,97	25°	4,3	12	Δ
DR.101.10000.H7.B1	100	H7	101	0,97	25°	4,3	12	Δ
DR.121.11000.H7.B1	110	H7	121	1,29	25°	5,3	12	Δ
DR.121.12000.H7.B1	120	H7	121	1,29	25°	5,3	12	Δ
DR.141.13000.H7.B1	130	H7	141	1,29	25°	5,3	12	Δ
DR.141.14000.H7.B1	140	H7	141	1,29	25°	5,3	12	Δ

Empfehlungen für Schneidengeometrie und HM-Sorte kombiniert mit der geeigneten IK-Variante des ReibschafTs, finden Sie in der Übersicht Grundauswahl
Recommendations for cutting geometry and carbide grade combined with the suitable IK variant of the reaming shank can be found in the basic selection overview

P	●
M	○
K	●
N	○
S	-
H	-



Abbildung = rechtsschneidend
Picture = right hand cutting version

▲ ab Lager
on stock

HM-Sorten
Carbide grades
Δ 4 Wochen
4 weeks

Bestellnummer Part number	Ds	Toleranz Tolerance	Größe Size	m_1	α	l_2	Z	H20
DR.044.03600.H7.A6	36	H7	044	0,35	45°	4,3	8	Δ
DR.044.04000.H7.A6	40	H7	044	0,35	45°	4,3	8	Δ
DR.044.04200.H7.A6	42	H7	044	0,35	45°	4,3	8	Δ
DR.052.04500.H7.A6	45	H7	052	0,35	45°	4,3	10	Δ
DR.052.05000.H7.A6	50	H7	052	0,35	45°	4,3	10	Δ

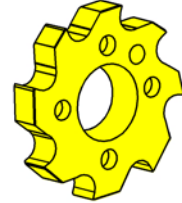
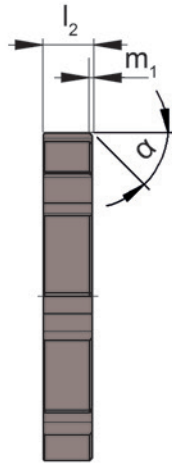
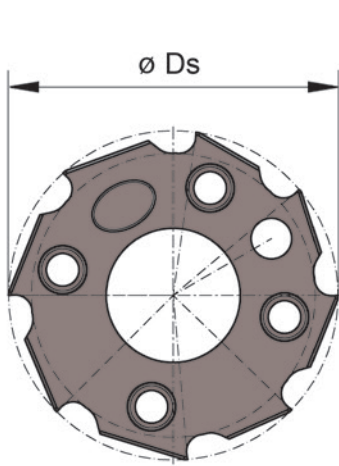
Empfehlungen für Schneidengeometrie und HM-Sorte finden Sie in den Technischen Hinweisen
For recommendations of cutting geometry and carbide grade please see technical instructions

P	●
M	-
K	○
N	-
S	-
H	-



Abbildung = rechtsschneidend
Picture = right hand cutting version

▲ ab Lager
on stock

HM-Sorten
Carbide grades
Δ 4 Wochen
4 weeks

Bestellnummer Part number	Ds	Toleranz Tolerance	Größe Size	m_1	α	l_2	Z	H20
DR.044.03600.H7.B6	36	H7	044	0,75	25°	4,3	8	Δ
DR.044.04000.H7.B6	40	H7	044	0,75	25°	4,3	8	Δ
DR.044.04200.H7.B6	42	H7	044	0,75	25°	4,3	8	Δ
DR.052.04500.H7.B6	45	H7	052	0,75	25°	4,3	10	Δ
DR.052.05000.H7.B6	50	H7	052	0,75	25°	4,3	10	Δ

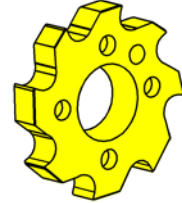
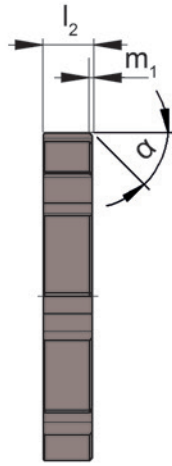
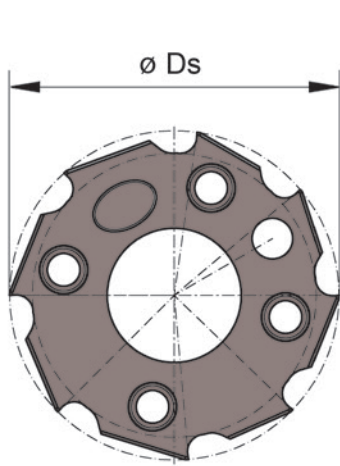
Empfehlungen für Schneidengeometrie und HM-Sorte finden Sie in den Technischen Hinweisen
For recommendations of cutting geometry and carbide grade please see technical instructions

P	●
M	-
K	○
N	-
S	-
H	-



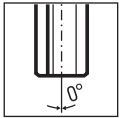

z8

z10

N

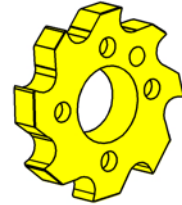
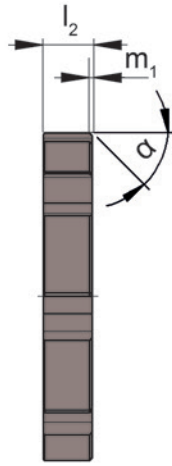
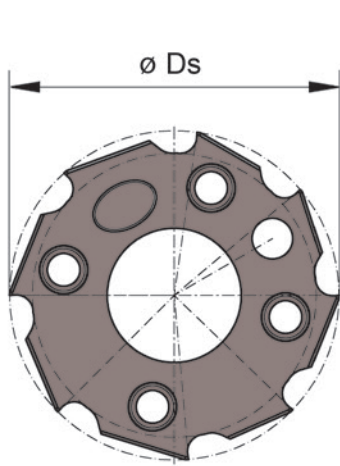

F

Abbildung = rechtsschneidend
Picture = right hand cutting version

▲ ab Lager
on stock

HM-Sorten
Carbide grades
Δ 4 Wochen
4 weeks

Bestellnummer Part number	Ds	Toleranz Tolerance	Größe Size	m_1	α	l_2	Z	DT2H
DR.044.03600.H7.A7	36	H7	044	0,35	45°	4,3	8	Δ
DR.044.04000.H7.A7	40	H7	044	0,35	45°	4,3	8	Δ
DR.044.04200.H7.A7	42	H7	044	0,35	45°	4,3	8	Δ
DR.052.04500.H7.A7	45	H7	052	0,35	45°	4,3	10	Δ
DR.052.05000.H7.A7	50	H7	052	0,35	45°	4,3	10	Δ

Empfehlungen für Schneidengeometrie und HM-Sorte kombiniert mit der geeigneten IK-Variante des Reibschafts, finden Sie in der Übersicht Grundauswahl
Recommendations for cutting geometry and carbide grade combined with the suitable IK variant of the reaming shank can be found in the basic selection overview

P	-
M	-
K	-
N	●
S	-
H	-



z8

z10

N



Abbildung = rechtsschneidend
Picture = right hand cutting version

▲ ab Lager
on stock

HM-Sorten
Carbide grades
Δ 4 Wochen
4 weeks

Bestellnummer Part number	Ds	Toleranz Tolerance	Größe Size	m_1	α	l_2	Z	DT2H
DR.044.03600.H7.B7	36	H7	044	0,75	25°	4,3	8	Δ
DR.044.04000.H7.B7	40	H7	044	0,75	25°	4,3	8	Δ
DR.044.04200.H7.B7	42	H7	044	0,75	25°	4,3	8	Δ
DR.052.04500.H7.B7	45	H7	052	0,75	25°	4,3	10	Δ
DR.052.05000.H7.B7	50	H7	052	0,75	25°	4,3	10	Δ

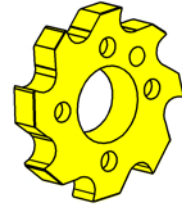
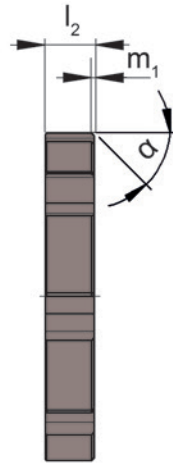
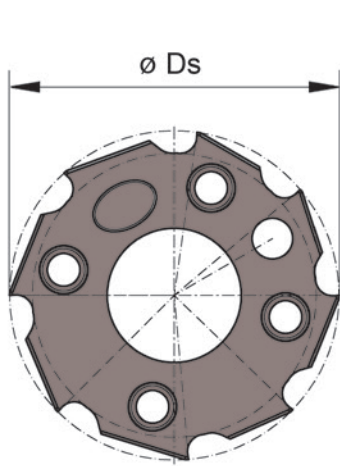
Empfehlungen für Schneidengeometrie und HM-Sorte kombiniert mit der geeigneten IK-Variante des Reibschafts, finden Sie in der Übersicht Grundauswahl
Recommendations for cutting geometry and carbide grade combined with the suitable IK variant of the reaming shank can be found in the basic selection overview

P	-
M	-
K	-
N	●
S	-
H	-



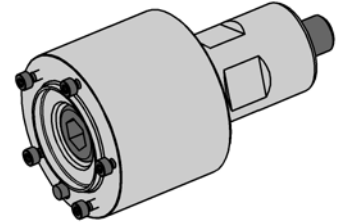
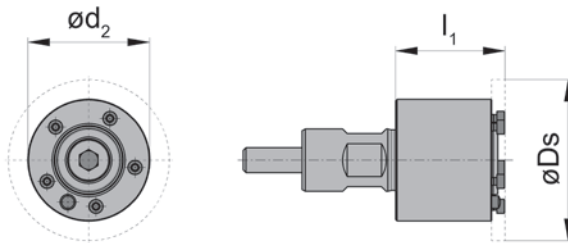
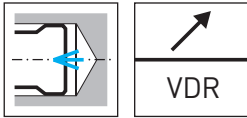

Innere Kühlmittelzufuhr
Through coolant supply

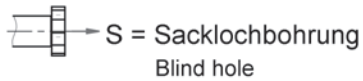

F

Bestellnummer Part number	$D_{s_{min}}$	$D_{s_{max}}$	l_1	d_2	Kühlung Coolant	Größe Size
MDR.044.32.30.V.S	35,601	43,6	30	32	S	044
MDR.052.39.35.V.S	43,601	51,6	35	39	S	052
MDR.061.46.40.V.S	51,601	60,6	40	46	S	061
MDR.081.56.50.V.S	60,601	80,6	50	56	S	081
MDR.101.76.60.V.S	80,601	100,6	60	76	S	101
MDR.121.76.60.V.S	100,601	120,6	60	76	S	121
MDR.141.76.60.V.S	120,601	140,6	60	76	S	141

1 Satz Schrauben, 1 Torx-Schlüssel im Lieferumfang enthalten
1 Set of screws, 1 Torx wrench - no separate order required!

Ersatzteile
Spare Parts

Reibschaft Reaming insert holder	Schraube Screw	Zylinderschraube Cylindrical screw
MDR.044.32.30.V.S	C009002	C002623B
MDR.052.39.35.V.S	C009002	C002638B
MDR.061.46.40.V.S	C009002	C002426B
MDR.081.56.50.V.S	C009004	C002637B
MDR.101-141...V.S	C009004	C002431B

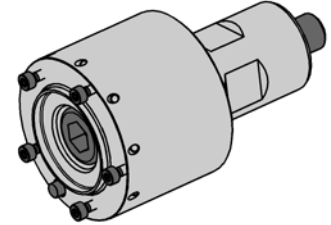
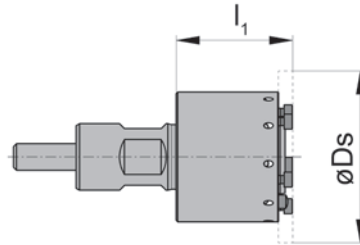
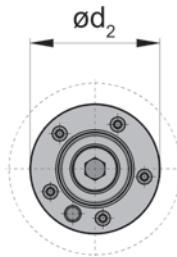
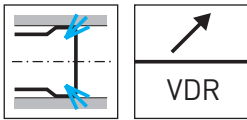

Innere Kühlmittelzufuhr
Through coolant supply



D = Durchgangsbohrung
Through hole

Bestellnummer Part number	$D_{s_{min}}$	$D_{s_{max}}$	l_1	d_2	Kühlung Coolant	Größe Size
MDR.044.32.30.V.D	35,601	43,6	30	32	D	044
MDR.052.39.35.V.D	43,601	51,6	35	39	D	052
MDR.061.46.40.V.D	51,601	60,6	40	46	D	061
MDR.081.56.50.V.D	60,601	80,6	50	56	D	081
MDR.101.76.60.V.D	80,601	100,6	60	76	D	101
MDR.121.76.60.V.D	100,601	120,6	60	76	D	121
MDR.141.76.60.V.D	120,601	140,6	60	76	D	141

1 Satz Schrauben, 1 Torx-Schlüssel im Lieferumfang enthalten
1 Set of screws, 1 Torx wrench - no separate order required!

Ersatzteile
Spare Parts

Reibschaft Reaming insert holder	Schraube Screw	Zylinderschraube Cylindrical screw
MDR.044.32.30.V.D	C009002	C002623
MDR.052.39.35.V.D	C009002	C002638
MDR.061.46.40.V.D	C009002	C002426
MDR.081.56.50.V.D	C009004	C002637
MDR.101-141...V.D	C009004	C002431



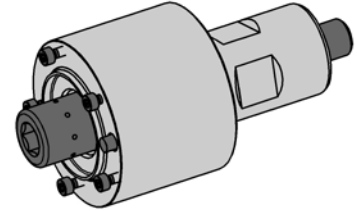
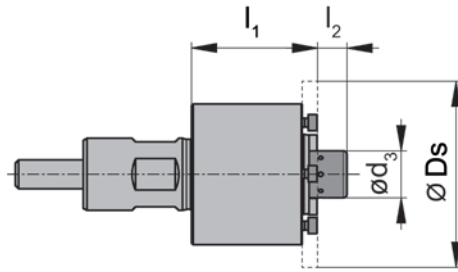
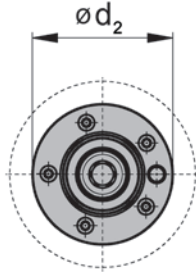
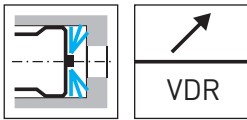

Innere Kühlmittelzufuhr
Through coolant supply



A = Absatzbohrung
Step hole

F

Bestellnummer Part number	$D_{s_{min}}$	$D_{s_{max}}$	l_2	l_1	d_2	d_3	Kühlung Coolant	Größe Size
MDR.044.32.30.V.A	35,601	43,6	8	30	32	13	A	044
MDR.052.39.35.V.A	43,601	51,6	8	35	39	13	A	052
MDR.061.46.40.V.A	51,601	60,6	10	40	46	16	A	061
MDR.081.56.50.V.A	60,601	80,6	12	50	56	18	A	081
MDR.101.76.60.V.A	80,601	100,6	14	60	76	24	A	101
MDR.121.76.60.V.A	100,601	120,6	14	60	76	24	A	121
MDR.141.76.60.V.A	120,601	140,6	14	60	76	24	A	141

1 Satz Schrauben, 1 Torx-Schlüssel im Lieferumfang enthalten
1 Set of screws, 1 Torx wrench - no separate order required!

Ersatzteile

Spare Parts

Reibschaft Reaming insert holder	Schraube Screw	Zylinderschraube Cylindrical screw
MDR.044.32.30.V.A	C009002	Z900200
MDR.052.39.35.V.A	C009002	Z900201
MDR.061.46.40.V.A	C009002	Z900202
MDR.081.56.50.V.A	C009004	Z900203
MDR.101-141...V.A	C009004	Z900204

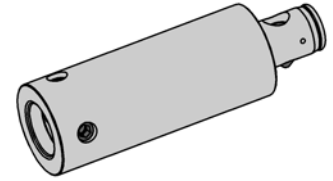
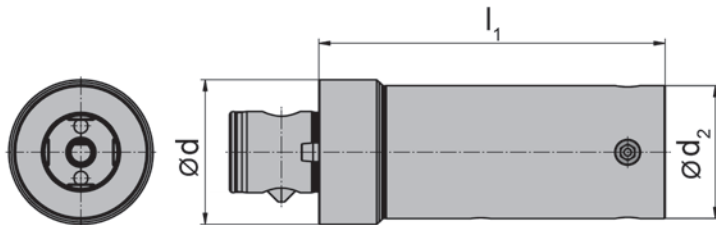

Bestellnummer Part number	$D_{s_{min}}$	$D_{s_{max}}$	l_1	d	d_2	Form	Größe Size
VDR.044.32.55.32.BM	35,601	43,6	55	32	32	BM	044
VDR.044.32.80.32.BM	35,601	43,6	80	32	32	BM	044
VDR.052.39.100.40.BM	43,601	51,6	100	40	39	BM	052
VDR.052.39.60.40.BM	43,601	51,6	60	40	39	BM	052
VDR.061.46.120.50.BM	51,601	60,6	120	50	46	BM	061
VDR.061.46.70.50.BM	51,601	60,6	70	50	46	BM	061
VDR.081.56.140.50.BM	60,601	80,6	140	50	56	BM	081
VDR.081.56.80.50.BM	60,601	80,6	80	50	56	BM	081
VDR.101.76.100.63.BM	80,601	200,2	100	63	76	BM	101-200
VDR.101.76.160.63.BM	80,601	200,2	160	63	76	BM	101-200

Ersatzteile
Spare Parts

Schaft Shank	Schraube Screw
VDR.044...	C009008
VDR.052...-061...	C009010
VDR.081...	C009012
VDR.101...	C009016

F

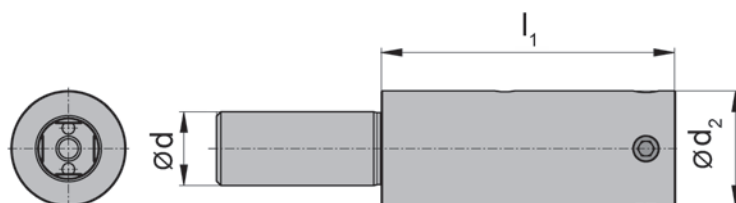
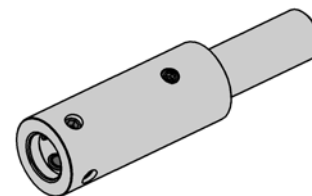
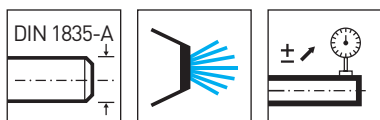

F

Bestellnummer Part number	$D_{s_{min}}$	$D_{s_{max}}$	l_1	d	d_2	Form	Größe Size
VDR.044.32.55.20.A	35,601	43,6	55	20	32	A	044
VDR.044.32.80.20.A	35,601	43,6	80	20	32	A	044
VDR.052.39.60.25.A	43,601	51,6	60	25	39	A	052
VDR.052.39.100.25.A	43,601	51,6	100	25	39	A	052
VDR.061.46.120.32.A	51,601	60,6	120	32	46	A	061
VDR.061.46.70.32.A	51,601	60,6	70	32	46	A	061
VDR.081.56.140.40.A	60,601	80,6	140	40	56	A	081
VDR.081.56.80.40.A	60,601	80,6	80	40	56	A	081
VDR.101.76.100.40.A	80,601	200,2	100	40	76	A	101-200
VDR.101.76.160.40.A	80,601	200,2	160	40	76	A	101-200

Ersatzteile

Spare Parts

Schaft Shank	Schraube Screw
VDR.044...	C009008
VDR.052...-061...	C009010
VDR.081...	C009012
VDR.101...	C009016

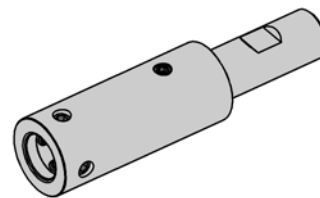
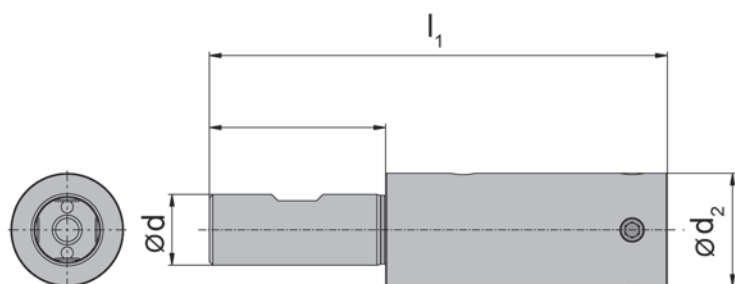
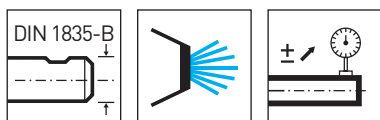

Bestellnummer Part number	Ds _{min}	Ds _{max}	l ₁	d	d ₂	Form	Größe Size
VDR.044.32.55.20.B	35,601	43,6	55	20	32	B	044
VDR.044.32.80.20.B	35,601	43,6	80	20	32	B	044
VDR.052.39.60.25.B	43,601	51,6	60	25	39	B	052
VDR.052.39.100.25.B	43,601	51,6	100	25	39	B	052
VDR.061.46.70.32.B	51,601	60,6	70	32	46	B	061
VDR.061.46.120.32.B	51,601	60,6	120	32	46	B	061
VDR.081.56.80.40.B	60,601	80,6	80	40	56	B	081
VDR.081.56.140.40.B	60,601	80,6	140	40	56	B	081
VDR.101.76.100.40.B	80,601	200,2	100	40	76	B	101-200
VDR.101.76.160.40.B	80,601	200,2	160	40	76	B	101-200

Ersatzteile

Spare Parts

Schaft Shank	Schraube Screw
VDR.044.32...	C009008
VDR.052...-061...	C009010
VDR.081.56...	C009012
VDR.101.76....	C009016

F

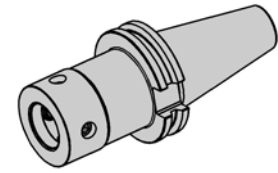
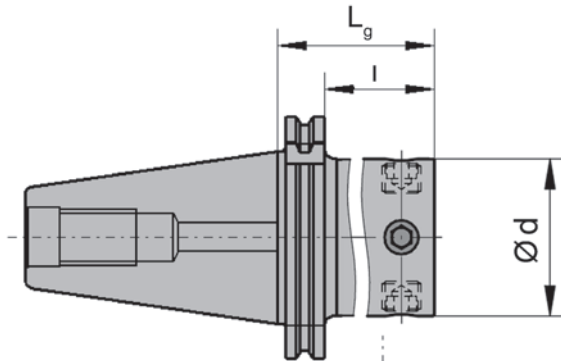
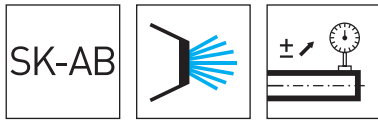

F

Bestellnummer Part number	Ds _{min}	Ds _{max}	l	Lg	d	Größe Size	System	Gewicht [kg] Weight [kg]
VDR.044.065.40AD	35,601	43,6	46	65	32	044	SK 40	1,1
VDR.052.065.40AD	43,601	51,6	46	65	39	052	SK 40	1,2
VDR.061.075.40AD	51,601	60,6	56	75	46	061	SK 40	1,4
VDR.081.080.40AD	60,601	80,6	61	80	56	081	SK 40	1,6
VDR.101.095.40AD	80,601	140,6	76	95	76	101-200	SK 40	2,2
VDR.044.065.50AD	35,601	43,6	46	65	32	044	SK 50	2,9
VDR.052.065.50 AD	43,601	51,6	46	65	39	052	SK 50	3
VDR.061.075.50AD	51,601	60,6	56	75	46	061	SK 50	3,2
VDR.081.085.50AD	60,601	80,6	66	85	56	081	SK 50	3,6
VDR.101.095.50AD	80,601	200,2	76	95	76	101-200	SK 50	4,6

Ersatzteile

Spare Parts

Schaft Shank	Schraube Screw
VDR.044...	C009008
VDR.052...-061...	C009010
VDR.081...	C009012
VDR.101...	C009016

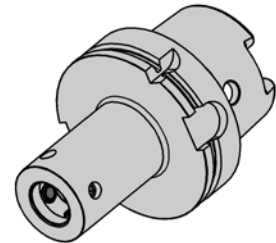
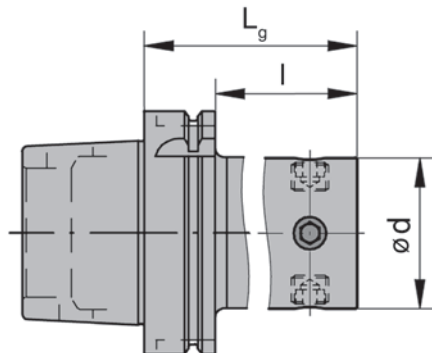
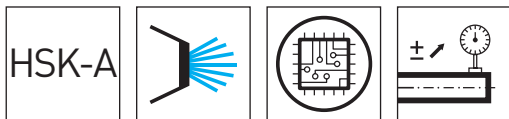

Bestellnummer Part number	$D_{s_{min}}$	$D_{s_{max}}$	l	Lg	d	Größe Size	System	Gewicht [kg] Weight [kg]
VDR.044.085.A063	35,601	43,6	59	85	32	044	HSK63	1
VDR.052.090.A063	43,601	51,6	64	90	39	052	HSK63	1,2
VDR.061.100.A063	51,601	60,6	74	100	46	061	HSK63	1,5
VDR.081.105.A063	60,601	80,6	79	105	56	081	HSK63	1,8
VDR.101.120.A063	80,601	140,6	94	120	76	101-200	HSK63	2,4
VDR.044.090.A100	35,601	43,6	61	90	32	044	HSK100	2,3
VDR.052.095.A100	43,601	51,6	66	95	39	052	HSK100	2,6
VDR.061.100.A100	51,601	60,6	71	100	46	061	HSK100	2,8
VDR.081.120.A100	60,601	80,6	91	120	56	081	HSK100	3,5
VDR.101.130.A100	80,601	200,2	101	130	76	101-200	HSK100	5

Das Kühlmittelrohr ist nicht im Lieferumfang enthalten - bitte separat bestellen!
Coolant tube is not included - separate order required!

Ersatzteile
Spare Parts

Schaft Shank	Schraube Screw
VDR.044...	C009008
VDR.052...-061...	C009010
VDR.081...	C009012
VDR.101...	C009016



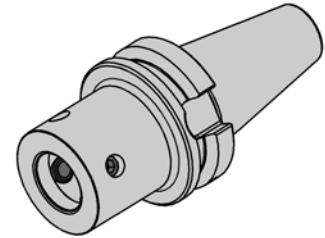
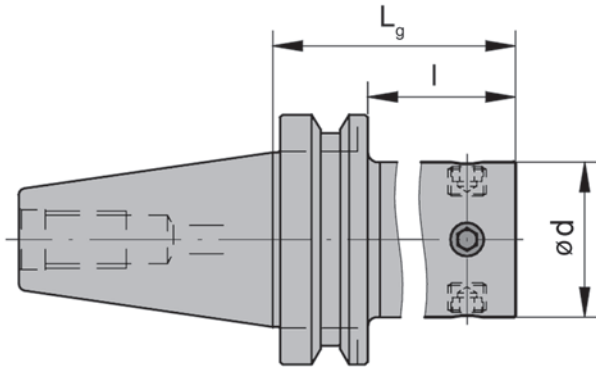
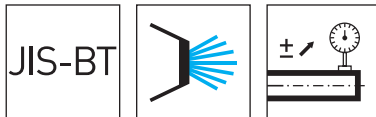

F

Bestellnummer Part number	$D_{s_{min}}$	$D_{s_{max}}$	l	Lg	d	Größe Size	System	Gewicht [kg] Weight [kg]
VDR.044.060.40BT	35,601	43,6	33	60	32	044	JIS-BT 40	1,1
VDR.052.065.40BT	43,601	51,6	38	65	39	052	JIS-BT 40	1,3
VDR.061.070.40BT	51,601	60,6	43	70	46	061	JIS-BT 40	1,4
VDR.081.080.40BT	60,601	80,6	53	80	56	081	JIS-BT 40	1,7
VDR.101.095.40BT	80,601	200,2	-	95	76	101-200	JIS-BT 40	2,5
VDR.044.065.50BT	35,601	43,6	27	65	32	044	JIS-BT 50	3,7
VDR.052.065.50BT	43,601	51,6	27	65	39	052	JIS-BT 50	3,8
VDR.061.075.50BT	51,601	60,6	37	75	46	061	JIS-BT 50	4
VDR.081.085.50BT	60,601	80,6	47	85	56	081	JIS-BT 50	4,3
VDR.101.095.50BT	80,601	200,2	57	95	76	101-200	JIS-BT 50	5,1

Ersatzteile

Spare Parts

Schaft Shank	Schraube Screw
VDR.044...	C009008
VDR.052...-061...	C009010
VDR.081...	C009012
VDR.101...	C009016



F

Am gezeigten Beispiel wird die Handhabung beim Ausrichten eines Reibwerkzeuges beschrieben.

The information below explains the proper handling and set up for reaming tools.



Die Einstellung sollte, um höchste Präzision zu erreichen direkt in der Maschine bzw. der Spindel erfolgen.

Tool adjustments should be performed directly in the machine/spindle to achieve highest precision.

F



Den jeweiligen Reibschaft entweder direkt oder in die entsprechende Reduzierhülse des Hydrodehnfutters bis zum Anschlag einführen.

Insert the reamer shaft into the Hydraulic Expansion Toolholder or reducer sleeve until it bottoms out.



Die Spannschraube des Hydrodehnfutters bis zum Anschlag mittels Innensechskantschlüssel eindrehen.

Tighten the clamping screw of the Hydraulic Expansion Toolholder with a hex wrench.



Die vier Einstellschrauben mit dem TORX PLUS®-Schlüssel T15PQ anlegen und den Rundlauf vorzugsweise am Aufnahmekegel mittels einer μm Uhr durch Drehen des Werkzeuges messen.

Turn the four adjusting screws with the TORX-PLUS® wrench T15PQ until contact, and check the runout with a μm indicator inside the arbor by hand rotating the tool.



Den Rundlauf mittels der vier Einstellschrauben jeweils in den Schraubenachsen justieren.

Adjust the runout by turning the adjustment screws on their axis.



Die Schneide aufsetzen (Positionierstift beachten) und die Spannschrauben leicht anlegen.

Lay insert on shaft with positioning hole over the pin and tighten the screws lightly.



Die Spannschrauben mit Torx Drehmomentschraubendreher über Kreuz anziehen.

Tighten the screws with a torque setter screw driver in a crisscross pattern.

Ausrichten

Um optimale Reibergebnisse zu erzielen, ist ein perfekter Rundlauf des Werkzeuges unumgänglich. Um Rundlauffehler von Aufnahme und Maschinenspindel auszugleichen, werden Ausricht-, Dehnspann- oder Schrumpffutter eingesetzt. DR-Reibwerkzeuge können mit verschiedenen Methoden gemessen werden:

Adjusting

To achieve the best reaming results a tool with zero runout is desirable. In order to compensate for any errors due to runout from the tool holders or the machine spindle, the following holders are recommendend: compensation holders, hydraulic chucks, or shrink fit holders. DR reamers can be measured with different methods:

Über Schneidenträger Kurzkegel

Bei demontierter Schneide direkt auf dem Kurzkegel des Schneidenträgers messen. Hohe Präzision, einfache Handhabung.

Through insert holder short taper

With the reamer disassembled measure directly on the insert holders short taper. High accuracy, simple handling. This is the most accurate and preferred method.

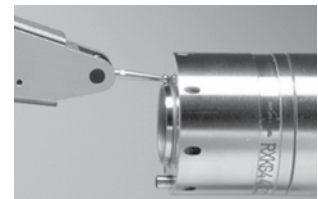

Über Rundschliffase

Messen unmittelbar hinter dem Anschnitt auf dem Außendurchmesser der Schneide. Es werden sämtliche Trennstellenfehler eliminiert. Genauste Messmethode.

Through circular land

Measuring directly behind chamfer angle on external insert diameter. All interface errors are eliminated. This is the preferred method for small diameter inserts.

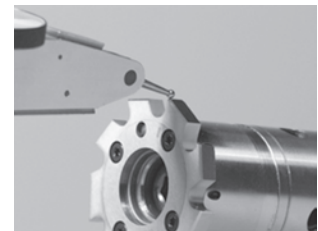

Über Schneidenträger-Außendurchmesser

DR-Werkzeuge werden in hoher Toleranz gefertigt. Diese Methode liefert akzeptable Präzision und ist einfach zu handhaben.

On the external diameter of the insert holder

DR tool holders are manufactured very accurately on all diameters. A method easy to handle that offers reasonable measuring results.

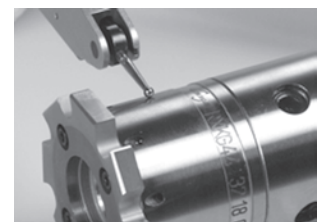

Schäfte mit integriertem Ausrichtmechanismus

Standard für Reib-Ø über 35 mm

Shanks with integrated compensation device

These shanks with integrated comp. must be used for reaming diameters bigger than 35 mm

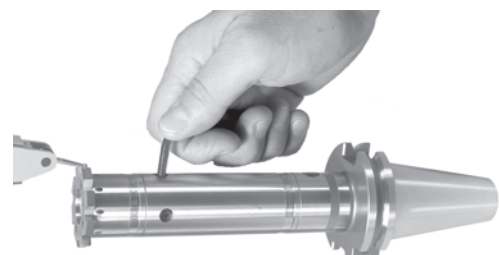

Handhabung

Zentrale Befestigungsschraube anziehen gemäß Tabellenwert 1. Rundlauf messen und Schneide auf höchsten Punkt drehen. Mit den Justierschrauben den halben Wert des Rundlaufes korrigieren. Kontrollieren und Justierung allenfalls wiederholen. Zentrale Befestigungsschraube anziehen gemäß Tabellenwert 2.



Systemgröße Md Parameter Md	1 Nm	2 Nm
DR 044	35	-
DR 052	35	-
DR 061	55	-
DR 081	60	85
DR 101	60	120
DR 121	60	120
DR 141	60	120

Handling

Secure central locking screw (see value no 1). Measure runout and set the cutting edge of the insert to the highest point. Compensate half of the total runout by using the adjustment screws. Check runout and repeat the adjustment if necessary. Secure central locking screw according to value 2 in chart below.

Schneidenwechsel

1. Schaft nicht aus der Grundaufnahme nehmen. Spannschrauben und verbrauchte Schneide entfernen.
2. Kurzkegel sorgfältig reinigen und auf mögliche Beschädigungen prüfen.
3. Neue Schneide aufsetzen (Positionierstift beachten) und Spannschrauben leicht anziehen
4. Vorzugsweise mit Torx-Drehmomentdreher Schrauben über Kreuz anziehen. (Drehmomente siehe Tabelle)

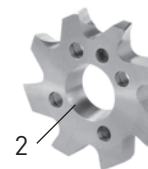

Systemgröße Md Parameter Md	Nm	Torx
DR 016	0,7	6
DR 019	0,7	6
DR 024	1,5	8
DR 029	1,5	8
DR 036	1,5	8
DR 044	1,5	8
DR 052	1,5	8
DR 061	1,5	8
DR 081	3,5	15
DR 101	3,5	15
DR121	3,5	15
DR141	3,5	15

Changing inserts

1. Don't take the shank out of the taper holder. Remove clamping screws and used insert.
2. Clean short taper of the shank carefully and check for possible damages.
3. Set new insert on position (pay attention to the positioning pin) and slightly tighten the clamping screws.
4. If available, use the torxtorque screw driver to tighten the screws crosswise (see torque chart)



Messen des Schneidendurchmessers

DR-Schneiden sind ungleich geteilt. Der Durchmesser kann nur über die beiden bezeichneten Schneiden, direkt beim Anschnitt, gemessen werden. Die Schneiden sind konisch geschliffen.

Measuring of insert diameter

DR inserts have an unequally spaced pitch. To measure the diameter line up the two marked cutting edges. Measure directly on the chamfered angle because the inserts are ground with taper.



Übersicht
Overview

Seite/Page
162-165

Schneidrad
Reaming head
DR large

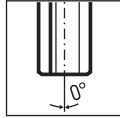

Seite/Page
166

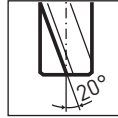

Seite/Page
167

Reibschaft
Reaming insert holder
MDR

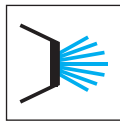

Seite/Page
168

Schaft
Shank
VDR

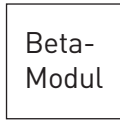

Seite/Page
169

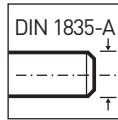

Seite/Page
170

Direktaufnahme
Direct mounting
VDR



Seite/Page
171



Seite/Page
172



Seite/Page
173

Technische Hinweise
Technical Instructions

Seite/Page
174-177

Kapitel
Technische Hinweise
Chapter
Technical Instructions

Seite/Page
179-193

DR large



F

Modulares Reibsystem

Ø 139,8 - 200,2 mm

Modular Reaming System

Ø 139,8 - 200,2 mm

Systemgröße DR150 - DR200

System Size DR150 - DR200



Modulares System für Ø 139,8 - 200,2 mm

Modular System for Ø 139.8 - 200.2 mm

Systemaufnahme Beta-Modul

System adaptor Beta-Module

Kapitel Systemaufnahmen URMA

Chapter System adapter URMA

Ausgleichshalter

Balancing shank

VDR

zylindrisch
cylindrical

VDR

direkt
direct

BD

BH

BT

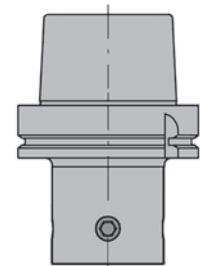
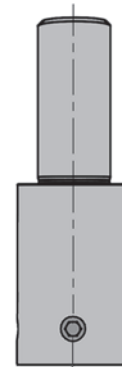
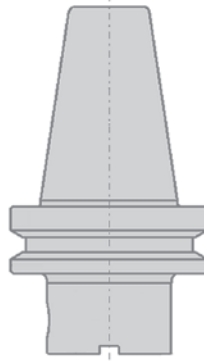
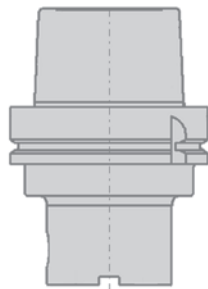
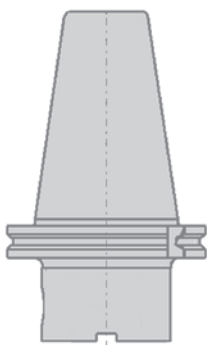

B13

Verlängerung
Extension
Beta-Modul

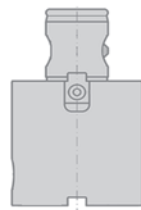

VDR

Ausgleichshalter
Balancing shank
Beta-Modul



MDR

Reibschaff
Reaming insert holder

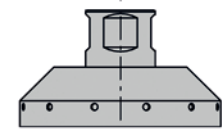

DR

Schneidrad
Reaming head



Spannschrauben für Platte
Screws for insert

Schraube für Halter
Screw for holder

F

Bei Anfragen mit Angaben der Bohrungstoleranz wird der Schneidringdurchmesser durch den HORN-Standard definiert. Der Schneidringdurchmesser liegt je nach Größe der Toleranz bei 65% bis 80% des Bohrungstoleranzfeldes.

Der durch den HORN-Standard festgelegte Durchmesser wird immer als Festmaß ausgewiesen.

Beispiel 1:

Anfrage mit ISO Bohrungstoleranz:
Durchmesser: 160H7 Festmaß

Durchmesser nach HORN-Standard:
Durchmesser: 160,033 mm

Schneidringbezeichnung:
DR.160033.A01.L.S HL3M

Beispiel 2:

Anfrage mit Bohrungstoleranz:
Durchmesser: 185 +0,030 -0,015 mm

Festmaßdurchmesser nach HORN-Standard:
Durchmesser: 185,021 mm

Schneidringbezeichnung:
DR.185021.C01.G.S AN4M

Beispiel 3:

Anfrage mit definiertem Schneidringmaß
Durchmesser: 193,158 mm

Festmaß Durchmesser nach HORN-Standard:
Durchmesser: 193,158 mm

Schneidringbezeichnung:
DR.193158.B06.L.S HL3M

Das Fertigungsmaß des Schneidrings beträgt immer +/-0,003 mm

For requests with specifications of the bore tolerance, the reaming head diameter is defined by the HORN standard. Depending on the diameter and the tolerance range, the reaming head diameter will be within 65% to 80% of the total bore tolerance range.

The diameter specified by the HORN standard is always shown as a target size dimension.

Example 1:

Request with ISO bore tolerance
Diameter: 160H7

Target size diameter according to HORN standard: Diameter: 160,033 mm

Reaming head part number:
DR.160033.A01.L.S HL3M

Example 2:

Request with bore tolerance
Diameter: 185 +0,030 -0,015 mm

Target size diameter according HORN standard: Diameter: 185,021 mm

Reaming head part number:
DR.185021.C01.G.S AN4M

Example 3:

Request with reaming head target size
Diameter: 193,158 mm

Target size diameter according HORN-standard: Diameter: 193,158 mm

Reaming head part number:
DR.193158.B06.L.S HL3M

The reaming head manufacturing tolerance is always +/-0,003 mm

Bestellbeispiel mit Festmaß

Ordering example with fixed dimension

DR.150033.G16.L.2 HL3M (N)

DR

DR Systembezeichnung

DR System designation

150,033

Durchmesser in mm

Diameter in mm

G16

Schneidengeometrie (weitere Geometrien siehe „Standard Schneidräder“)

Cutting geometry (for more geometries see „Standard Reaming Heads“)

L

Verzahnungsrichtung (G = gerade, L = linksschräg)

Helix angle (G = straight, L = left-hand helix)

2

Schneidkantenverrundung (weitere Ausführungen siehe unten)

Cutting edge preparation (for more versions see below)

HL3

Beschichtung (weitere Beschichtungen siehe „Standard Schneidräder“)

Coating (for more coatings see „Standard Reaming Heads“)

M

Hartmetallsubstrat

Carbide substrate

(N)

Freilassung für Aufbereitung (N)

Left out for reprocessing

Weitere Schneidkantenverrundungen

More cutting edge preparations

S

ohne Schneidkantenverrundung

without cutting edge preparation

2

mittlere Schneidkantenverrundung

medium cutting edge preparation

3

stärkere Schneidkantenverrundung

larger cutting edge preparation

Standard Schneidräder DR large

Standard Reaming heads



Der Schneidendurchmesser kann durch die Vervollständigung der Bestellnummer frei bestimmt werden.

Schnittparameter erhalten Sie auf Anfrage.

The cutting edge diameter can be freely determined by completing the part number.

Cutting data available upon request

Gerade verzahnte Schneidräder -
für Sacklochbohrungen und teilweise für Durchgangsbohrungen

straight fluted reaming heads -
for blind holes and partly for through holes

Bestellnummer Part number	Anschnittwinkel Firstcut angle	Verrundung Preparation	Verjüngung Backtaper	P	M	K	N
DR. _____ A06.G.S HL3M	45°	-	x2	•	•	○	
DR. _____ G16.G.S HL3M	60°/43°	-	x2	•	•	○	
DR. _____ C16.G.S HL3M	45°/20°	-	x2	•	•	○	
DR. _____ A06.G.2 HL3M	45°	2	x2	○		•	
DR. _____ G16.G.2 HL3M	60°/43°	2	x2	○		•	
DR. _____ C16.G.2 HL3M	45°/20°	2	x2	○		•	
DR. _____ A01.G.3 AN4M	45°	3	x1	○		•	
DR. _____ C11.G.3 AN4M	45°/20°	3	x1	○		•	
DR. _____ C16.G.S NP1M	45°/20°	-	x2				•

Im kurzspanenden Werkstoff auch für Durchgangsbohrungen geeignet.

In short chipping material also suitable for through holes.

Linksschräg verzahnte Schneidräder -
für Durchgangsbohrungen

left hand fluted reaming heads -
for through holes

Bestellnummer Part number	Anschnittwinkel Firstcut angle	Verrundung Preparation	Verjüngung Backtaper	P	M	K	N
DR. _____ C16.L.S HL3M	45°/20°	-	x2	•	•	○	
DR. _____ B06.L.S HL3M	25°	-	x2	•	•	○	
DR. _____ C16.L.2 HL3M	45°/20°	2	x2	○		•	
DR. _____ B06.L.2 HL3M	25°	2	x2	○		•	
DR. _____ A06.L.S HL3M	45°	-	x2	•	•	○	
DR. _____ C16.L.S NP1M	45°/20°	-	x2				•



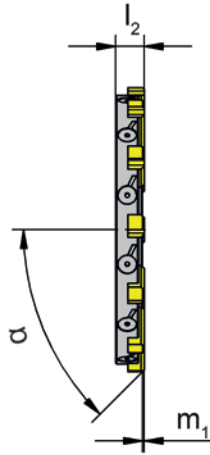
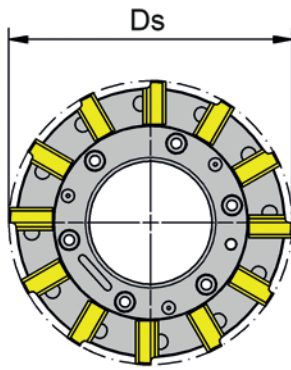
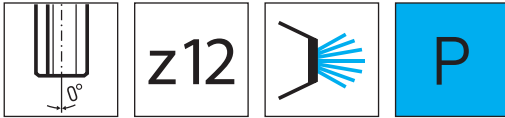

HM-Sorten
Carbide grades

▲ ab Lager
on stock

Δ 4 Wochen
4 weeks

F

Bestellnummer Part number	Ds	Ds _{min}	Ds _{max}	Größe Size	m ₁	α	l ₂	Z	HL3M
DR.140033.A06.G.S	140,033	139,801	149,8	150	0,85	45°	15	12	Δ
DR.150033.A06.G.S	150,033	149,801	159,8	160	0,85	45°	15	12	Δ
DR.160033.A06.G.S	160,033	159,801	169,8	170	0,85	45°	15	12	Δ
DR.170033.A06.G.S	170,033	169,801	179,8	180	0,85	45°	15	12	Δ
DR.180033.A06.G.S	180,033	179,801	189,8	190	0,85	45°	15	12	Δ
DR.190037.A06.G.S	190,037	189,801	200,2	200	0,85	45°	15	12	Δ
DR.200037.A06.G.S	200,037	189,801	200,2	200	0,85	45°	15	12	Δ
									P ●
									M ●
									K ○
									N -
									S ○
									H ○

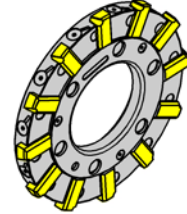
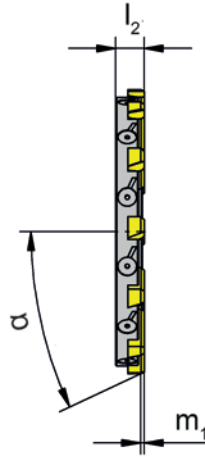
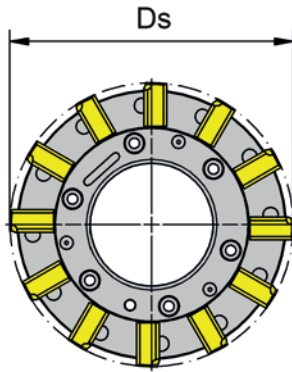
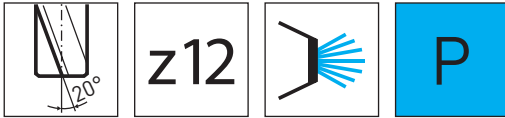

HM-Sorten
Carbide grades

▲ ab Lager
on stock

Δ 4 Wochen
4 weeks

Bestellnummer Part number	Ds	Ds _{min}	Ds _{max}	Größe Size	m ₁	α	l ₂	Z	HL3M
DR.140033.B06.L.S	140,033	139,801	149,8	150	1,82	25°	15	12	Δ
DR.140033.B06.L.S	140,033	139,801	149,8	150	1,82	25°	15	12	Δ
DR.150033.B06.L.S	150,033	149,801	159,8	160	1,82	25°	15	12	Δ
DR.160033.B06.L.S	160,033	159,801	169,8	170	1,82	25°	15	12	Δ
DR.170033.B06.L.S	170,033	169,801	179,8	180	1,82	25°	15	12	Δ
DR.180033.B06.L.S	180,033	179,801	189,8	190	1,82	25°	15	12	Δ
DR.190037.B06.L.S	190,037	189,801	200,2	200	1,82	25°	15	12	Δ
DR.200037.B06.L.S	200,037	189,801	200,2	200	1,82	25°	15	12	Δ
									P ●
									M ●
									K ○
									N -
									S -
									H -



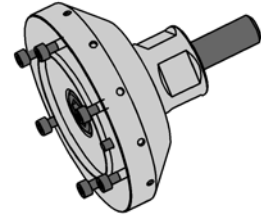
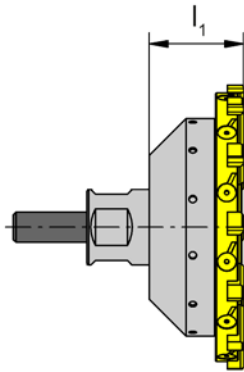
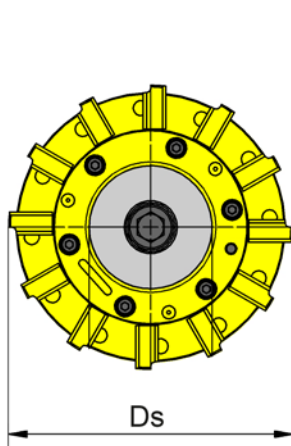
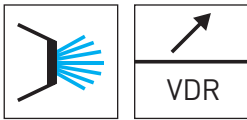

F

Bestellnummer Part number	$D_{s_{min}}$	$D_{s_{max}}$	l_1	D_s	Kühlung Coolant	Größe Size	Gewicht [kg] Weight [kg]
MDR.150.115.50.V.D	139,8	159,8	50	115	D	150-160	2,7
MDR.170.135.50.V.D	159,801	179,8	50	135	D	170-180	3,5
MDR.190.155.50.V.D	179,801	200,2	50	155	D	190-200	4,6

Ersatzteile
Spare Parts

Schaft Shank	Schraube Screw
MDR.1...	C0 22 07

Beta-
Modul

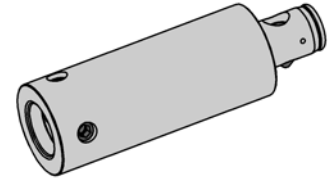
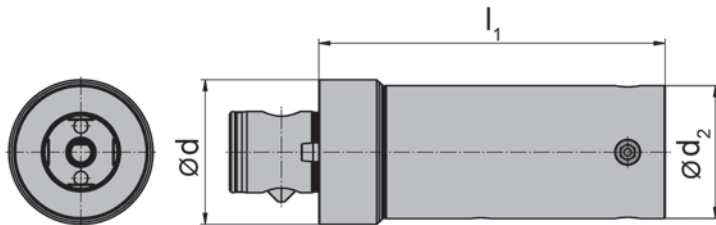
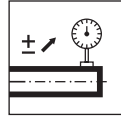

Bestellnummer Part number	$D_{s_{min}}$	$D_{s_{max}}$	l_1	d	d_2	Form	Größe Size
VDR.101.76.100.63.BM	80,601	200,2	100	63	76	BM	101-200
VDR.101.76.160.63.BM	80,601	200,2	160	63	76	BM	101-200

F

Ersatzteile
Spare Parts

Schaft Shank	Schraube Screw
VDR.101...	C009016

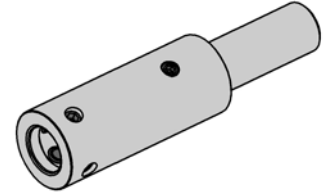
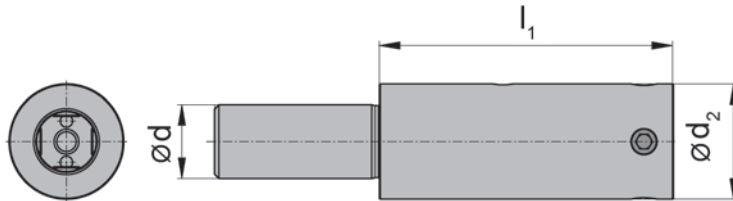
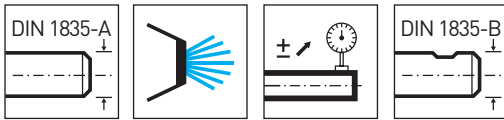

F

Bestellnummer Part number	$D_{s_{min}}$	$D_{s_{max}}$	l_1	d	d_2	Form	Größe Size
VDR.101.76.100.40.A	80,601	200,2	100	40	76	A	101-200
VDR.101.76.160.40.A	80,601	200,2	160	40	76	A	101-200
VDR.101.76.100.40.B	80,601	200,2	100	40	76	B	101-200
VDR.101.76.160.40.B	80,601	200,2	160	40	76	B	101-200

Ersatzteile

Spare Parts

Schaft Shank	Schraube Screw
VDR.101...	C009016

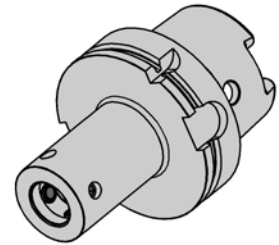
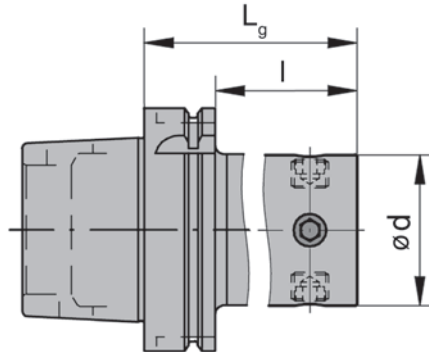
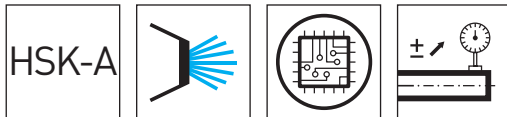

Bestellnummer Part number	$D_{s_{min}}$	$D_{s_{max}}$	l	Lg	d	Größe Size	System	Gewicht [kg] Weight [kg]
VDR.101.120.A063	80,601	200,2	94	120	76	101-200	HSK63	2,4
VDR.101.130.A100	80,601	200,2	101	130	76	101-200	HSK100	5

Ersatzteile
Spare Parts

Schaft Shank	Schraube Screw
VDR.101...	C009016



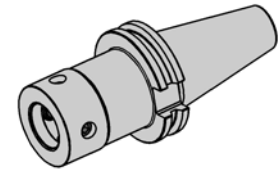
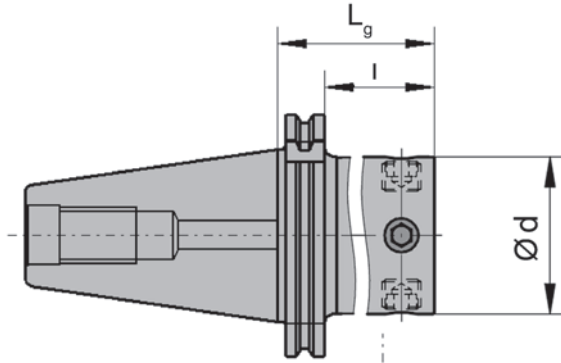
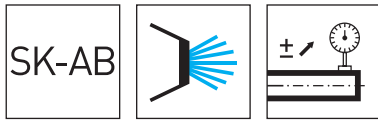

F

Bestellnummer Part number	Ds _{min}	Ds _{max}	l	Lg	d	Größe Size	System	Gewicht [kg] Weight [kg]
VDR.101.095.40AD	80,601	200,2	76	95	76	101-200	SK 40	2,2
VDR.101.095.50AD	80,601	200,2	76	95	76	101-200	SK 50	4,6

Ersatzteile
Spare Parts

Schaft Shank	Schraube Screw
VDR.101...	C009016

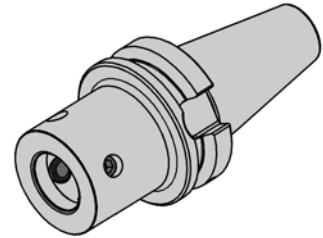
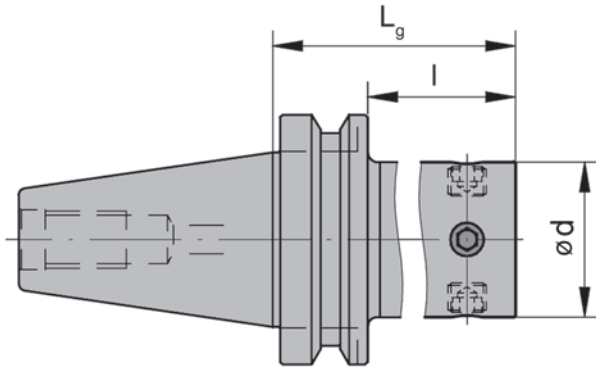
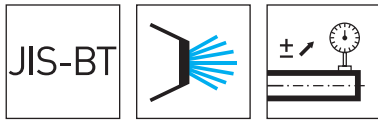

Bestellnummer Part number	$D_{s_{min}}$	$D_{s_{max}}$	l	Lg	d	Größe Size	System	Gewicht [kg] Weight [kg]
VDR.101.095.40BT	80,601	200,2	-	95	76	101-200	JIS-BT 40	2,5
VDR.101.095.50BT	80,601	200,2	57	95	76	101-200	JIS-BT 50	5,1

Ersatzteile
Spare Parts

Schaft Shank	Schraube Screw
VDR.101...	C009016

F

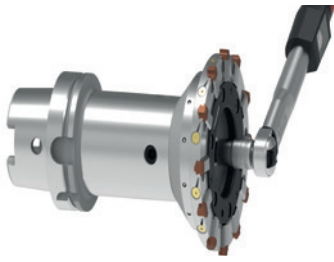

1. Werkzeugzusammenbau
Assemble the tool



2. Rundlauf einstellen
Adjust run-out



3. Werkzeug im Einsatz
Tool in use

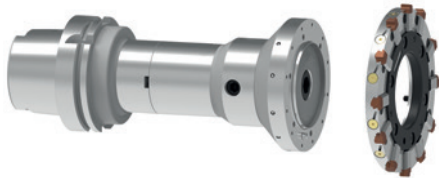

4. Nach Standzeitende gebrauchte Schneide demontieren
After tool life end disassemble used reaming head.



5. Montage neues Schneidrad
Assembly new reaming head



6. Werkzeug im Einsatz
Tool in use

1.

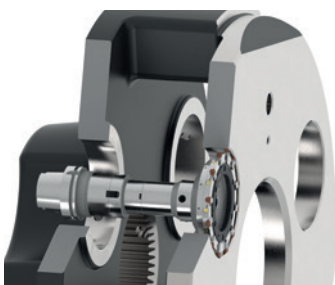

1. Werkzeug im Einsatz. Nach Standzeitende kann der Schneidring zur Aufbereitung an HORN zurückgeschickt werden.

Tool in use. After tool life ends, the reaming head can be returned to HORN for reconditioning.

2. a) Schneidring kann auf gleichen Durchmesser und Geometrie aufbereitet werden.

b) Schneidring kann auf andere Durchmesser und/oder Geometrie aufbereitet werden.

2. a) Reaming head can be reconditioned to same size and geometry.

b) Reaming head can be reconditioned to other size and/or geometry.

2.

a)



b)

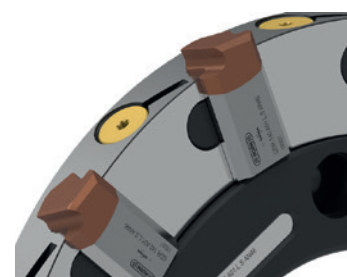

F

3.

a)

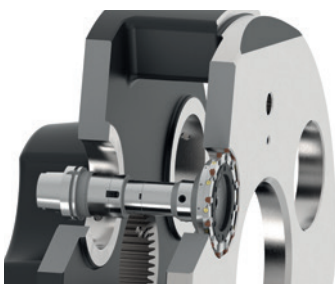

b)

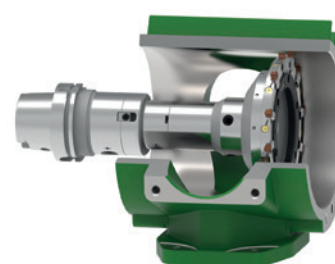

3. a) Werkzeug in der gleichen Bohrung einsetzen.

b) Werkzeug in einer anderen Bohrung einsetzen.

3. a) Use tool in the same bore.

b) Use tool in a different bore.



Anforderungen

- Präzision
- Prozesssicherheit
- Einfaches Handling
- Produktivität

Requirements

- Precision
- Process reliability
- Simple handling
- Productivity

Anwendungsbeispiel „Planetenträger“

Material: EN-GJS 400

Example of a „Planet Carrier“ Application

Material: EN-GJS 400

Schnittdaten

Cutting Data

v_c	125 m/min
f_z	0,20 mm
z	12
v_f	530 mm/min
a_p	0,15 mm
\emptyset	180 N6 mm
L	2x120 mm
XS	650 mm



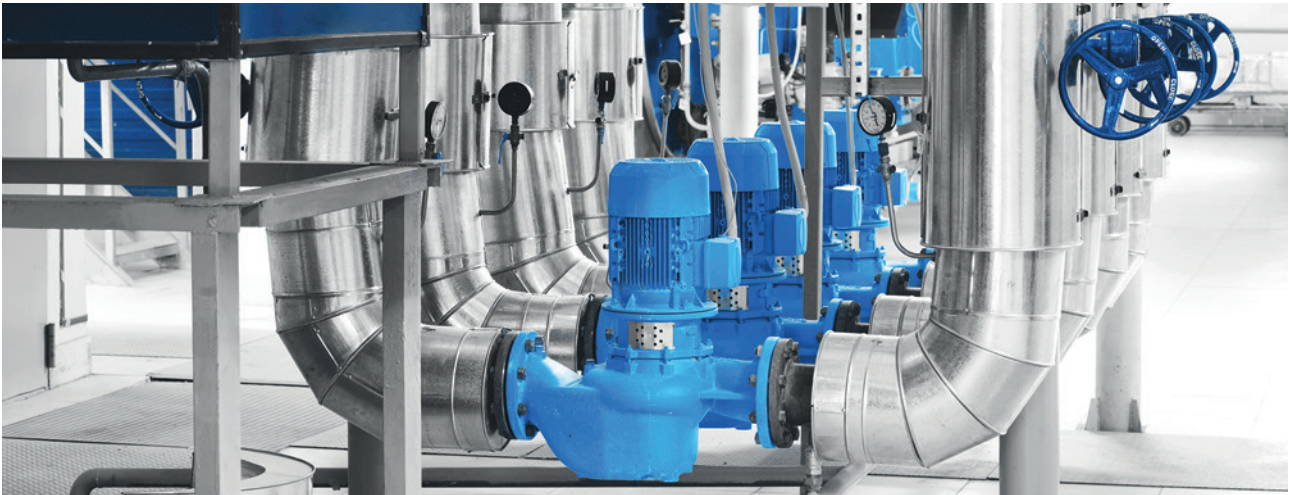

Anforderungen

- Präzision
- Prozesssicherheit
- Tiefe Kosten
- Einfaches Handling

Requirements

- Precision
- Process reliability
- Low costs
- Simple handling

Anwendungsbeispiel „Pumpengehäuse“

Material: GG25

Example of a „Pump Housing“ Application

Material: GG25



Schnittdaten

Cutting Data

v_c	100 m/min
f_z	0,15 mm
z	12
v_f	353 mm/min
a_p	0,15 mm
\emptyset	162 H8 mm
L	300 mm
Ra	1,2 μ m
XS	350 mm

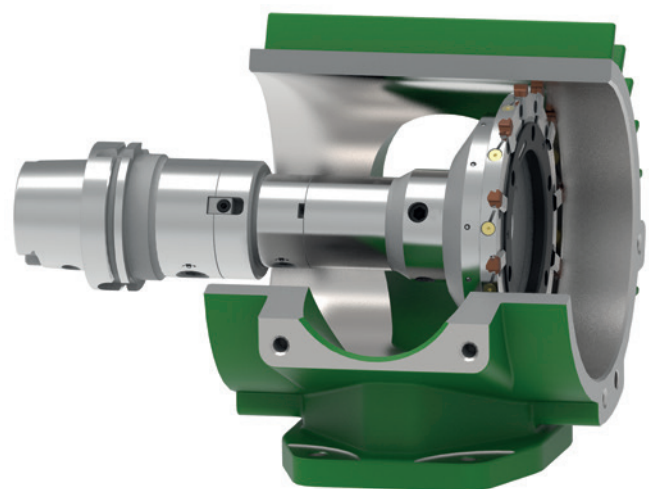

F



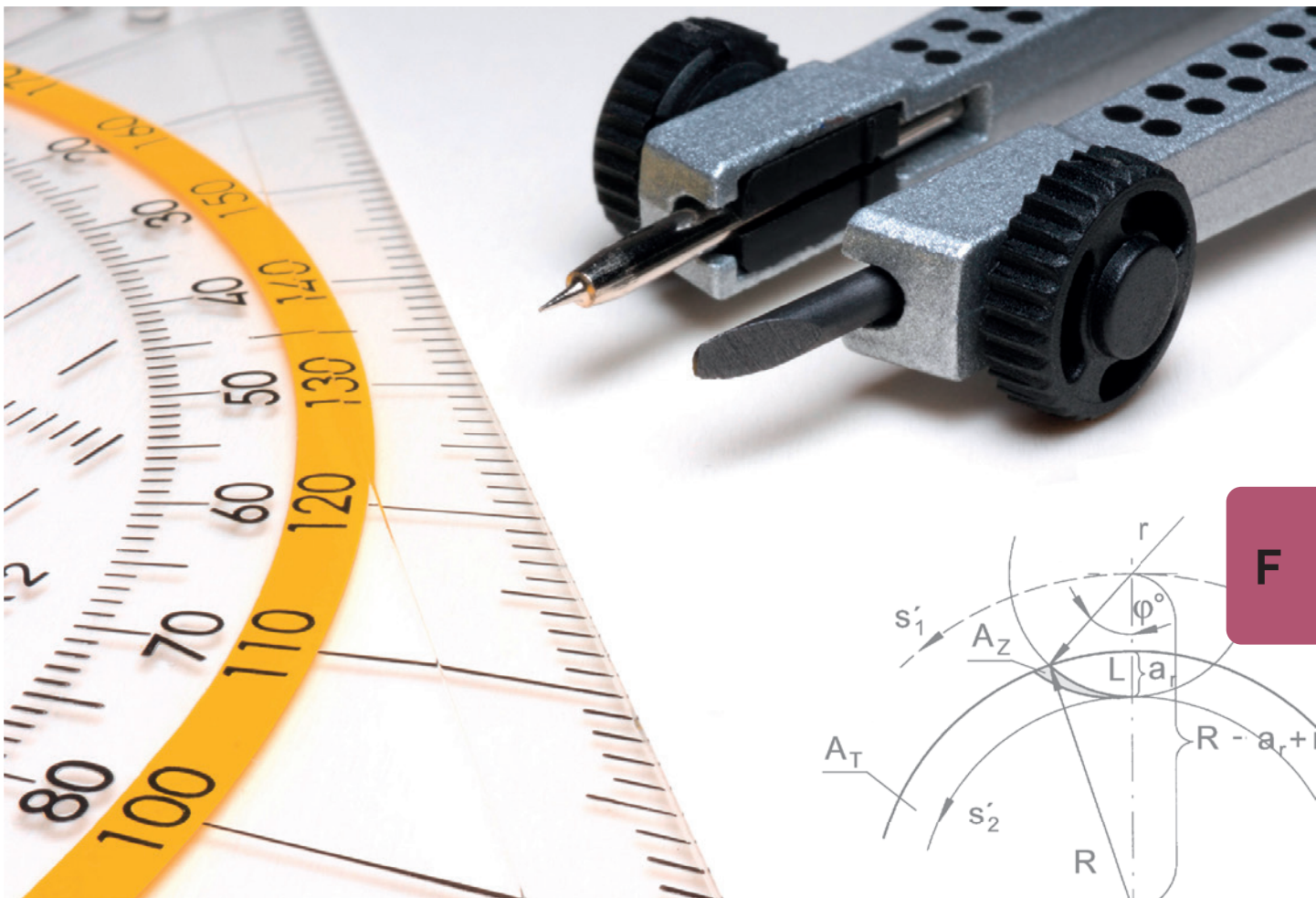

Inhalt/Summary	Seite/Page
Beschichtungsübersicht Coating Overview	180
Geometrien Geometries	181
Schnittdaten Cutting Data	182 - 187
Technische Hinweise Technical Instructions	188 - 193

Beschichtungsübersicht DR small, DR medium



Coating Overview DR small, DR medium

Schneidstoff Material group	Schichtaufbau Coating structure	Empfehlung Recommendation						Anwendung Application
		P05	M05	K05	N05	S05	H05	
HL3H	AlCrN	P10	M10	K10	N10	S10	H10	Für mittlere bis hohe Schnittgeschwindigkeiten, auch geeignet für unterbrochenen Schnitt For medium to high cutting speeds, also suitable for interrupted cut
		P20	M20	K20	N20	S20	H20	
		P30	M30	K30	N30	S30	H30	
		P40	M40	K40	N40			
		P50	M50					
AN2H AN4H	AlCrSiN	P10	M10	K10	N10	S10	H10	Für hohe Schnittgeschwindigkeiten, auch geeignet für leichte Schnittunterbrechungen For high cutting speed, also suitable for low cutting interruptions
		P20	M20	K20	N20	S20	H20	
		P30	M30	K30	N30	S30	H30	
		P40	M40	K40	N40			
		P50	M50					
DT2H	DLC	P10	M10	K10	N10	S10	H10	Erste Wahl für Al-Knetlegierungen. Für mittlere bis hohe Schnittgeschwindigkeiten, auch geeignet für unterbrochenen Schnitt First choice for Al-wrought alloys. For medium to high cutting speeds, also suitable for interrupted cut
		P20	M20	K20	N20	S20	H20	
		P30	M30	K30	N30	S30	H30	
		P40	M40	K40	N40			
		P50	M50					
NP1H	ta-C	P10	M10	K10	N10	S10	H10	Erste Wahl für Al (Si < 5%), auch geeignet für unterbrochenen Schnitt First choice for Al (Si < 5%) also suitable for interrupted cut
		P20	M20	K20	N20	S20	H20	
		P30	M30	K30	N30	S30	H30	
		P40	M40	K40	N40			
		P50	M50					
H20	Cermet, unbeschichtet uncoated	P10	M10	K10	N10	S10	H10	Nur für System DR016 - DR101, für mittlere bis hohe Schnittgeschwindigkeiten in Stahl (Ni < 2%), mit max. Zugfestigkeit von 1200 N/mm². Guss nur GGG40 empfehlenswert. Nicht für unterbrochenen Schnitt geeignet. System DR016 - DR101 only, for medium to high cutting speed in steel (Ni < 2%), with max. tensile strength of 1200 N/mm². Cast iron only GGG40 recommended. Not suitable for interrupted cut
		P20	M20	K20	N20	S20	H20	
		P30	M30	K30	N30	S30	H30	
		P40	M40	K40	N40			
		P50	M50					
AD3H AD4H	TiAlN+AlCrN	P10	M10	K10	N10	S10	H10	Für gehärtete Stähle bis max. 63 HRC, bei tiefen Schnittgeschwindigkeiten, Vorschüben und Aufmaßen. For hardened steels up to max. 63 HRC, at low cutting speeds, feed rates and stock removal
		P20	M20	K20	N20	S20	H20	
		P30	M30	K30	N30	S30	H30	
		P40	M40	K40	N40			
		P50	M50					

ISO 513		P	M	K	N	S	H
+ Zähigkeit / Tenacity - Verschleißfestigkeit / Wear resistance	05	05	05	05	05	05	05
	10	10	10	10	10	10	10
	20	20	20	20	20	20	20
	30	30	30	30	30	30	30
	40	40	40	40	40		
	50	50					

Gerade verzahnte Reibschneiden -
für Sacklochbohrungen und teilweise für Durchgangsbohrungen

straight fluted reaming inserts -
for blind holes and partly for through holes

Geometrie Geometry	Anschnittwinkel Firstcut angle	Verjüngung Backtaper	Spanwinkel Rake angle	P	M	K	N	H
A1	45°	x1	x1	●	○	●	○	○
A6	45°	x2	x1	●	○	●	○	●
A7	45°	x2	x1,5	●	●	○	●	-

Linksschräg verzahnte Reibschneiden -
für Durchgangsbohrungen

left hand fluted reaming inserts -
for through holes

Geometrie Geometry	Anschnittwinkel Firstcut angle	Verjüngung Backtaper	Spanwinkel Rake angle	P	M	K	N	H
B1	25°	x1	x1	●	○	●	○	-
B6	25°	x2	x1	●	○	●	○	-
B7	25°	x2	x1,5	●	●	○	●	-



Schnittdaten DR small, medium

Cutting Data DR small, medium



Werkstoff Material		Materialgruppe Material group	Härte (HB) Hardness Brinell	Zugfestigkeit R_m [N/mm ²] Tensile Strength	Beispiel Werkstoff Example Material	
P	unlegierter Stahl Carbon steel	~ 0,2 % C	P1.1	125	430	CK15
		~ 0,4% C geglüht annealed	P1.2	190	610	19Mn6
		~ 0,4% C vergütet quenched	P1.3	210	640	36Mn5
		~ 0,6% C geglüht annealed	P1.4	190	610	C55
		~ 0,6% C vergütet quenched	P1.5	300	1000	CK60
		Automatenstahl Free cutting steel	P1.6	220	750	9SMn28
	niedrig legierter Stahl (<5%) Alloyed steel	geglüht annealed	P2.1	180	590	100Cr6
		vergütet quenched	P2.2	280	960	14NiCr10
		vergütet quenched	P2.3	350	1250	34CrMo4
		vergütet quenched	P2.4	430	1450	55Cr3
	hochlegierter Stahl (>5%) high alloyed steel	geglüht annealed	P3.1	200	680	X10CrAl18
		gehärtet hardened	P3.2	350	1200	X210Cr2
	Stahlguss Cast steel	unlegiert unalloyed	P4.1	180	590	GE200
		legiert alloyed	P4.2	220	750	GX40CrSi28
	Sinterstahl Sintered steel	weich soft	P5.1	220	570	Sint-D39
M	Rostfreier Stahl Stainless steel	martensitisch ferritisch martensitic ferritic	M1.1	200	680	X16Cr13
		austenitisch austenitic	M1.2	300	1000	X6CrNiMo- Ti17-12-2
		austenitisch ferritisch austenitic ferritic	M1.3	230	780	X2CrNiMo- N17-13-3

F

Schnittdaten DR small, medium

Cutting Data DR small, medium



	Schnittgeschwindigkeit vc (m/min) / Startwerte mit IK Cutting speed vc (m/min) / Start values with IC						
	MG10	HL3H	AN2H AN4H	AD3H AD4H	DT2H	NP1H	H20
	35-25	220-140	220-140				240-150
	30-20	190-130	190-130				220-140
	30-18	180-120	180-120				200-130
	25-15	160-100	160-100				170-110
	18-12	190-50	190-50				160-100
	30-20	180-120	180-120				190-130
	30-20	180-120	180-120				190-130
	15-9	160-100	160-100				170-110
	10-6	120-80	120-80				
	9-5	100-60	100-60				
	8-4	120-80	120-80				
	5-3	90-50	90-50				
	25-15	160-100	160-100				170-110
	18-12	140-80	140-80				190-50
		190-50	190-50				
	8-4	90-50	90-50				
		50-30					
		25-15	25-15				



Schnittdaten DR small, medium

Cutting Data DR small, medium



F

Werkstoff Material		Materialgruppe Material group	Härte (HB) Hardness Brinell	Zugfestigkeit R_m [N/mm ²] Tensile Strength	Beispiel Werkstoff Example Material	
K	Grauguss Grey cast iron	niedrige Festigkeit low tensile strength	K1.1	180	250	GG-25
		hohe Festigkeit high tensile strength	K1.2	250	350	GG-40
	Kugelgraphitguss Spheroidal graphite cast iron	ferritisch ferritic	K2.1	160	400	GGG-40
		perlitisch perlitic	K2.1	260	700	GGG-60
	Temperguss Malleable cast iron	ferritisch ferritic	K3.1	200	400	GTW-45
		perlitisch perlitic	K3.2	260	700	GTS-55-04
	Ausferritisches Gusseisen / ADI Ausferritic spheroidal cast iron / ADI	vergütet quenched	K4.1	260	800	
		vergütet quenched	K4.2	350	1050	
		vergütet quenched	K4.3	450	1400	
N	Al-Legierungen Al-alloys	nicht vergütbar not heat treatable	N1.1	30		AlMg1
		vergütbar heat treatable	N1.2	100	340	AlMgSi1
	Al-Guss- Legierung Al-cast-alloy	< 6% Si	N2.1	80	300	AlMgSi6
		6-10% Si	N2.2	100	320	AlSi7Mg
		10-15 % Si	N2.3	130	450	AlSi12
	Kupfer- Legierungen Copper-alloys	Reinkupfer Pure copper	N3.1	100	340	Cu
		Messing, Bronze Brass	N3.2	90	310	CuZn40Pb
		Messing bleifrei Lead-free brass	N3.3	110	430	CuZn40
		hochfest high strength	N3.4	300	1000	CuZn25Al5- Mn4Fe3
	Graphit Graphite		N4.1			

Schnittdaten DR small, medium

Cutting Data DR small, medium



Schnittgeschwindigkeit vc (m/min) / Startwerte mit IK Cutting speed vc (m/min) / Start values with IC								
	MG10	HL3H	AN2H AN4H	AD3H AD4H	DT2H	NP1H	H20	
	30-20	170-110	170-110					
	30-20	170-110	170-110					
	25-15	170-110	170-110				170-110	
	22-14	140-80	140-80					
	25-15	170-110	170-110					
	22-14	140-80	140-80					
		90-50	90-50					
		60-40	60-40					
	60-40				300-200			
	50-30				270-170			
	40-25				220-140	300-200		
	25-15				170-110	250-150		
						220-140		
					70-50			
	100-60	220-140	220-140		160-100	190-130		
	100-60	170-110	170-110		160-100	190-130		
						80-60		
						90-50		



Schnittdaten DR small, medium

Cutting Data DR small, medium



F

Werkstoff Material		Materialgruppe Material group	Härte (HB) Hardness Brinell	Zugfestigkeit R _m [N/mm ²] Tensile Strength	Beispiel Werkstoff Example Material	
S	Warmfeste Legierung (Fe) Heat resistant alloy	geglüht annealed	S1.1	200	670	
		gehärtet hardened	S1.2	275	930	
	Warmfeste Legierung (Ni, Co) Heat resistant alloy	geglüht annealed	S2.1	250	840	Inconel 600
		gehärtet hardened	S2.2	350	1200	Inconel 713
	Titan	Titanlegierung α Titanium alloy α	S3.1	120	240	
		Titanlegierung α-β Titanium alloy α-β	S3.2	360	1200	
Titanlegierung β Titanium alloy β		S3.3	410	1400		
H	Gehärtete Stähle Hardened steels	50-55 HRC	H1.1	-	-	
		55-60 HRC	H1.2	-	-	
		60-63 HRC	H1.3	-	-	
		> 63HRC	H1.4	-	-	
O	Thermoplaste Thermoplastics		O1.1			
	Duroplaste Duroplaste		O1.2			
	Kunststoffe glas- faserverstärkt Plastics glass fibre reinforced	GFK	O1.3			
	Kunststoffe kohle- faserverstärkt Plastics carbon fibre reinforced	CFK	O1.4			

Schnittdaten DR small, medium

Cutting Data DR small, medium



Schnittgeschwindigkeit vc (m/min) / Startwerte mit IK Cutting speed vc (m/min) / Start values with IC								
	MG10	HL3H	AN2H AN4H	AD3H AD4H	DT2H	NP1H	H20	
		40-25						
		35-25						
		22-14						
		18-12						
		40-25						
		30-20						
		22-14						
				30-20				
				18-12				
				12-8				
				6-10				
	70-50				70-50		70-50	
	60-40				60-40		60-40	
						60-40		
						60-40		



Empfehlung DR small Ø 7,6 - 13,1 mm

Recommandation DR small



für Sacklochbohrungen ohne Schnittunterbrechungen, eingesetzt mit IK
for blind holes without cutting interruption, used by IC

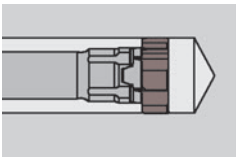

Materialgruppe Material group	Schneidstoff Cutting material	Geometrie Geometry	Verzahnung Flutes
			G= gerade/straight L=linksschräg/left helical
P1	HL3H	A7	G
P2.1 - P2.2	HL3H	A1	G
P2.3 - P3.2	HL3H	A6	G
P4	HL3H	A1	G
P5	HL3H	A7	G
M	HL3H	A7	G
K	HL3H	A1	G
N1	DT2H	A7	G
N2	NP1H	A7	G
N3	DT2H	A7	G
N4	NP1H	A7	G
S	HL3H	A7	G
H	AD3H	A6	G
O	DT2H	A7	G

F

für Durchgangsbohrungen ohne Schnittunterbrechungen, eingesetzt mit IK
for Throung Holes without Cutting Interruption, used by IC

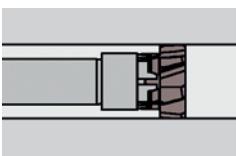

Materialgruppe Material group	Schneidstoff Cutting material	Geometrie Geometry	Verzahnung Flutes
			G= gerade/straight L=linksschräg/left helical
P1	HL3H	B7	L
P2.1 - P2.2	HL3H	B1	L
P2.3 - P3.2	HL3H	B6	L
P4	HL3H	B1	L
P5	HL3H	B7	L
M	HL3H	B7	L
K	HL3H	A1	G
N1	DT2H	B7	L
N2	NP1H	B7	L
N3	DT2H	A7	G
N4	NP1H	A7	G
S	HL3H	A7	L
H	AD3H	A6	G
O	DT2H	A7	L

Vorschub und Aufmaß DR small

Feed rate and stock removal DR small



	DR08 Ø7,6 - 8,1 mm		DR10 Ø8,101 - 9,6 mm		DR11 Ø9,601 - 11,1 mm		DR13 Ø11,101 - 13,1 mm	
	ap	fz	ap	fz	ap	fz	ap	fz
	0,04 - 0,07	0,07 - 0,14	0,05 - 0,08	0,08 - 0,16	0,05 - 0,10	0,10 - 0,18	0,05 - 0,10	0,10 - 0,20
	0,04 - 0,07	0,06 - 0,12	0,05 - 0,08	0,07 - 0,14	0,05 - 0,10	0,08 - 0,16	0,05 - 0,10	0,09 - 0,18
	0,03 - 0,06	0,05 - 0,08	0,04 - 0,08	0,06 - 0,10	0,05 - 0,10	0,08 - 0,12	0,05 - 0,10	0,08 - 0,14
	0,04 - 0,07	0,07 - 0,14	0,05 - 0,08	0,08 - 0,16	0,05 - 0,10	0,10 - 0,18	0,05 - 0,10	0,10 - 0,20
	0,04 - 0,07	0,07 - 0,14	0,05 - 0,08	0,08 - 0,16	0,05 - 0,10	0,10 - 0,18	0,05 - 0,10	0,10 - 0,20
	0,04 - 0,07	0,06 - 0,08	0,05 - 0,08	0,07 - 0,09	0,05 - 0,08	0,08 - 0,10	0,05 - 0,10	0,09 - 0,11
	0,04 - 0,10	0,07 - 0,18	0,05 - 0,10	0,08 - 0,20	0,05 - 0,15	0,10 - 0,22	0,05 - 0,15	0,12 - 0,25
	0,05 - 0,10	0,06 - 0,15	0,05 - 0,12	0,08 - 0,18	0,08 - 0,15	0,1 - 0,22	0,10 - 0,20	0,12 - 0,25
	0,05 - 0,10	0,05 - 0,12	0,05 - 0,12	0,06 - 0,14	0,06 - 0,15	0,08 - 0,18	0,06 - 0,15	0,1 - 0,20
	0,04 - 0,10	0,07 - 0,14	0,04 - 0,10	0,08 - 0,18	0,05 - 0,10	0,08 - 0,20	0,05 - 0,10	0,1 - 0,20
	0,06 - 0,08	0,08 - 0,12	0,08 - 0,10	0,10 - 0,16	0,08 - 0,10	0,14 - 0,18	0,08 - 0,10	0,14 - 0,18
	0,03 - 0,05	0,05 - 0,08	0,03 - 0,06	0,05 - 0,08	0,04 - 0,08	0,05 - 0,10	0,05 - 0,10	0,05 - 0,12
	0,01 - 0,03	0,02 - 0,06	0,01 - 0,04	0,02 - 0,06	0,01 - 0,05	0,02 - 0,08	0,01 - 0,05	0,02 - 0,08
	0,05 - 0,08	0,06 - 0,12	0,05 - 0,08	0,06 - 0,12	0,08 - 0,12	0,06 - 0,12	0,08 - 0,12	0,06 - 0,12



	DR08 Ø7,6 - 8,1 mm		DR10 Ø8,101 - 9,6 mm		DR11 Ø9,601 - 11,1 mm		DR13 Ø11,101 - 13,1 mm	
	ap	fz	ap	fz	ap	fz	ap	fz
	0,04 - 0,07	0,08 - 0,16	0,05 - 0,08	0,09 - 0,18	0,05 - 0,10	0,11 - 0,20	0,05 - 0,10	0,12 - 0,22
	0,04 - 0,07	0,07 - 0,13	0,05 - 0,08	0,08 - 0,16	0,05 - 0,10	0,09 - 0,18	0,05 - 0,10	0,10 - 0,20
	0,03 - 0,06	0,06 - 0,09	0,04 - 0,08	0,07 - 0,11	0,05 - 0,10	0,09 - 0,13	0,05 - 0,10	0,09 - 0,16
	0,04 - 0,07	0,08 - 0,16	0,05 - 0,08	0,09 - 0,18	0,05 - 0,10	0,11 - 0,18	0,05 - 0,10	0,12 - 0,22
	0,04 - 0,07	0,08 - 0,16	0,05 - 0,08	0,09 - 0,18	0,05 - 0,10	0,11 - 0,20	0,05 - 0,10	0,11 - 0,22
	0,04 - 0,07	0,07 - 0,09	0,05 - 0,08	0,08 - 0,10	0,05 - 0,08	0,09 - 0,11	0,05 - 0,10	0,10 - 0,12
	0,04 - 0,10	0,07 - 0,18	0,05 - 0,10	0,08 - 0,20	0,05 - 0,15	0,10 - 0,22	0,05 - 0,15	0,12 - 0,25
	0,05 - 0,10	0,07 - 0,17	0,05 - 0,12	0,09 - 0,20	0,08 - 0,15	0,11 - 0,25	0,10 - 0,20	0,13 - 0,28
	0,05 - 0,10	0,06 - 0,13	0,05 - 0,12	0,07 - 0,16	0,06 - 0,15	0,09 - 0,20	0,06 - 0,15	0,11 - 0,22
	0,04 - 0,10	0,08 - 0,16	0,04 - 0,10	0,09 - 0,20	0,05 - 0,10	0,09 - 0,22	0,05 - 0,10	0,1 - 0,20
	0,06 - 0,08	0,09 - 0,13	0,08 - 0,10	0,11 - 0,18	0,08 - 0,10	0,16 - 0,20	0,08 - 0,10	0,16 - 0,20
	0,03 - 0,05	0,06 - 0,09	0,03 - 0,06	0,05 - 0,08	0,04 - 0,08	0,05 - 0,10	0,05 - 0,10	0,05 - 0,12
	0,01 - 0,03	0,02 - 0,06	0,01 - 0,04	0,02 - 0,06	0,01 - 0,05	0,02 - 0,08	0,01 - 0,05	0,02 - 0,08
	0,05 - 0,08	0,06 - 0,12	0,05 - 0,08	0,06 - 0,12	0,08 - 0,12	0,06 - 0,12	0,08 - 0,12	0,06 - 0,12

für Sacklochbohrungen ohne Schnittunterbrechungen, eingesetzt mit IK
for blind holes without cutting interruption, used by IC

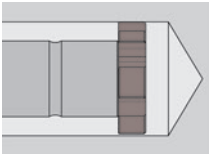

Materialgruppe Material group	Schneidstoff Cutting material	Geometrie Geometry	Verzahnung Flutes
			G= gerade/straight L=linksschräg/left helical
P1	HL3H	A7	G
P2.1 - P2.2	HL3H	A1	G
P2.3 - P3.2	HL3H	A6	G
P4	HL3H	A1	G
P5	HL3H	A7	G
M	HL3H	A7	G
K	HL3H	A1	G
N1	DT2H	A7	G
N2	NP1H	A7	G
N3	DT2H	A7	G
N4	NP1H	A7	G
S	HL3H	A7	G
H	AD3H	A6	G
O	DT2H	A7	G

F

für Durchgangsbohrungen ohne Schnittunterbrechungen, eingesetzt mit IK
for Throung Holes without Cutting Interruption, used by IC

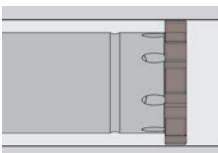

Materialgruppe Material group	Schneidstoff Cutting material	Geometrie Geometry	Verzahnung Flutes
			G= gerade/straight L=linksschräg/left helical
P1	HL3H	B7	L
P2.1 - P2.2	HL3H	B1	L
P2.3 - P3.2	HL3H	B6	L
P4	HL3H	B1	L
P5	HL3H	B7	L
M	HL3H	B7	L
K	HL3H	A1	G
N1	DT2H	B7	L
N2	NP1H	B7	L
N3	DT2H	A7	G
N4	NP1H	A7	G
S	HL3H	A7	L
H	AD3H	A6	G
O	DT2H	A7	L

Vorschub und Aufmaß DR medium

Feed rate and stock removal DR medium





	DR016 Ø11,9 - 15,6 mm		DR019 - DR024 Ø15,601 - 23,6 mm		DR029 - DR036 Ø23,601 - 35,6 mm		DR044 - DR141 Ø35,601 - 140,6 mm	
	ap	fz	ap	fz	ap	fz	ap	fz
	0,04 - 0,10	0,07 - 0,18	0,06 - 0,12	0,10 - 0,20	0,08 - 0,15	0,12 - 0,20	0,10 - 0,18	0,12 - 0,20
	0,04 - 0,10	0,06 - 0,14	0,06 - 0,12	0,09 - 0,18	0,08 - 0,15	0,11 - 0,18	0,10 - 0,18	0,11 - 0,18
	0,03 - 0,08	0,05 - 0,12	0,04 - 0,10	0,08 - 0,14	0,05 - 0,12	0,10 - 0,14	0,10 - 0,15	0,10 - 0,14
	0,04 - 0,10	0,07 - 0,18	0,05 - 0,12	0,10 - 0,20	0,07 - 0,15	0,12 - 0,20	0,10 - 0,18	0,12 - 0,20
	0,04 - 0,10	0,07 - 0,18	0,05 - 0,12	0,10 - 0,20	0,06 - 0,13	0,12 - 0,20	0,07 - 0,15	0,12 - 0,20
	0,03 - 0,08	0,06 - 0,14	0,04 - 0,10	0,08 - 0,16	0,05 - 0,12	0,10 - 0,16	0,06 - 0,12	0,10 - 0,16
	0,06 - 0,15	0,10 - 0,25	0,10 - 0,20	0,12 - 0,25	0,10 - 0,25	0,12 - 0,25	0,12 - 0,25	0,12 - 0,25
	0,06 - 0,12	0,08 - 0,22	0,1 - 0,15	0,12 - 0,25	0,12 - 0,18	0,14 - 0,25	0,12 - 0,20	0,14 - 0,25
	0,06 - 0,12	0,07 - 0,18	0,1 - 0,15	0,10 - 0,20	0,12 - 0,18	0,12 - 0,20	0,12 - 0,20	0,12 - 0,20
	0,03 - 0,10	0,10 - 0,20	0,04 - 0,12	0,10 - 0,20	0,05 - 0,15	0,12 - 0,20	0,08 - 0,18	0,12 - 0,20
	0,05 - 0,10	0,12 - 0,18	0,06 - 0,12	0,14 - 0,18	0,08 - 0,14	0,14 - 0,18	0,10 - 0,18	0,14 - 0,18
	0,03 - 0,05	0,05 - 0,12	0,03 - 0,08	0,05 - 0,12	0,04 - 0,10	0,06 - 0,12	0,05 - 0,12	0,06 - 0,12
	0,01 - 0,03	0,02 - 0,08	0,01 - 0,04	0,02 - 0,08	0,02 - 0,05	0,02 - 0,08	0,02 - 0,05	0,02 - 0,08
	0,05 - 0,08	0,05 - 0,12	0,06 - 0,10	0,06 - 0,12	0,08 - 0,12	0,06 - 0,12	0,10 - 0,15	0,06 - 0,12

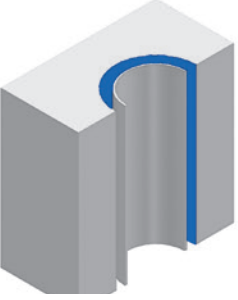
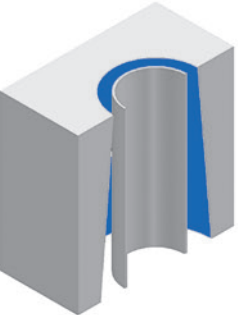
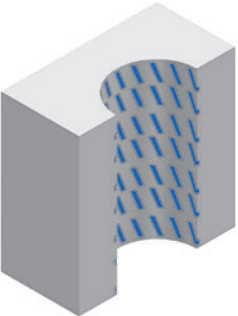

	DR016 Ø11,9 - 15,6 mm		DR019 - DR024 Ø15,601 - 23,6 mm		DR029 - DR036 Ø23,601 - 35,6 mm		DR044 - DR141 Ø35,601 - 140,6 mm	
	ap	fz	ap	fz	ap	fz	ap	fz
	0,04 - 0,10	0,08 - 0,20	0,06 - 0,12	0,11 - 0,22	0,08 - 0,15	0,14 - 0,22	0,10 - 0,18	0,14 - 0,22
	0,04 - 0,10	0,07 - 0,18	0,06 - 0,12	0,10 - 0,20	0,08 - 0,15	0,12 - 0,20	0,10 - 0,18	0,12 - 0,20
	0,03 - 0,08	0,06 - 0,14	0,04 - 0,10	0,09 - 0,16	0,05 - 0,12	0,11 - 0,16	0,10 - 0,15	0,11 - 0,16
	0,04 - 0,10	0,08 - 0,20	0,05 - 0,12	0,11 - 0,22	0,07 - 0,15	0,14 - 0,22	0,10 - 0,18	0,14 - 0,22
	0,04 - 0,10	0,08 - 0,20	0,05 - 0,12	0,11 - 0,22	0,06 - 0,13	0,14 - 0,22	0,07 - 0,15	0,14 - 0,22
	0,03 - 0,08	0,07 - 0,14	0,04 - 0,10	0,09 - 0,18	0,05 - 0,12	0,11 - 0,18	0,06 - 0,12	0,11 - 0,18
	0,06 - 0,15	0,10 - 0,25	0,10 - 0,20	0,12 - 0,25	0,10 - 0,25	0,12 - 0,25	0,12 - 0,25	0,12 - 0,25
	0,06 - 0,12	0,10 - 0,25	0,1 - 0,15	0,15 - 0,30	0,12 - 0,18	0,16 - 0,30	0,12 - 0,20	0,16 - 0,30
	0,06 - 0,12	0,10 - 0,20	0,1 - 0,15	0,11 - 0,22	0,12 - 0,18	0,14 - 0,22	0,12 - 0,20	0,14 - 0,22
	0,03 - 0,10	0,10 - 0,20	0,04 - 0,12	0,10 - 0,20	0,05 - 0,15	0,12 - 0,20	0,08 - 0,18	0,12 - 0,20
	0,05 - 0,10	0,12 - 0,18	0,06 - 0,12	0,16 - 0,20	0,08 - 0,14	0,16 - 0,20	0,10 - 0,18	0,16 - 0,20
	0,03 - 0,05	0,05 - 0,12	0,03 - 0,08	0,06 - 0,14	0,04 - 0,10	0,07 - 0,14	0,05 - 0,12	0,07 - 0,14
	0,01 - 0,03	0,02 - 0,08	0,01 - 0,04	0,02 - 0,08	0,02 - 0,05	0,02 - 0,08	0,02 - 0,05	0,02 - 0,08
	0,05 - 0,08	0,05 - 0,12	0,06 - 0,10	0,06 - 0,12	0,08 - 0,12	0,06 - 0,12	0,10 - 0,15	0,06 - 0,12

Fehler Fault	Behebung Remedy
<p>Bohrung ist zu groß Hole too large</p> 	<ol style="list-style-type: none"> 1. Rundlauffehler reduzieren, evtl. Ausgleichshalter einsetzen 2. Schnittgeschwindigkeit reduzieren 3. Vorschub erhöhen, Mischverhältnis KSS erhöhen 4. Spantiefe reduzieren 5. Verschleiß überprüfen (Aufbauschneide) 6. Werkzeug-\varnothing kontrollieren <ol style="list-style-type: none"> 1. Reduce runout error and use compensation holder 2. Reduce cutting speed 3. Increase feed rate, increase coolant mix 4. Reduce depth of cut 5. Check tool wear (especiall build-up edges) 6. Control reamer-\varnothing
<p>Bohrung ist konisch Tapered hole</p> 	<ol style="list-style-type: none"> 1. Rundlauffehler reduzieren, evtl. Ausgleichshalter einsetzen 2. Schnittgeschwindigkeit und Vorschub reduzieren, KSS überprüfen 3. Vorbearbeitung verbessern 4. Aufspannung verbessern 5. Werkstück messen im gespannten und ungespanntem Zustand 6. Spänefluss prüfen <ol style="list-style-type: none"> 1. Reduce runout error and use compensation holder 2. Reduce cutting speed and feed, check coolant mix 3. Improve pre-machining 4. Improve workpiece clamping 5. Measure bore in clamped and unclamped condition 6. Check chip flow
<p>Bohrung zeigt Rattermarken Hole shows chatter marks</p> 	<ol style="list-style-type: none"> 1. Rundlauffehler reduzieren, evtl. Ausgleichshalter einsetzen 2. Anschnittgeometrie wechseln 3. Aufspannung verbessern 4. Schnittgeschwindigkeit reduzieren 5. Vorschub erhöhen <ol style="list-style-type: none"> 1. Reduce runout error and use compensation holder 2. Change chamfer angle 3. Improve workpiece clamping 4. Reduce cutting speed 5. Increase feed rate

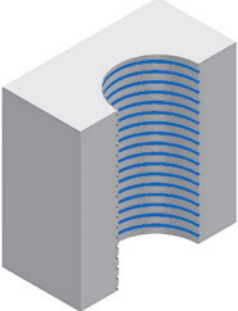
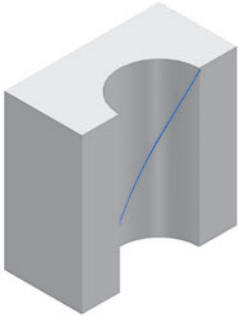
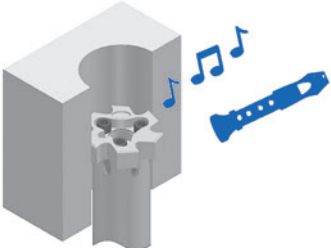
F

Fehler Fault	Behebung Remedy
<p>Oberflächengüte ungenügend Surface quality unsatisfactory</p> 	<ol style="list-style-type: none"> 1. Verschleiß prüfen 2. Rundlauffehler reduzieren, evtl. Ausgleichshalter einsetzen, Schnittdaten überprüfen 3. Werkzeug mit IKZ verwenden 4. Mischverhältnis KSS erhöhen <ol style="list-style-type: none"> 1. Check insert wear 2. Reduce runout error and use compensation holder, check cutting data 3. Use tool with internal coolant supply 4. Increase coolant mix
<p>Rückzugriefen in der Bohrung Retention marks in hole</p> 	<ol style="list-style-type: none"> 1. Rundlauffehler reduzieren, evtl. Ausgleichshalter einsetzen 2. Verschleiß überprüfen (Aufbauschneiden) 3. Spantiefe reduzieren 4. Schärfere Geometrie einsetzen 5. Rückzugsgeschwindigkeit reduzieren <ol style="list-style-type: none"> 1. Reduce runout error and use compensation holder 2. Check insert wear (build-up edges) 3. Reduce depth of cut 4. Use a sharper geometry 5. Reduce pull back feed
<p>Werkzeug klemmt Reamer jams</p> 	<ol style="list-style-type: none"> 1. Mischverhältnis KSS reduzieren 2. Spantiefe erhöhen 3. Verschleiß prüfen 4. Anschnittgeometrie wechseln <ol style="list-style-type: none"> 1. Reduce coolant mix 2. Increase depth of cut 3. Check insert wear 4. Change chamfer angle
<p>Bohrung ist zu klein Hole too small</p> 	<ol style="list-style-type: none"> 1. Schneide ersetzen 2. Mischverhältnis KSS reduzieren 3. Spantiefe erhöhen 4. Schnittgeschwindigkeit erhöhen 5. Vorschub reduzieren <ol style="list-style-type: none"> 1. Change insert 2. Reduce coolant mix 3. Increase depth of cut 4. Increase cutting speed 5. Reduce feed rate



F



URMA



G

System-Aufnahme URMA

Modulare Komponenten
Beta-Modul

System Adaptors URMA

Modular Components
Beta-Modul

Übersicht
Overview

Seite/Page
197

System-Aufnahme
URMA
System Adaptors URMA
BH/BD/BT



Seite/Page
198



Seite/Page
199



Seite/Page
200

Verlängerung
Extension
B13

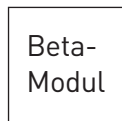

Seite/Page
201

Reduzierung
Reducer
B12

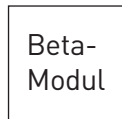

Seite/Page
202

Systemaufnahme Beta-Modul
System adaptor Beta-Modul

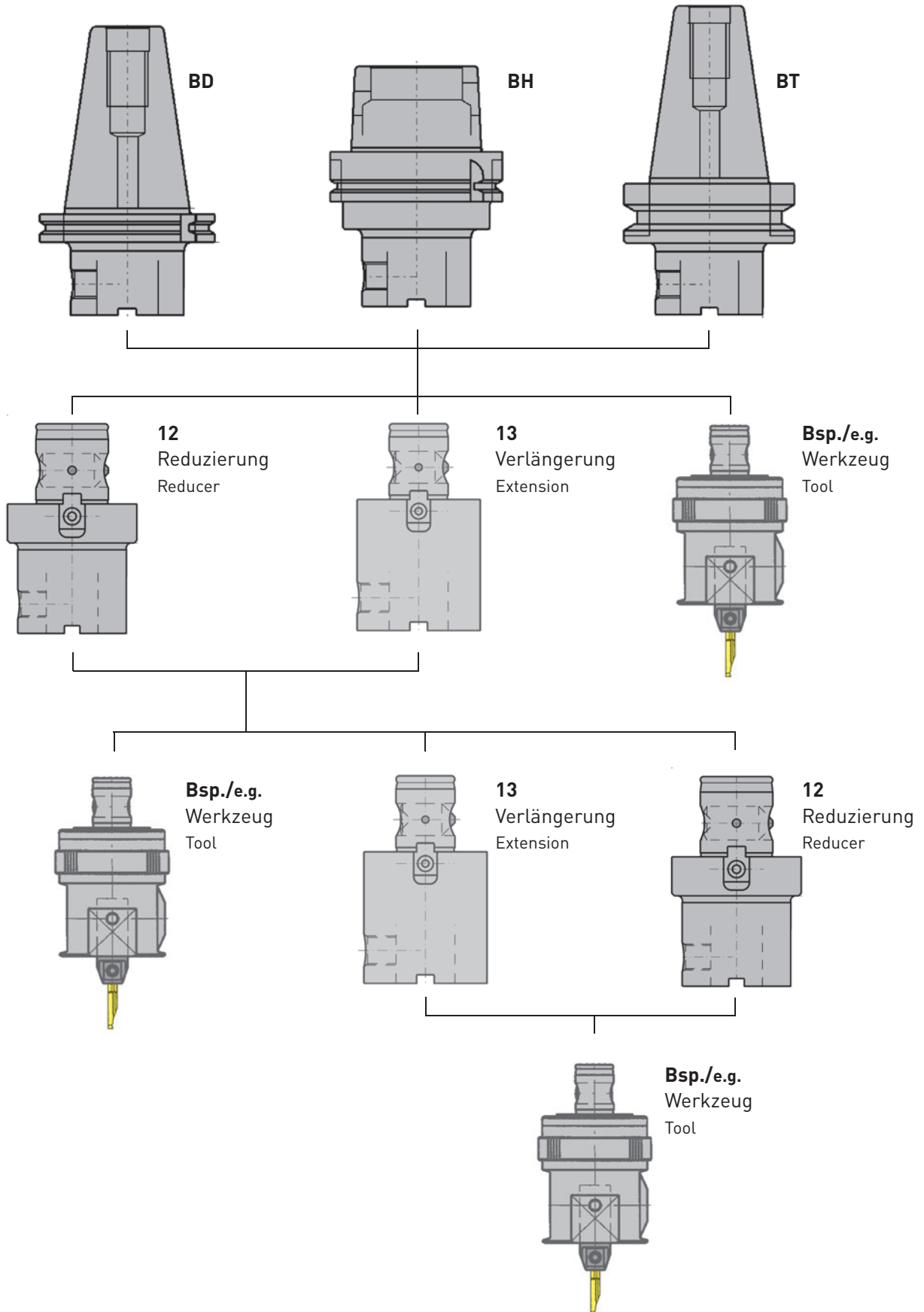

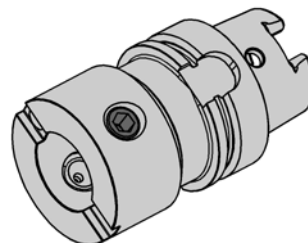
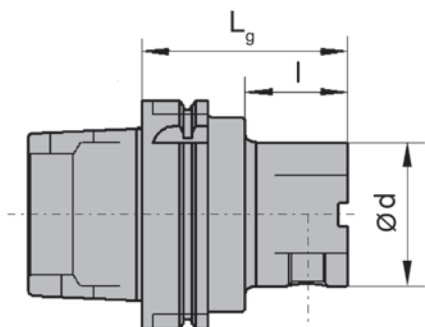
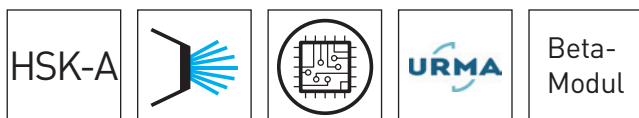

Bestellnummer Part number	Lg	l	d	Beta-Modul	Gewicht [kg] Weight [kg]	System
BH10 63A 25 055	55	29	25	25	0,9	HSK-A 63
BH10 63A 32 060	60	34	32	32	1	HSK-A 63
BH10 63A 40 065	65	23	42	40	1,1	HSK-A 63
BH10 63A 50 070	70	28	50	50	1,5	HSK-A 63
BH10 63A 63 080	80	-	63	63	1,5	HSK-A 63
BH10 100A 32 060	60	31	32	32	2,3	HSK-A 100
BH10 100A 40 080	80	35	42	40	3,1	HSK-A 100
BH10 100A 50 080	80	35	50	50	3,2	HSK-A 100
BH10 100A 63 080	80	35	63	63	3,3	HSK-A 100
BH10 100A 80 090	90	45	80	80	4	HSK-A 100
BH10 100A 100 100	100	-	100	100	5	HSK-A 100

Das Kühlmittelrohr ist nicht im Lieferumfang enthalten - bitte separat bestellen! Kapitel Zubehör
Coolant tube is not included - separate order required! Chapter Additional Equipment

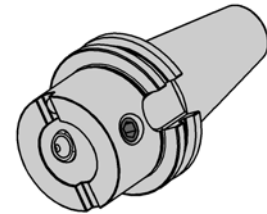
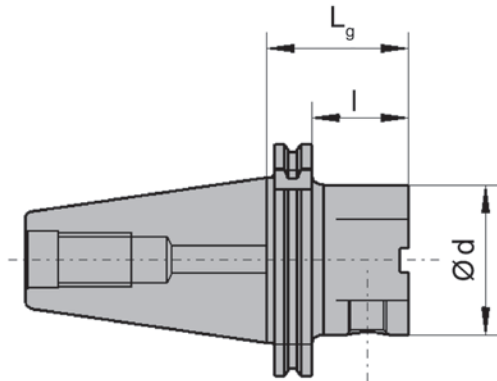

Bestellnummer Part number	Lg	l	d	Beta-Modul	Gewicht [kg] Weight [kg]	System
BD10 40A 25 050	50	31	25	25	0,8	SK 40
BD10 40A 32 050	50	31	32	32	0,9	SK 40
BD10 40A 40 035	35	16	42	40	0,9	SK 40
BD10 40A 40 050	50	31	42	40	1,1	SK 40
BD10 40A 50 050	50	31	50	50	1,2	SK 40
BD10 40A 63 065	65	46	63	63	1,5	SK 40
BD10 40A 63 090	90	70	63	63	2	SK 40
BD10 50A 25 060	60	41	25	25	2,8	SK 50
BD10 50A 32 060	60	41	32	32	2,9	SK 50
BD10 50A 40 060	60	41	42	40	3	SK 50
BD10 50A 50 060	60	41	50	50	3,2	SK 50
BD10 50A 63 060	60	41	63	63	3,3	SK 50
BD10 50A 80 070	70	51	80	80	4	SK 50
BD10 50A 100 115	115	96	50	100	6,9	SK 50



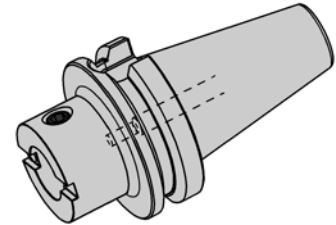
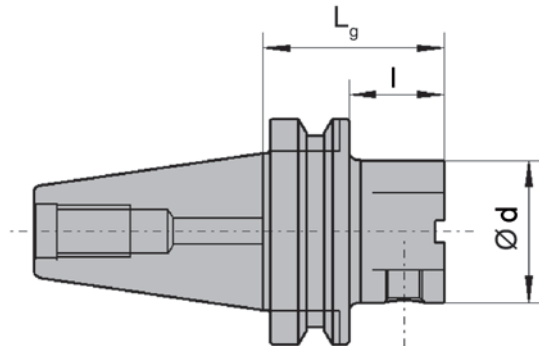

Bestellnummer Part number	Lg	l	d	Beta-Modul	Gewicht [kg] Weight [kg]	System
BT10 40A 25 060	60	33	25	25	0,8	JIS-BT 40
BT10 40A 32 060	60	33	32	32	0,9	JIS-BT 40
BT10 40A 40 028	28	1	42	40	0,9	JIS-BT 40
BT10 40A 40 060	60	33	42	40	1,2	JIS-BT 40
BT10 40A 50 060	60	33	50	50	1,3	JIS-BT 40
BT10 40A 63 055	55	28	63	63	1,4	JIS-BT 40
BT10 40A 63 070	70	43	63	63	1,7	JIS-BT 40
BT10 50A 32 070	70	32	32	32	3,7	JIS-BT 50
BT10 50A 40 070	70	32	42	40	3,9	JIS-BT 50
BT10 50A 50 070	70	32	50	50	4,1	JIS-BT 50
BT10 50A 63 080	80	42	63	63	4,3	JIS-BT 50
BT10 50A 80 100	100	62	80	80	5,5	JIS-BT 50
BT10 50A 100 100	110	72	100	100	7	JIS-BT 50

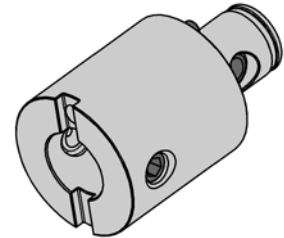
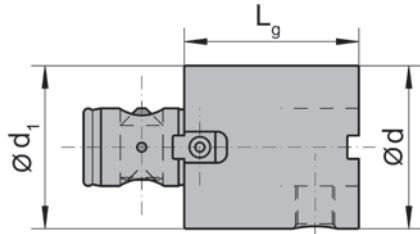
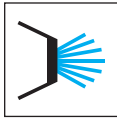

Bestellnummer Part number	L _g	d	d ₁	Beta-Modul MS	Beta-Modul WS	Gewicht [kg] Weight [kg]
B13 25 25 045	45	25	25	25	25	0,2
B13 25 25 070	70	25	25	25	25	0,3
B13 32 32 035	35	32	32	32	32	0,2
B13 32 32 070	70	32	32	32	32	0,4
B13 40 40 045	45	42	42	40	40	0,4
B13 40 40 070	70	42	42	40	40	0,7
B13 50 50 065	65	50	50	50	50	1
B13 50 50 100	100	50	50	50	50	1,5
B13 63 63 060	60	63	63	63	63	1,3
B13 63 63 125	125	63	63	63	63	2,9



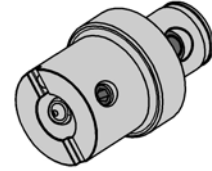
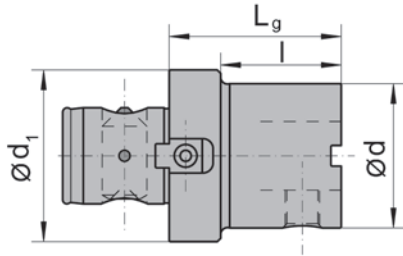

Bestellnummer Part number	Lg	l	d	d ₁	Beta-Modul MS	Beta-Modul WS	Gewicht [kg] Weight [kg]
B12 32 25 040	40	25	25	32	32	25	0,2
B12 40 25 040	40	25	25	42	40	25	0,3
B12 40 32 045	45	30	32	42	40	32	0,3
B12 50 40 050	50	35	42	50	50	40	0,5
B12 63 25 045	45	25	25	63	63	25	0,7
B12 63 32 050	50	30	32	63	63	32	0,9
B12 63 40 055	55	35	42	63	63	40	1,1

HD

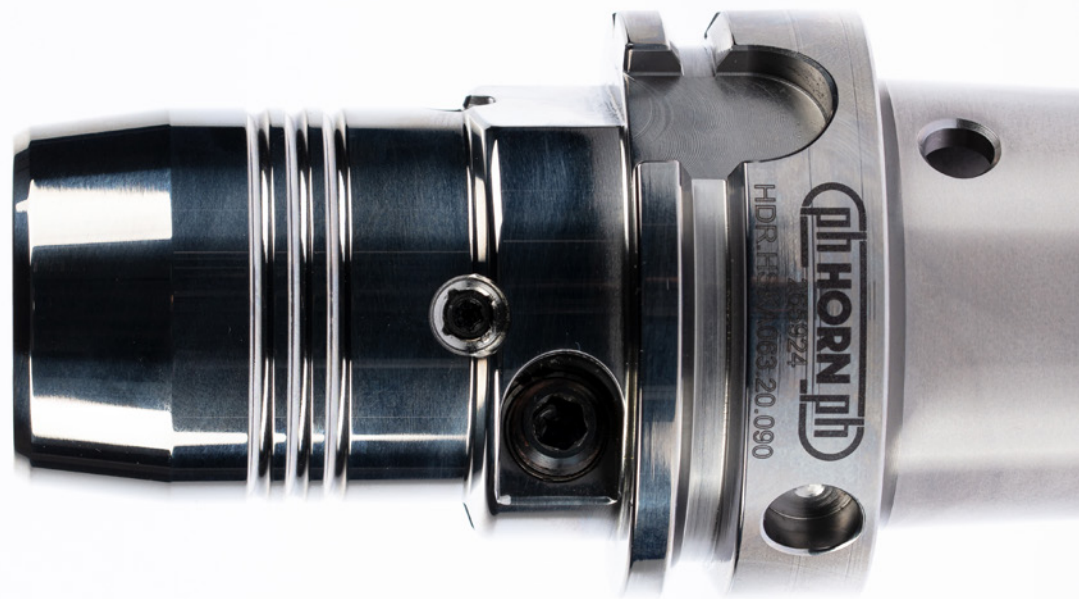

H

Hydrodehnspannfutter

Ausführung:

- HD classic
- HD Ecompact
- HD slim4X
- HD zero
- HD zero-K

Hydraulic Expansion Toolholder

Version:

- HD classic
- HD Ecompact
- HD slim4X
- HD zero
- HD zero-K

Übersicht
Overview

Seite/Page
206-207

Hydrodehnspannfutter
classic
Hydraulic Expansion Toolholder
classic
HDC

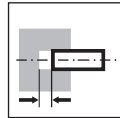

Seite/Page
208-209

Hydrodehnspannfutter
Ecompact
Hydraulic Expansion Toolholder
Ecompact
HDE

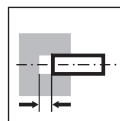

Seite/Page
210-212

Hydrodehnspannfutter
slim4X
Hydraulic Expansion Toolholder
slim4X
HDS4X



Seite/Page
213-214

Hydrodehnspannfutter
zero
Hydraulic Expansion Toolholder
zero
HDR

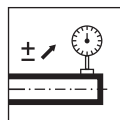

Seite/Page
215-218

Hydrodehnspannfutter
zero-K
Hydraulic Expansion Toolholder
zero-K
HDRK

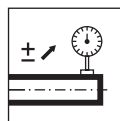

Seite/Page
219

Zwischenbüchse
Intermediate Sleeve
HDZB

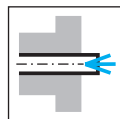

Seite/Page
220

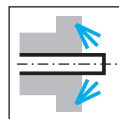

Seite/Page
221

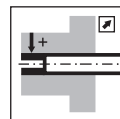

Seite/Page
222



H



HDC

"Das Original" in schlanker Ausführung nach DIN. Vielseitig einsetzbar, ob beim Fräsen, Bohren, Senken, Gewindefräsen oder in der HSC- Bearbeitung

- Mit umfangreicherer Produktreihe
- Rundlauf- und Wiederholgenauigkeit < 0,003 mm
- Hervorragende Schwingungsdämpfung
- Flexibler Spannungsbereich durch Zwischenbüchsen
- Axiale Längenvoreinstellung
- Serienmäßig feingewuchtet

"The original" in slim design according DIN.

Versatile use - whether milling, reaming, boring, chamfering, thread milling, or high-speed machining.

- Offering exceptional versatility for a wide range of applications
- Runout and repeat accuracy < 0.003 mm
- Excellent vibration damping
- Versatile clamping range due to intermediate sleeves
- Axial length pre-adjustment
- Standard fine-balanced



HDE

Robuste, kurze Ausführung für Volumenzerspanung, Bohren, Reiben und zum Gewindefräsen.

- Höchste Drehmomente, jetzt bis 900 Nm bei Ø 20 unter trockener Spann-Bedingung, 520 Nm bei öligem Werkzeugschaft
- Exzellentes Preis-Leistungs-Verhältnis
- Rundlauf- und Wiederholgenauigkeit < 0,003 mm
- Axiale Längenvoreinstellung

Robust and short design for universal use in volume machining, milling, boring, reaming, and thread-milling

- Highest torques, now up to 900 Nm on Ø 20 mm under dry clamping conditions, 520 Nm on oily tool shanks
- Excellent price/performance ratio
- Constant runout and repeat accuracy < 0.003 mm
- Axial length pre-adjustment



HDS4X

Schlanke Ausführung, besonders geeignet für axiale Bearbeitung. Äußere Abmessungen sind entsprechend zu Warmschrumpffuttern nach DIN 69882-8.

- Nicht in Schrumpfgeräten verwenden
- Schlanke Bauweise
- Kurze und lange Ausführung
- Hervorragende Schwingungsdämpfung
- Axiale Längenvoreinstellung

Slim design, recommended for axial machining. Outer dimensions are corresponding to heat shrink chucks according to DIN 69882-8.

- Do not use in shrink machines
- Slim design
- Short and long version
- Excellent vibration damping
- Axial length pre-adjustment



HDR

μ -genau! Im Handumdrehen auf 0,000 mm
Das im Rundlauf einstellbare Hydrodehnspannfutter Typ HDR ist der Profi für enge Toleranzen beim Bohren, Reiben und überall dort, wo ein perfekter Rundlauf gefordert ist.

- Dauerhafter Rundlauf auf 0 μm einstellbar
- Einfache Handhabung
- Perfekte Schwingungsdämpfung

Micron precise! The runout adjustable hydraulic expansion tool holder Type HDR is the professional tool holder for tight tolerances for boring, reaming or wherever perfect runout accuracy is a must. This enables even minimal concentricity errors with tools, spindle mounts, and the spindles to be individually compensated.

- Constant runout accuracy can be adjusted to 0 μm
- Easy handling
- Perfect vibration damping



HDRK

Extrakurz mit Rundrichtfunktion vom Typ HDR. Kürzere Bauweise durch Weglassen der Längenverstellung. Ausführung HSK-C63 trägt ebenfalls zur Längenreduzierung bei. Insbesondere bei engen Platzverhältnissen und ungünstigen Schwingungen eine Alternative.

- Dauerhafter Rundlauf auf 0 μm einstellbar
- Einfache Handhabung
- Perfekte Schwingungsdämpfung
- Ohne Längenverstellung

Extra short with circular directional function of type HDR. Shorter design by omitting the length adjustment. Type HSK-C63 also contributes to the length reduction. An alternative, especially for tight spaces and unfavourable vibrations

- Constant runout accuracy can be adjusted to 0 μm
- Easy handling
- Perfect vibration damping
- Without length adjustment

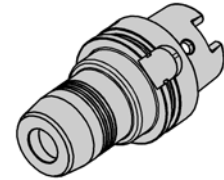
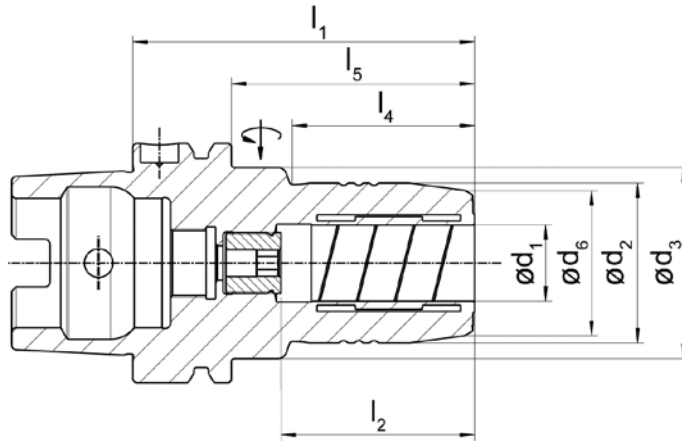

Bestellnummer Part number	d ₁	d ₂	d ₃	d ₆	l ₁	l ₂	l ₄	l ₅	Gewicht [kg] Weight [kg]	M _{min} [Nm]	System
HDC.HSKA050.06.070	6	26	40	22	70	37	28	44	0,7	16	HSK-A 50
HDC.HSKA050.08.070	8	28	40	24	70	37	28	44	0,7	23	HSK-A 50
HDC.HSKA050.10.075	10	30	40	26	75	41	34	49	0,7	45	HSK-A 50
HDC.HSKA050.12.085	12	32	40	28	85	46	44	59	0,8	90	HSK-A 50
HDC.HSKA050.16.090	16	38	53	34	90	49	30	64	1,1	185	HSK-A 50
HDC.HSKA050.20.090	20	42	60	38	90	51	29	64	1,1	330	HSK-A 50
HDC.HSKA063.06.070	6	26	50	22	70	37	24	44	1	16	HSK-A 63
HDC.HSKA063.08.070	8	28	50	24	70	37	25	44	1	23	HSK-A 63
HDC.HSKA063.10.080	10	30	50	26	80	41	35	54	1,1	45	HSK-A 63
HDC.HSKA063.12.085	12	32	50	28	85	46	40	59	1,1	90	HSK-A 63
HDC.HSKA063.16.090	16	38	50	34	90	49	46	64	1,2	185	HSK-A 63
HDC.HSKA063.20.090	20	42	50	38	90	51	48	64	1,3	330	HSK-A 63
HDC.HSKA063.25.120	25	57	63	51	120	57	-	94	2,2	400	HSK-A 63
HDC.HSKA100.06.075	6	26	50	22	75	37	26	46	2,5	16	HSK-A 100
HDC.HSKA100.08.075	8	28	50	24	75	37	26	46	2,5	23	HSK-A 100
HDC.HSKA100.10.090	10	30	50	26	90	41	42	61	2,5	45	HSK-A 100
HDC.HSKA100.12.095	12	32	50	28	95	46	47	66	2,6	90	HSK-A 100
HDC.HSKA100.16.100	16	38	50	34	100	49	53	71	2,7	185	HSK-A 100
HDC.HSKA100.20.105	20	42	50	38	105	51	59	76	2,8	330	HSK-A 100
HDC.HSKA100.25.110	25	57	63	51	110	57	62,5	81	3,7	400	HSK-A 100

Das Kühlmittelrohr ist nicht im Lieferumfang enthalten - bitte separat bestellen! Kapitel Zubehör
Coolant tube is not included - separate order required! Chapter Additional Equipment

Hydrodehnspannfutter classic

Hydraulic Expansion Toolholder classic

HDC

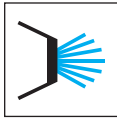

SK-AB

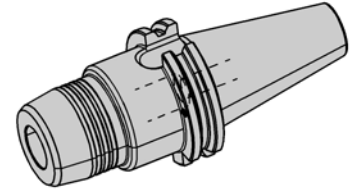
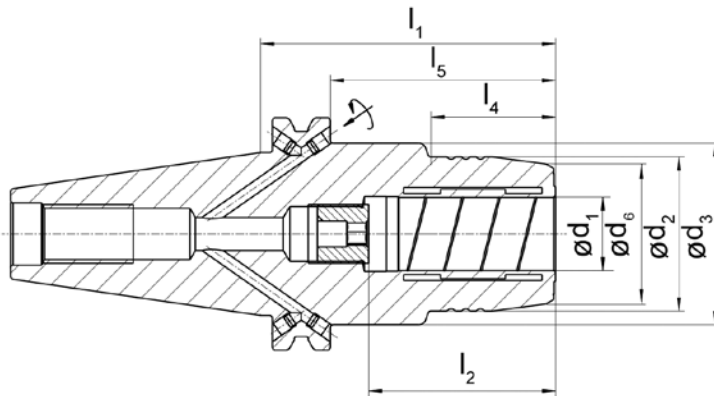

Bestellnummer Part number	d ₁	d ₂	d ₃	d ₆	l ₁	l ₂	l ₄	l ₅	Gewicht [kg] Weight [kg]	M _{min} [Nm]	System
HDC.SK40.06.080	6	26	49,5	22	80,5	37	29,5	61,5	1,4	16	SK 40
HDC.SK40.08.080	8	28	49,5	24	80,5	37	30	61,5	1,4	23	SK 40
HDC.SK40.10.080	10	30	49,5	26	80,5	41	31	61,5	1,4	45	SK 40
HDC.SK40.12.080	12	32	49,5	28	80,5	46	31,5	61,5	1,4	90	SK 40
HDC.SK40.16.080	16	38	49,5	34	80,5	49	33	61,5	1,4	185	SK 40
HDC.SK40.20.080	20	42	49,5	38	80,5	51	34	61,5	1,4	330	SK 40
HDC.SK40.25.080	25	55	66	53	80,5	57	22	61,5	1,8	330	SK 40
HDC.SK50.20.080	20	42	49,5	38	80,5	51	34	61,5	3,3	330	SK 50

H

Hydrodehnspannfutter Ecompact

Hydraulic Expansion Toolholder Ecompact

HDE

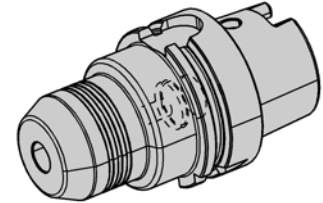
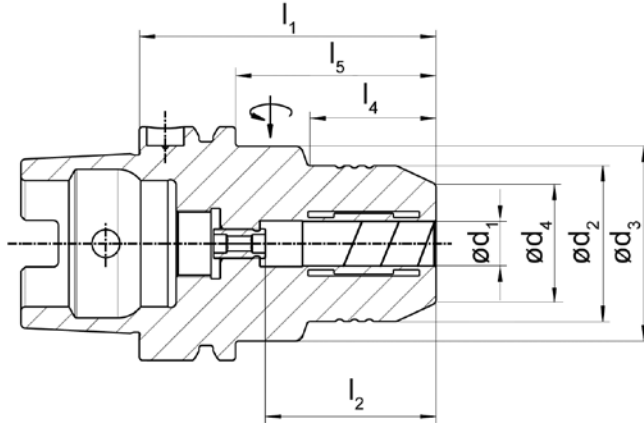

Bestellnummer Part number	d ₁	d ₂	d ₃	d ₄	l ₁	l ₂	l ₄	l ₅	Gewicht [kg] Weight [kg]	M _{min} [Nm]	System
HDE.HSKA063.12.080	12	42	52,5	32	80	46	34	54	1,25	110	HSK-A 63
HDE.HSKA063.16.080	16	53	-	38	80	51	-	54	1,3	350	HSK-A 63
HDE.HSKA063.20.080	20	52,5	-	38	80	51	-	54	1,32	520	HSK-A 63
HDE.HSKA100.20.090	20	52,5	-	38	90	51	-	54	2,8	520	HSK-A 100
HDE.HSKA100.32.100	32	72	-	58,5	100	61	-	71,05	3,8	900	HSK-A 100

Das Kühlmittelrohr ist nicht im Lieferumfang enthalten - bitte separat bestellen!
Coolant tube is not included - separate order required!

H

Hydrodehnspannfutter Ecompact

Hydraulic Expansion Toolholder Ecompact

HDE

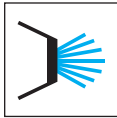

SK-AB

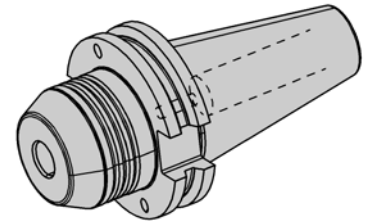
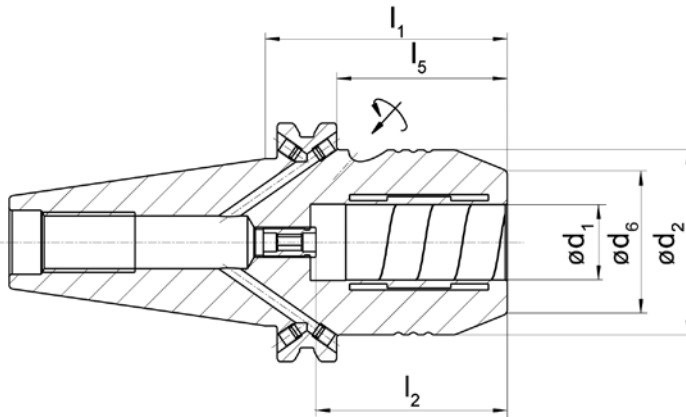

Bestellnummer Part number	d ₁	d ₂	d ₆	l ₁	l ₂	l ₅	Gewicht [kg] Weight [kg]	M _{min} [Nm]	System
HDE.SK40.12.050	12	42	32	50	46	31	1,1	110	SK 40
HDE.SK40.16.064	16	49,25	38	64,5	51	45,45	1,2	350	SK 40
HDE.SK40.20.064	20	49,25	38	64,5	51	45,5	1,3	520	SK 40
HDE.SK50.12.050	12	42	32	50	46	31	2,8	110	SK 50
HDE.SK50.20.064	20	49,25	38	64,5	51	45,5	3,1	520	SK 50
HDE.SK50.32.081	32	72	58,5	81	61	62	4,1	900	SK 50

H

Hydrodehnspannfutter Ecompact

Hydraulic Expansion Toolholder Ecompact

HDE

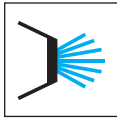

PSC

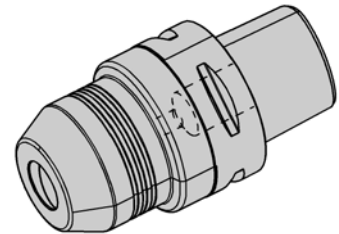
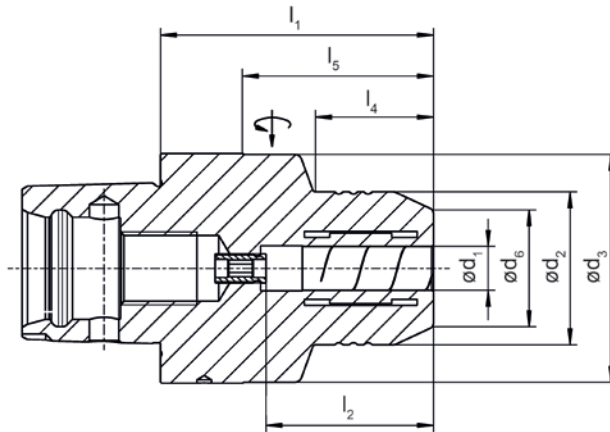

Bestellnummer Part number	d ₁	d ₂	d ₃	d ₆	l ₁	l ₂	l ₄	l ₅	Gewicht [kg] Weight [kg]	M _{min} [Nm]	System
HDE.C4.12.065	12	39,5	39,5	32	65	46	-	44	0,65	110	PSC 40
HDE.C4.20.083	20	45,5	45,5	38	83	51	-	62,4	0,85	440	PSC 40
HDE.C5.12.070	12	42	49,5	32	70	46	33	50	0,9	110	PSC 50
HDE.C5.20.075	20	49,5	49,5	38	75	51	-	54	1	440	PSC 50
HDE.C6.12.075	12	42	62,5	32	75	46	33	53	1,5	110	PSC 63
HDE.C6.20.080	20	52,5	62,5	38	80	51	41	57,4	1,6	440	PSC 63
HDE.C6.32.090	32	62,5	62,5	58,5	90	61	-	67	1,95	800	PSC 63

H

Hydrodehnspannfutter slim4X

Hydraulic Expansion Toolholder slim4X

HDS4X **ph HORN ph**

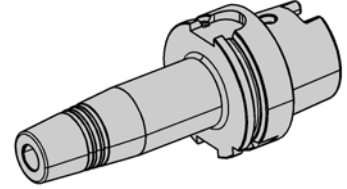
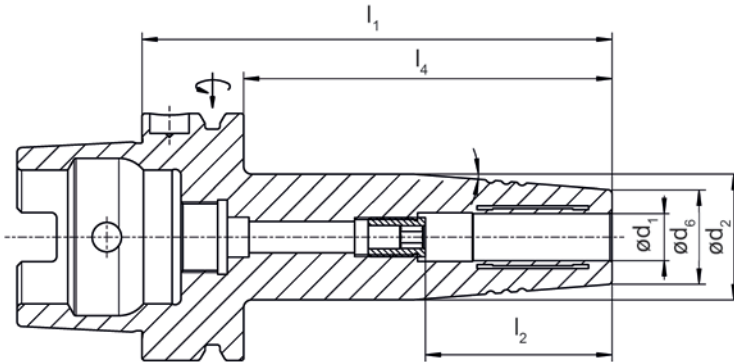

Bestellnummer Part number	d_1	d_2	d_3	d_6	l_1	l_2	l_4	Gewicht [kg] Weight [kg]	M_{min} [Nm]	System
HDS4X.HSKA063.06.080	6	27	27	21	80	38,2	54	0,9	16	HSK-A 63
HDS4X.HSKA063.06.120	6	27	27	21	120	38,2	94	1	16	HSK-A 63
HDS4X.HSKA063.08.080	8	27	27	21	80	38,2	54	0,9	23	HSK-A 63
HDS4X.HSKA063.08.120	8	27	27	21	120	38,2	94	1	23	HSK-A 63
HDS4X.HSKA063.10.085	10	32	32	24	85	42,7	59	0,9	45	HSK-A 63
HDS4X.HSKA063.10.120	10	32	32	24	120	43,2	94	1,1	45	HSK-A 63
HDS4X.HSKA063.12.090	12	32	32	24	90	47,7	64	0,9	90	HSK-A 63
HDS4X.HSKA063.12.120	12	32	32	24	120	47,7	94	1,1	90	HSK-A 63
HDS4X.HSKA063.14.090	14	34	34	27	90	48,7	64	1	110	HSK-A 63
HDS4X.HSKA063.14.120	14	34	34	27	120	48,7	94	1,2	110	HSK-A 63
HDS4X.HSKA063.16.095	16	34	34	27	95	53,2	69	1	185	HSK-A 63
HDS4X.HSKA063.16.120	16	34	34	27	120	53,2	94	1,2	185	HSK-A 63
HDS4X.HSKA063.20.100	20	42	42	33	100	55,7	74	1,2	330	HSK-A 63
HDS4X.HSKA063.20.120	20	42	42	33	120	55,7	94	1,4	330	HSK-A 63

Das Kühlmittelrohr ist nicht im Lieferumfang enthalten - bitte separat bestellen! Kapitel Zubehör
Coolant tube is not included - separate order required! Chapter Additional Equipment

H

Hydrodehnspannfutter slim4X

Hydraulic Expansion Toolholder slim4X

HDS4X

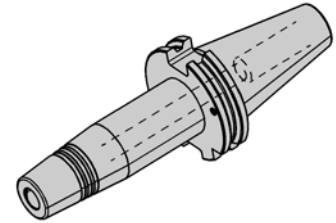
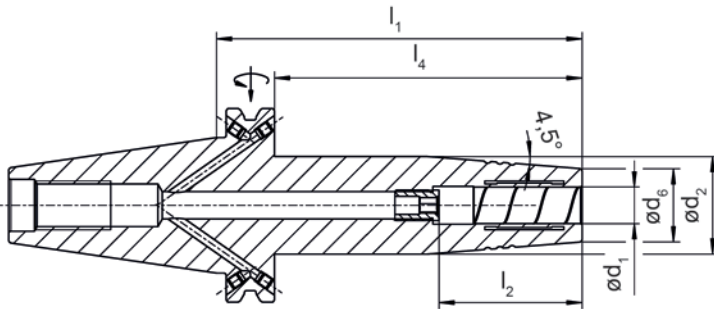

Bestellnummer Part number	d ₁	d ₂	d ₆	l ₁	l ₂	l ₄	Gewicht [kg] Weight [kg]	M _{min} [Nm]	System
HDS4X.SK40.06.080	6	27	21	80	36	61	1	16	SK 40
HDS4X.SK40.06.120	6	27	21	120	36	101	1,2	16	SK 40
HDS4X.SK40.08.080	8	27	21	80	36	61	1	23	SK 40
HDS4X.SK40.08.120	8	27	21	120	36	101	1,2	23	SK 40
HDS4X.SK40.12.080	12	32	24	80	47	61	1	90	SK 40
HDS4X.SK40.12.120	12	32	24	120	47	101	1,3	90	SK 40
HDS4X.SK40.20.080	20	42	33	80	52	61	1,2	330	SK 40
HDS4X.SK40.20.120	20	42	33	120	52	101	1,3	330	SK 40

H

Hydrodehnspannfutter zero

Hydraulic Expansion Toolholder zero

HDR

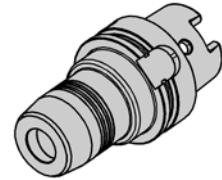
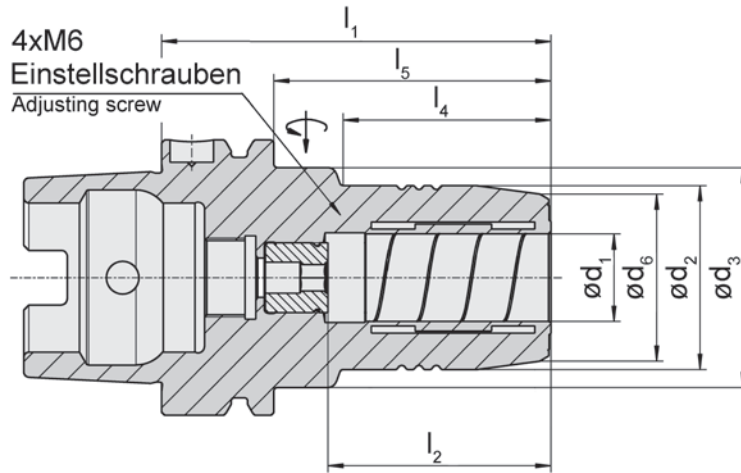

Bestellnummer Part number	d ₁	d ₂	d ₃	d ₆	l ₁	l ₂	l ₄	l ₅	Gewicht [kg] Weight [kg]	M _{min} [Nm]	System
HDR.HSKA040.12.080	12	32	33,5	28	80	46	48	60	0,5	90	HSK-A 40
HDR.HSKA040.20.100	20	42	53	38	100	51	47	-	1	330	HSK-A 40
HDR.HSKA050.12.085	12	32	40	28	85	46	44	59	0,8	90	HSK-A 50
HDR.HSKA063.12.085	12	32	50	28	85	46	40	59	1,1	90	HSK-A 63
HDR.HSKA063.20.090	20	42	50	38	90	51	48	64	1,3	330	HSK-A 63
HDR.HSKA063.32.125	32	64	75	60	125	61	63	99	2,7	650	HSK-A 63
HDR.HSKA100.12.095	12	32	50	28	95	46	47	66	2,6	90	HSK-A 100
HDR.HSKA100.20.105	20	42	50	38	105	51	59	76	2,8	330	HSK-A 100
HDR.HSKA100.32.110	32	64	75	60	110	61	62	81	3,8	650	HSK-A 100

Das Kühlmittelrohr ist nicht im Lieferumfang enthalten - bitte separat bestellen! Kapitel Zubehör
Coolant tube is not included - separate order required! Chapter Additional Equipment

Ersatzteile

Spare Parts

Hydrodehnspannfutter zero Hydraulic Expansion Toolholder zero	Spannschraube Clamping Screw	TORX PLUS®-Schlüssel TORX PLUS® Wrench
HDR.HSK...	6.075T15P	T15PQ

H

Hyrodehnspannfutter zero

Hydraulic Expansion Toolholder zero

HDR

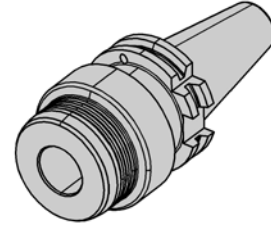
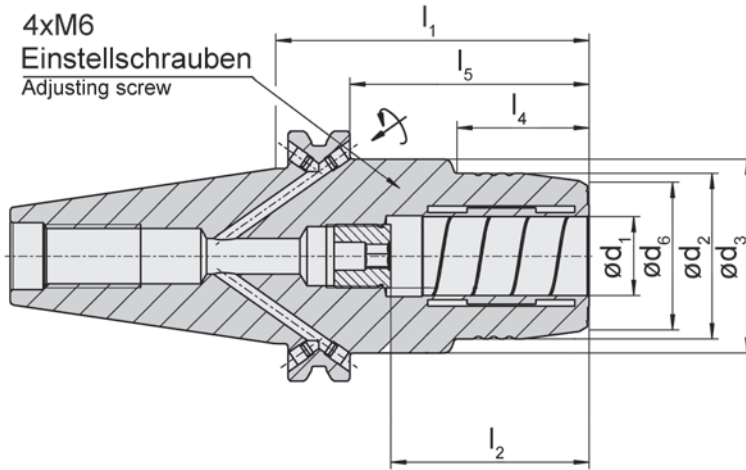

Bestellnummer Part number	d ₁	d ₂	d ₃	d ₆	l ₁	l ₂	l ₄	l ₅	Gewicht [kg] Weight [kg]	M _{min} [Nm]	System
HDR.SK40.12.081	12	32	49,5	28	80,5	46	31,5	61,5	1,4	90	SK 40
HDR.SK40.20.081	20	42	49,5	38	80,5	51	34	61,5	1,4	330	SK 40
HDR.SK40.32.081	32	63	80	60	80,5	61	25,5	61,5	2	650	SK 40
HDR.SK50.20.081	20	42	49,5	38	80,5	51	34	61,5	3,3	330	SK 50
HDR.SK50.32.103	32	64	70	60	103,2	-	61	81	4,4	650	SK 50

H

Ersatzteile

Spare Parts

Hyrodehnspannfutter zero Hydraulic Expansion Toolholder zero	Spannschraube Clamping Screw	TORX PLUS®-Schlüssel TORX PLUS® Wrench
HDR...	6.075T15P	T15PQ

Hyrodehnspannfutter zero

Hydraulic Expansion Toolholder zero

HDR

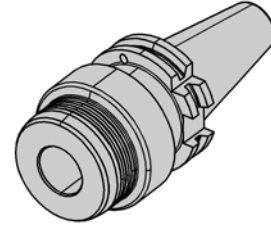
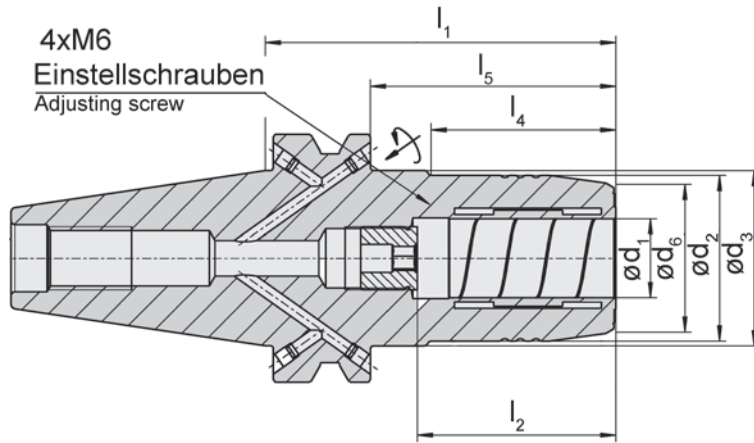

Bestellnummer Part number	d ₁	d ₂	d ₃	d ₆	l ₁	l ₂	l ₄	l ₅	Gewicht [kg] Weight [kg]	M _{min} [Nm]	System
HDR.BT30.20.090	20	42	44,5	37,5	90	51	47,5	67	1,5	330	JIS-BT 30
HDR.BT40.12.090	12	32	44,5	28	90	46	44,5	63	1,4	90	JIS-BT 40
HDR.BT40.20.090	20	42	44,5	38	90	51	47,5	63	1,5	330	JIS-BT 40
HDR.BT50.20.090	20	42	44,5	38	90	51	34	52	4	330	JIS-BT 50
HDR.BT50.32.120	32	64	70,5	60	120	61	62,5	82	5,3	650	JIS-BT 50

Ersatzteile

Spare Parts

Hyrodehnspannfutter zero Hydraulic Expansion Toolholder zero	Spannschraube Clamping Screw	TORX PLUS®-Schlüssel TORX PLUS® Wrench
HDR.B...	6.075T15P	T15PQ



Hyrodehnspannfutter zero

Hydraulic Expansion Toolholder zero

HDR

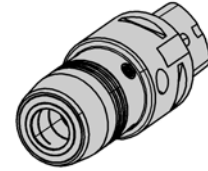
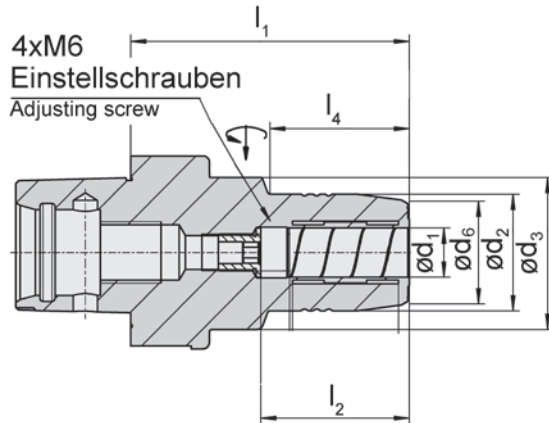

Bestellnummer Part number	d ₁	d ₂	d ₃	d ₆	l ₁	l ₂	l ₄	Gewicht [kg] Weight [kg]	M _{min} [Nm]	System
HDR.C4.12.081	12	32	32	28	81	46	47	0,7	90	PSC 40
HDR.C5.12.085	12	32	32	28	85	46	44	0,9	90	PSC 50
HDR.C5.20.090	20	42	42	38	90	51	52	1,05	330	PSC 50
HDR.C6.12.087	12	32	50	28	87	46	39	1,3	90	PSC 63
HDR.C6.20.097	20	42	42	38	97	51	55	1,6	330	PSC 63
HDR.C6.32.110	32	62,5	62,5	59	110	61	62	2,8	650	PSC 63

H

Ersatzteile

Spare Parts

Hyrodehnspannfutter zero Hydraulic Expansion Toolholder zero	Spannschraube Clamping Screw	TORX PLUS®-Schlüssel TORX PLUS® Wrench
HDR...	6.075T15P	T15PQ

Hyrodehnspannfutter zero-K

Hydraulic Expansion Toolholder zero-K

HDRK

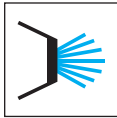
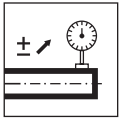

HSK-C

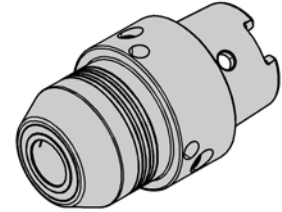
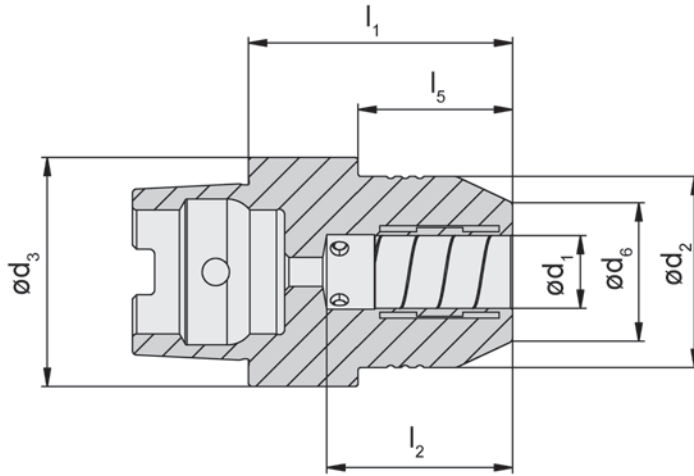

Bestellnummer Part number	d ₁	d ₂	d ₃	d ₆	l ₁	l ₂	l ₅	Gewicht [kg] Weight [kg]	M _{min} [Nm]	System
HDRK.HSKC063.20.073	20	52,5	52,5	38	72,5	51	42,5	1,25	82	HSK-C 63



Ersatzteile

Spare Parts

Hyrodehnspannfutter zero-K Hydraulic Expansion Toolholder zero-K	Spannschraube Clamping Screw	TORX PLUS®-Schlüssel TORX PLUS® Wrench
HDRK.HSKC063.20.073	6.075T15P	T15PQ

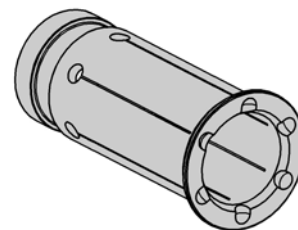
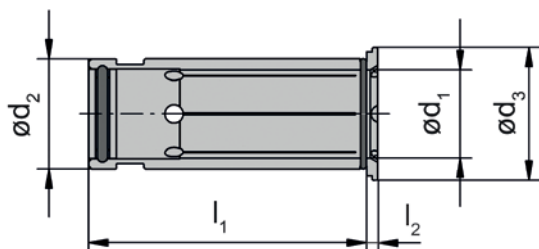
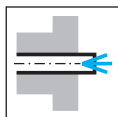

Bestellnummer Part number	d ₁	d ₂	l ₁	l ₂	d ₃	Gewicht [kg] Weight [kg]
HDZB.1203.KD	3	12	45	2	16,5	0,1
HDZB.1204.KD	4	12	45	2	16,5	0,1
HDZB.1205.KD	5	12	45	2	16,5	0,1
HDZB.1206.KD	6	12	45	2	16,5	0,1
HDZB.1208.KD	8	12	45	2	16,5	0,1
HDZB.2003.KD	3	20	50,5	2	24	0,1
HDZB.2004.KD	4	20	50,5	2	24	0,1
HDZB.2005.KD	5	20	50,5	2	24	0,1
HDZB.2006.KD	6	20	50,5	2	24	0,1
HDZB.2007.KD	7	20	50,5	2	24	0,1
HDZB.2008.KD	8	20	50,5	2	24	0,1
HDZB.2009.KD	9	20	50,5	2	24	0,1
HDZB.2010.KD	10	20	50,5	2	24	0,1
HDZB.2011.KD	11	20	50,5	2	24	0,1
HDZB.2012.KD	12	20	50,5	2	24	0,1
HDZB.2013.KD	13	20	50,5	2	24	0,1
HDZB.2014.KD	14	20	50,5	2	24	0,1
HDZB.2015.KD	15	20	50,5	2	24	0,1
HDZB.2016.KD	16	20	50,5	2	24	0,1
HDZB.3206.KD	6	32	60,5	3	35,5	0,3
HDZB.3208.KD	8	32	60,5	3	35,5	0,3
HDZB.3210.KD	10	32	60,5	3	35,5	0,3
HDZB.3212.KD	12	32	60,5	3	35,5	0,3
HDZB.3214.KD	14	32	60,5	3	35,5	0,3
HDZB.3216.KD	16	32	60,5	3	35,5	0,3
HDZB.3218.KD	18	32	60,5	3	35,5	0,3
HDZB.3220.KD	20	32	60,5	3	35,5	0,3
HDZB.3225.KD	25	32	60,5	3	35,5	0,3

Standard-Zwischenbüchse d₂ ≤ 12 mm nicht zum Rundrichten verwenden
Standard intermediate sleeve d₂ ≤ 12 mm do not use for round-straightening

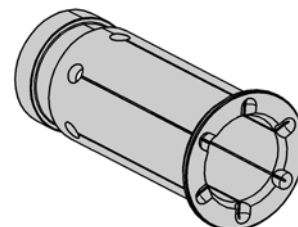
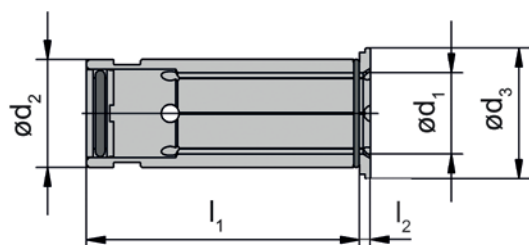
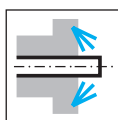

Bestellnummer Part number	d ₁	d ₂	l ₁	l ₂	d ₃	Gewicht [kg] Weight [kg]
HDZB.1203.PK	3	12	45	2	16,5	0,1
HDZB.1204.PK	4	12	45	2	16,5	0,1
HDZB.1205.PK	5	12	45	2	16,5	0,1
HDZB.1206.PK	6	12	45	2	16,5	0,1
HDZB.1208.PK	8	12	45	2	16,5	0,1
HDZB.2003.PK	3	20	50,5	2	24	0,1
HDZB.2004.PK	4	20	50,5	2	24	0,1
HDZB.2005.PK	5	20	50,5	2	24	0,1
HDZB.2006.PK	6	20	50,5	2	24	0,1
HDZB.2007.PK	7	20	50,5	2	24	0,1
HDZB.2008.PK	8	20	50,5	2	24	0,1
HDZB.2009.PK	9	20	50,5	2	24	0,1
HDZB.2010.PK	10	20	50,5	2	24	0,1
HDZB.2011.PK	11	20	50,5	2	24	0,1
HDZB.2012.PK	12	20	50,5	2	24	0,1
HDZB.2013.PK	13	20	50,5	2	24	0,1
HDZB.2014.PK	14	20	50,5	2	24	0,1
HDZB.2015.PK	15	20	50,5	2	24	0,1
HDZB.2016.PK	16	20	50,5	2	24	0,1
HDZB.3206.PK	6	32	60,5	3	35,5	0,3
HDZB.3208.PK	8	32	60,5	3	35,5	0,3
HDZB.3210.PK	10	32	60,5	3	35,5	0,3
HDZB.3212.PK	12	32	60,5	3	35,5	0,3
HDZB.3214.PK	14	32	60,5	3	35,5	0,3
HDZB.3216.PK	16	32	60,5	3	35,5	0,3
HDZB.3218.PK	18	32	60,5	3	35,5	0,3
HDZB.3220.PK	20	32	60,5	3	35,5	0,3
HDZB.3225.PK	25	32	60,5	3	35,5	0,3

Standard-Zwischenbüchse d₂ ≤ 12 mm nicht zum Rundrichten verwenden
Standard intermediate sleeve d₂ ≤ 12 mm do not use for round-straightening



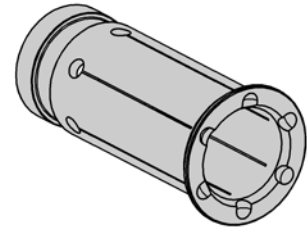
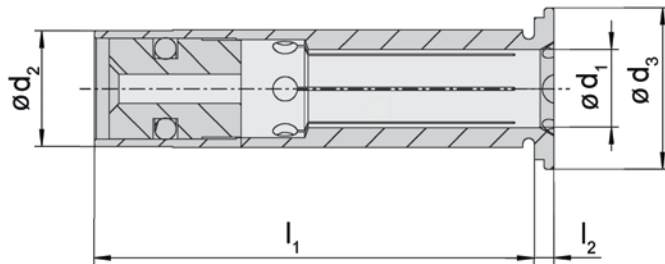
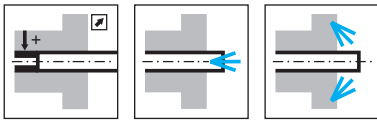

Bestellnummer Part number	d_1	d_2	l_1	l_2	d_3	Gewicht [kg] Weight [kg]
HDZB.1206.KDV	6	12	45	2	16,5	0,1
HDZB.1206.PKV	6	12	45	2	16,5	0,1
HDZB.1208.KDV	8	12	45	2	16,5	0,1
HDZB.1208.PKV	8	12	45	2	16,5	0,1

Durch die eingepasste Dichtscheibe kann die Längeneinstellung der Hydrodehnspannfutter nicht verwendet werden.
Durch verstärkten Bund auch bei $d_2 \leq 12$ mm in Rundlauf einstellbaren Hydrodehnspannfutter Typ HDR einsetzbar.
Due to the fitted collet, the length adjustment of the hydraulic expansion toolholder cannot be used.
Due to reinforced collar also applicable at $d_2 \leq 12$ mm for adjustable runout hydraulic expansion toolholder type HDR.

PZ

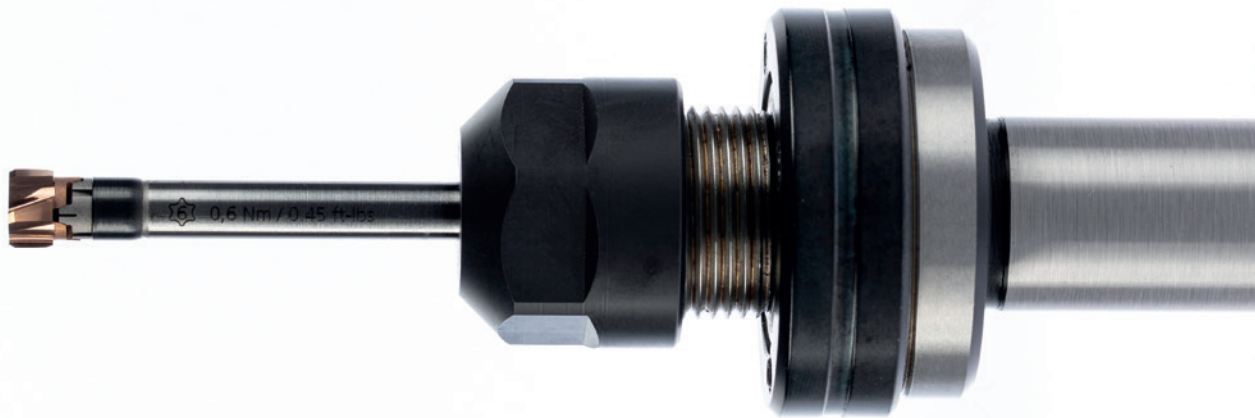

Pendelhalter

mit ER-Spannzangen

Floating holder

with Collet ER

I

Technische Hinweise
Technical Instructions

Seite/Page
225

Pendelhalter
Floating holder
PZ

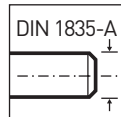

Seite/Page
226

Spannzange 62
Collet
Dichtscheibe 20
Sealing Disc

Seite/Page
227

für den Einsatz auf Drehmaschinen
for use on lathe



Mittels achsparallelem Pendelausgleich können Positionsfehler zwischen Werkstück und Werkzeug ausgeglichen werden.
Positional errors between workpiece and tool can be compensated by means of a float adjustment feature.

Vorgehensweise beim Einstellen der Federkraft

Durch Drehung der Justierschraube (1) im Uhrzeigersinn nimmt die Federkraft zu und der Pendelweg wird begrenzt. Auf Endlage gedreht, ist der Pendelhalter starr. Die Endlage ist Ausgangspunkt für die unten beschriebenen Einstellungen.

Procedure for adjusting the spring force

By turning the adjusting screw (1) clockwise, the spring force increases and the float travel is limited. Turned to the end position, the floating holder is rigid. The end position is the starting point for the settings described below.

Einstellung der Justierschraube ausgehend von Endlage

Starr: Justierschraube bis Endlage drehen

Hart: ¼ bis ½ Umdrehung zurück drehen

Mittel: 1 ±¼ Umdrehungen zurück drehen

Weich: Das aufgenommene Werkzeug sollte mit möglichst geringem Ausgleichswiderstand selbständig in die Mittelachse zurückfedern. Bei weicher Einstellung ist der Einfluss des Werkzeuggewichts individuell zu berücksichtigen.

Adjusting the adjusting screw starting from the end position

Rigid: Turn the adjustment screw to the end position

Hard: Turn back ¼ to ½ turn

Medium: Turn back 1 ±¼ turns

Soft: The picked-up tool should automatically spring back to the central axis with as little compensation resistance as possible. With a soft setting, the influence of the tool weight must be taken into account.

Hinweise

- Bei kleinen Bohrungsdurchmessern bis ca. Ø15 mm empfehlen wir eine weiche Einstellung.
- Bei vorhandener Y-Achse empfehlen wir das Werkzeug zusätzlich < 10 µm zur Spindelachse auszukreisen.
- Der Anschnittwinkel von Reibwerkzeugen für den URMA-Pendelhalter sollte nicht größer als 45° sein.
- Die Einstellung des Pendelmechanismus ist applikationsabhängig und kann variieren.
- Mit Pendelhalter müssen gegebenenfalls die Schnittdaten angepasst werden.
- Alle Angaben sind Richtwerte und beziehen sich auf das URMA-Pendelfutter.

Notes

- For small bore diameters up to approx. Ø15 mm, we recommend a soft setting.
- If a Y-axis is available, we recommend concentricity is set < 10 µm to the spindle axis.
- The taper lead angle of reaming tools for URMA floating holder should not over 45°.
- The setting of the floating mechanism depends on the application and may vary.
- Cutting data may have to be adjusted with the floating holder.
- All data are approximate values and refer to the URMA floating chuck.

Pendelhalter

Floating holder

PZ

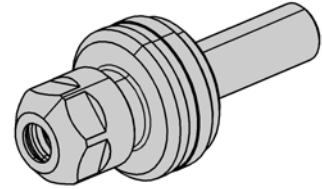
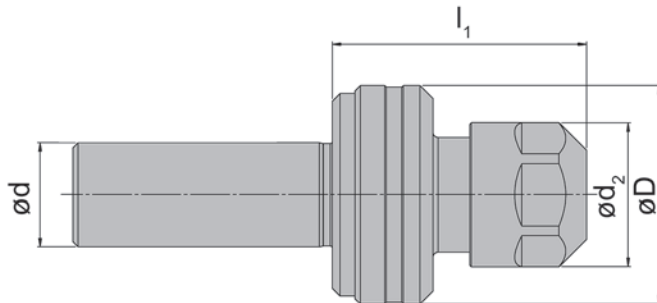
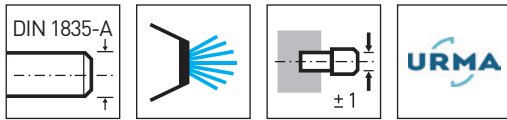

Bestellnummer Part number	l_1	d	D	d_2	Größe Size
PZ60.16.16.044	44	16	42	28	16
PZ60.16.20.044	44	20	42	28	16

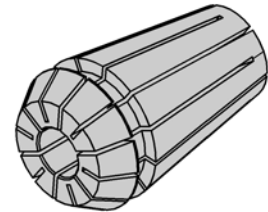
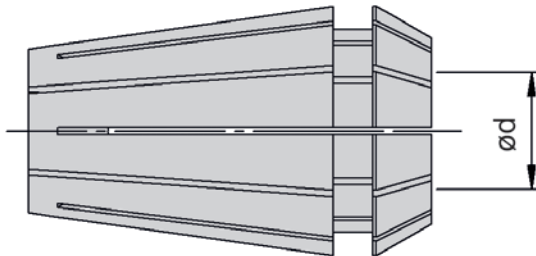

Bestellnummer Part number	d	Größe Size
62 16 06	6	16
62 16 08	8	16
62 16 10	10	16

Dichtscheibe
Sealing disc

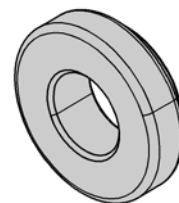
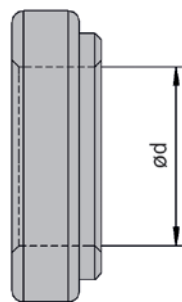

Bestellnummer Part number	d	Größe Size
20 10721 060	6	16
20 10721 080	8	16
20 10721 100	10	16



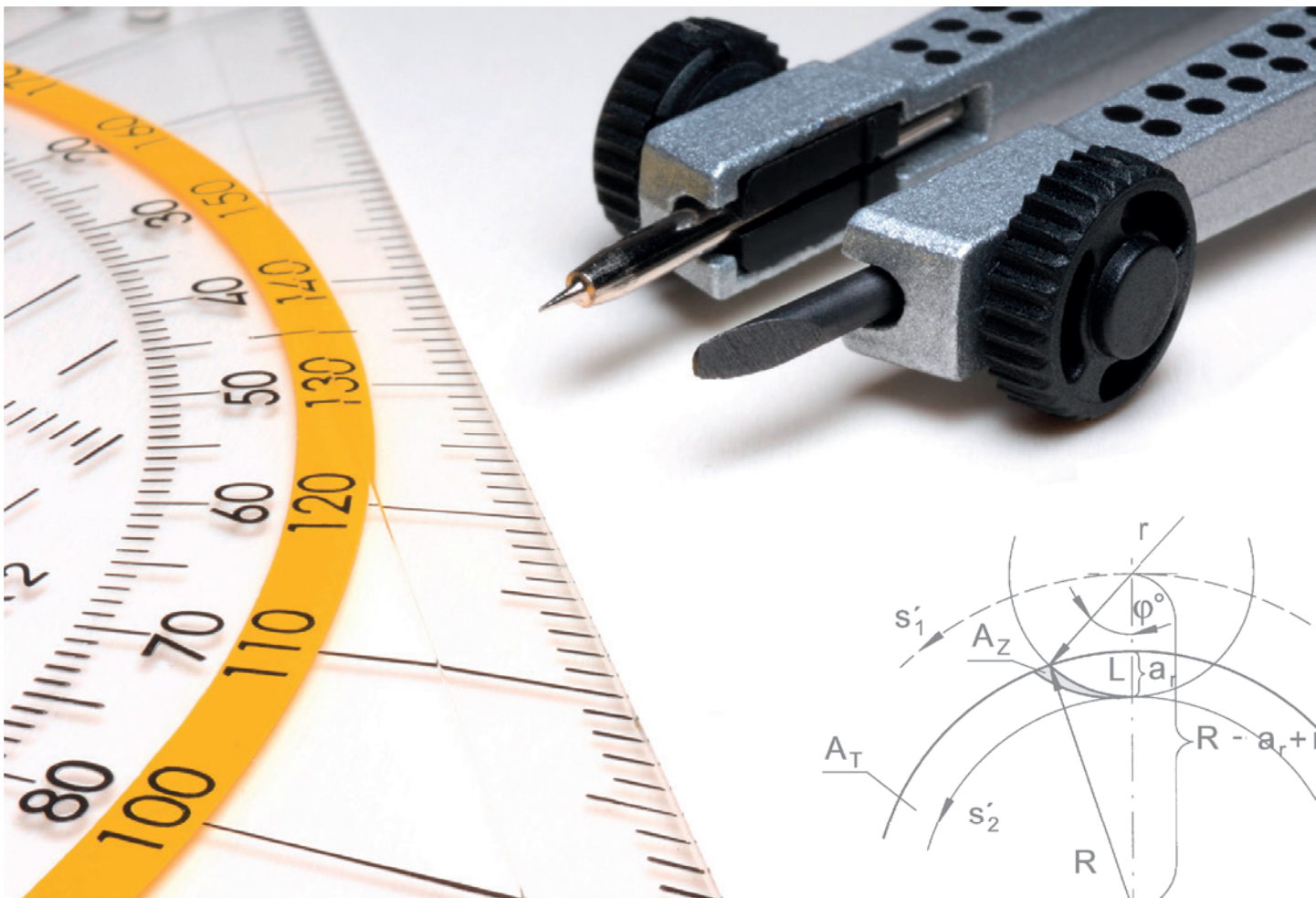

Inhalt/Summary	Seite/Page
Anzugsmomente Torque of Screwdriving Equipment	230
Zubehör Additional Equipment	231-233

Nachstehende Drehmomente sind für die Spannschrauben zulässig. Wir empfehlen keine zusätzlichen Gleitmittel wie Kupferpaste oder ähnliches für die Schrauben zu verwenden.

Following torques are allowed for screws of inserts. We recommend using no additional gliding means (such as copper paste) for screws.

Typ Type	Schraube Screw	M _d Nm	Größe Size	Schlüssel Clamping wrench	Klinge Blade	Drehmoment- schlüssel Torque wrench
B105	6.075T15P	5	T15P	T15PQ	D T15 PK	D 28 VL
B110	6.075T15P	5	T15P	T15PQ	D T15 PK	D 28 VL
B117.DD...3	5.12T20P	6	T20P	T20PQ	DT20PK	D 515 QL
B117.DD...4-6	6.17T20P	7	T20P	T20PQ	DT20PK	D 515 QL
BKT105	6.075T15P	5	T15P	T15PQ	D T15 PK	D 28 VL
BKT110	6.075T15P	5	T15P	T15PQ	D T15 PK	D 28 VL
BKT356	5.12T20P	5,5	T20P	T20PQ	D T15 PK	D 515 QL
MDR.016	C009000	0,7	T6	T6L	D T6 K	D 041 VL
MDR.016...Z	C009022	4	T15	T15Q	D T15 K	D 28 VL
MDR.019	C009000	0,7	T6	T6L	D T6 K	D 041 VL
MDR.019...Z	C009023	6	T20	T20Q	D T20 Q	D515QL
MDR.024	C009001	1,5	T8	T8L	D T8 K	D 15 VL
MDR.024-029...Z	C009024	16	T30	T30Q	-	-
MDR.029	C009001	1,5	T8	T8L	D T8 K	D 15 VL
MDR.036...Z	C009025	18	T30	T30Q	-	-
MDR.036	C009001	1,5	T8	T8L	D T8 K	D 15 VL
MDR.044	C009002	1,5	T8	T8L	D T8 K	D 15 VL
MDR.052	C009002	1,5	T8	T8L	D T8 K	D 15 VL
MDR.061	C009002	1,5	T8	T8L	D T8 K	D 15 VL
MDR.08	C009051	0,6	T6	T6L	D T6 K	D 041 VL
MDR.081	C009004	3,5	T15	T15Q	D T15 K	D 15 VL
MDR.10	C009052	0,9	T7	T7L	D T7 K	D 041 VL
MDR.101	C009004	3,5	T15	T15Q	D T15 K	D 15 VL
MDR.11...D	C009053...	1,4	T9	T9L	D T9 K	D 15 VL
MDR.11...S	C009053B	1,4	T9	T9L	D T9 K	D 15 VL
MDR.121	C009004	3,5	T15	T15Q	D T15 K	D 15 VL
MDR.13...D	C009054...	2	T10	T10L	D T10 K	D 15 VL
MDR.13...S	C009054B	2	T10	T10L	D T10 K	D 15 VL
MDR.141	C009004	3,5	T15	T15Q	D T15 K	D 15 VL
MDR.150	C002207	8	4	SW4DIN911	D SW 4,0 K	D 28 VL
MDR.170	C002207	8	4	SW4DIN911	D SW 4,0 K	D 28 VL
MDR.190	C002207	8	4	SW4DIN911	D SW 4,0 K	D 28 VL



D 041 VL
0,4-1 Nm



D 15 VL
1-5 Nm



D 28 VL
2-8 Nm



ED 28 VL
für / for
D 041 VL / D 15 VL / D 28 VL

Drehmoment-Schraubendreher mit Skala

- mit variabler Einstellmöglichkeit
- numerische Drehmoment-Anzeige in Fensterskala
Drehmoment stufenlos einstellbar mit Einstellwerkzeug Torque-Setter (im Lieferumfang enthalten).
Ergonomischer Mehrkomponentengriff, extrem handlich durch leichte und kompakte Bauweise. Klicksignal beim Erreichen des eingestellten Drehmomentwertes.
(Normen: EN ISO 6798, BS EN 26789, ASME B107.14.M.)
(Genauigkeit: $\pm 6\%$, rückführbar auf nationale Normale)

Torque screwdriver with scale

- variable torque setting
- adjusted torque is shown on display
The Torque can be adjusted with a special torque setter (included).
Ergonomic form gives perfect handling abilities. Audible signal when set torque is reached.
(Standard: EN ISO 6798, BS EN 26789, ASME B 107.14.M.)
(Precision: $\pm 6\%$)

Einstellwerkzeug für Drehmoment-Schraubendreher

Griff: Celluloseacetat mit microfeiner Oberflächenstruktur
Klinge: Achtkantklinge, durchgehend gehärtet, verzinkt

Device for setting the required torque.
Handle: Celluloseacetat with micro structured surface
Blade: Octogonal (8 flats) blade, hardened galvanized



D T6 K
D T7 K
D T8 K
D T9 K
D T10 K
D T15 K

für / for
D 041 VL / D 15 VL / D 28 VL



Wechselklinge für Torx Schrauben

Klinge: Hochwertiger Chrom-Vanadium-Molybdän Stahl, durchgehend gehärtet, mattverchromt
Wiha Chrom Top-Klingenspitze garantiert höchste Maßhaltigkeit.
Farbcodierung dunkelgrün
Anwendung: Kontrolliertes Verschrauben bei vorgegebenem Drehmoment, in Kombination mit einem Wiha Drehmomentgriff.

Blade for Torx screws

Blade: High quality Chrome-Vanadium steel, through hardened, chrome plated.
Wiha Chrome Blade guarantees maximum precision.
Color code dark green
Utilization: Controlled screw setting with definite torque in combination with Wiha torque screwdriver handle.





D 515 QL
5-15 Nm

Drehmoment-Schraubendreher mit Skala

- mit variabler Einstellmöglichkeit
- numerische Drehmoment-Anzeige in Fensterskala

Drehmoment stufenlos einstellbar mit Einstellwerkzeug Torque-Setter (im Lieferumfang enthalten).

Ergonomischer Mehrkomponentengriff, extrem handlich durch leichte und kompakte Bauweise. Klicksignal beim Erreichen des eingestellten Drehmomentwertes.

(Normen: EN ISO 6798, BS EN 26789, ASME B107.14.M.)
(Genauigkeit: $\pm 6\%$, rückführbar auf nationale Normale)

Torque screwdriver with scale

- variable torque setting
- adjusted torque is shown on display

The Torque can be adjusted with a special torque setter (included). Ergonomic form gives perfect handling abilities. Audible signal when set torque is reached.

(Standard: EN ISO 6798, BS EN 26789, ASME B 107.14.M.)
(Precision: $\pm 6\%$)



ED 515 QL

für / for
D 515 QL

Einstellwerkzeug für Drehmoment-Schraubendreher

Griff: Celluloseacetat mit microfeiner Oberflächenstruktur

Klinge: Achteckklinge, durchgehend gehärtet, verzinkt

Device for setting the required torque.

Handle: Celluloseacetat with micro structured surface

Blade: Octogonal (8 flats) blade, hardened galvanized



DT 15 Q

DT 20 Q

DT 30 Q

für / for
D 515 QL



Wechselklinge für TORX Schrauben

Klinge: Hochwertiger Chrom-Vanadium-Molybdän Stahl, durchgehend gehärtet, mattverchromt
Wiha Chrom Top-Klingenspitze garantiert höchste Maßhaltigkeit.
Farbcodierung dunkelgrün

Anwendung: Zum kontrollierten Verschrauben bei vorgegebenem Drehmoment, in Kombination mit einem Wiha Drehmomentgriff.

Blade for TORX screws

Blade: High quality Chrome-Vanadium steel, through hardened, chrome plated.

Wiha Chrome Blade guarantees maximum precision.
Color code dark green

Utilization: Controlled screw setting with definite torque in combination with Wiha torque screwdriver handle.



DT 20 PQ

für / for
D 515 QL



Plus

Wechselklinge für TORX PLUS® Schrauben

Klinge: Hochwertiger Chrom-Vanadium-Molybdän Stahl, durchgehend gehärtet, mattverchromt
Wiha Chrom Top-Klingenspitze garantiert höchste Maßhaltigkeit.

Farbcodierung dunkelgrün

Anwendung: Zum kontrollierten Verschrauben bei vorgegebenem Drehmoment, in Kombination mit einem Wiha Drehmomentgriff.

Blade for TORX-Plus® screws

Blade: High quality Chrome-Vanadium steel, through hardened, chrome plated.
Wiha Chrome Blade guarantees maximum precision.
Color code dark green

Utilization: Controlled screw setting with definite torque in combination with Wiha torque screwdriver handle.



T15PW
T20PW
T25PW



Plus

Stiftschlüssel für TORX PLUS® Schrauben

Anwendung: Für alle TORX PLUS® Schraubaufgaben
Achtung: TORX PLUS®-Schlüssel passen NICHT in TORX Schrauben

Wrench for TORX PLUS® Screws

Utilization: For all kind of using TORX PLUS® Screws
Attention: TORX PLUS®-Wrench does NOT fit for TORX screws



HDZBZ

Büchsenzieher

Demontagewerkzeug für Zwischenbüchsen mit Außendurchmesser d_1 von Ø12 mm bis Ø32 mm (HDZB.12... bis HDZB.32...)

Sleeve Remover

Disassembly tool for intermediate sleeves outer diameter d_1 from Ø12 mm to Ø32 mm (HDZB.12... to HDZB.32...)



Kühlmittelrohr für System-Aufnahme
Coolant tube for System Holer

- 020.4012.1306 HSK-A 40
- 020.5016.1307 HSK-A 50
- 020.6318.1308 HSK-A 63
- 020.0024.1310 HSK-A 100



Typ Type	Seite Page
020	89
20	227
22	86, 92
23	96
62	227
105	55, 56, 68-76, 97-102
110	77
A110	103
A315	104
B05	64
B12	202
B13	201
B21	91
B105	65, 66
B110	67
B117	49, 50
BD	199
BH	198
BKT	85, 87, 88, 93-95
BT	200

Typ Type	Seite Page
C11	84
D11	84, 90
D117	51
D1122	11-25
DDM	26-37
DR large	166, 167
DR medium	107, 126-131, 136, 140-145
DR small	107, 112-117, 120
H11	84, 90
HDC	208, 209
HDE	210-212
HDR	215-218
HDRK	219
HDS4X	213, 214
HDZB	220-222
HSK-A 11/T11	84, 90
MDR	132-135, 146-148, 168
MDR small	118, 119
PZ	226
VDR	149-154, 169-173



**FINDEN SIE JETZT IHRE
PASSENDE WERKZEUGLÖSUNG.**

FIND YOUR RIGHT
TOOLING SOLUTION NOW.

horn-group.com

DEUTSCHLAND, STAMMSITZ

GERMANY, HEADQUARTERS

—

Hartmetall-Werkzeugfabrik

Paul Horn GmbH

Horn-Straße 1

72072 Tübingen

Tel +49 7071 7004-0

Fax +49 7071 72893

info@de.horn-group.com

horn-group.com